

**PIXELBOY'S
UNOFFICIAL
COMPANION GUIDE
TO**



**FOR
GAME BOY® ADVANCE**

- Version 1.1 -

This is an **unofficial** (and unauthorized) companion guide for the Game Boy® Advance version of *Activision® Anthology*.

The author of this document is not affiliated in any way with Aspyr Media Inc. or Activision Inc.

The author cannot claim any copyright over the material in this guide, since it is a compilation of texts and images which are already copyrighted by other parties. Modifying any part of this document without the approval of the author is prohibited.

This guide is meant to be distributed in PDF format, free of charge. If you paid anything to acquire this guide, well, it sucks to be you.

Activision Anthology for Game Boy® Advance was developed, published and distributed by Aspyr Media Inc., under license from Activision Publishing, Inc. © 2003 Activision, Inc. and its affiliates. All rights reserved.

All trademarks are properties of their respective owners.

TABLE OF CONTENTS

	<u># of players</u>	<u>Page</u>
– Preface		6
– Activision® Decathlon	1 to 4	7
– Barnstorming™	1	11
– Baseball	1 or 2	15
– Beamrider™	1	19
– Bloody Human Freeway™	1	23
– Boxing	1 or 2	25
– Bridge	1	29
– Checkers	1 or 2	35
– Chopper Command™	1 or 2	39
– Climber 5	1	43
– Cosmic Commuter™	1	47
– Crackpots™	1 or 2	51
– Dolphin™	1 or 2	55
– Dragster™	1 or 2	61
– Enduro™	1	65
– Fishing Derby™	1 or 2	69
– Freeway™	1 or 2	73
– Frostbite™	1 or 2	77
– Grand Prix™	1	81
– H.E.R.O.™	1	85
– Ice Hockey	1 or 2	89
– Kabobber™	1 or 2	93
– Kaboom!™	1 or 2	99
– Keystone Kapers™	1	103
– Laser Blast™	1	107
– Megamania™	1 or 2	111
– Oink!™	1 or 2	115
– Okie	1	119
– Oystron	1	123
– Pitfall!™	1	127
– Pitfall II – Lost Caverns™	1	131
– Plaque Attack™	1 or 2	135
– Pressure Cooker™	1 or 2	139
– Private Eye™	1	145
– River Raid™	1 or 2	151

TABLE OF CONTENTS (cont.)

– River Raid II™	1 or 2	155
– Robot Tank™	1	159
– Seaquest™	1 or 2	165
– Skate Boardin'™	1	169
– Skeleton+	1	173
– Skiing	1	177
– Sky Jinks™	1	183
– Space Shuttle – A Journey Into Space™	1	187
– Space Treat Deluxe	1	209
– Spider Fighter™	1	213
– Stampede™	1	217
– Starmaster™	1	221
– Tennis	1 or 2	229
– Thwacker	1	233
– Title Match Pro Wrestling™	1 or 2	235
– Tomcat – The F-14 Fighter Simulator™	1	241
– Unknown Activision® Prototype #1	1	249
– Unknown Activision® Prototype #2	1	251
– Vault Assault	1	253
– Venetian Blinds	N/A	255
– Video Euchre	1	257
– Appendix A: Complementary documents		
– Basic card game rules of Bridge		267
– <i>How Your Partner Bids on Bridge by Activision®</i>		275
– <i>The Power of Starmaster™</i>		283
– Supplementary tips and cheats		289
– Appendix B: Game maps		
– Game maps of <i>H.E.R.O.™</i>		293
– Game map of <i>Pitfall!™</i>		306
– Game map of <i>Pitfall II – Lost Caverns™</i>		309
– Game maps of <i>Private Eye™</i>		310
– Game map of <i>Skate Boardin'™</i>		319
– Appendix C: Requirements for earning patches		323
– Appendix D: Acknowledgements and credits		327

PREFACE

Greetings, fellow retro gaming fan.

If you're reading this right now, it can mean one of two things: You already own *Activision® Anthology* for Game Boy® Advance and you're looking for information on a certain game, or you do not own the compilation, but are considering getting it in the not-so-distant future. In any case, you've come to the right place, as this guide contains the instruction manuals for all 56 games of this wonderfully emulated Atari® 2600 compilation, with some bonus material thrown in for good measure.

Why did I prepare this companion guide? Well, since the instruction manual included with the GBA cartridge does not contain any playing instructions for any of the 56 games, this guide is meant to be a complement to that manual.

You can, of course, consult the virtual manuals encoded into the game cartridge, but there are two problems with this: 1) You cannot consult these virtual manuals while you are playing, and 2) the manuals are plain texts with no screenshots or any other kind of supporting illustration.

This guide is closer to the original manuals of the Atari® 2600 games, with annotated screenshots and other important pictures and diagrams included. You will also find some extra material in Appendix A, namely some transcriptions of official companion booklets, as well as extra tips and cheats; the basic rules for *Bridge* are also included, just in case you want to try the card game but don't know the rules. Appendix B contains complete maps for *H.E.R.O.™*, *Pitfall!™*, *Pitfall II™*, *Private Eye™* and *Skate Boardin'™*. Also be sure to check out Appendix C for a quick list of the tasks you need to accomplish in order to earn virtual patches, and Appendix D for acknowledgements to all the people that need to be credited in the development of this document.

You may notice that the parts of the manuals that refer to Atari® 2600 buttons and switches have been replaced by their GBA button and D-pad equivalents. I did this for clarity purposes. References to the official manual of *Activision® Anthology* relative to linking up two GBAs with a Link Cable for two-player games were also added where it was applicable. If you compare the manuals in this document to the real manuals of the Atari® 2600 games, you may notice that I took some liberties in some places (such as added screenshots for *Cosmic Commuter™*, *Pitfall II™* and *Private Eye™*, among others) but those are always minor details.

I hope this guide will be useful to you. If you want to print it out for personal use, be sure to use regular paper (8.5 x 11 inches). It is also recommended to print in double-sided (recto-verso) mode.

Happy retro gaming!

Pixelboy.

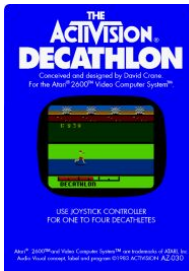

ACTIVISION® DECATHLON

by David Crane

1 to 4 players (alternating)

© 1983 Activision Inc.

BASICS

Requiring discipline and sweat, stamina and speed, with muscles opposing muscles, compete in the most celebrated game of the Olympics: the ten events of the decathlon. Earn points for each event. Highest final score wins!

1. Please refer to the official manual of *Activision® Anthology* for Game Boy® Advance to review how to setup and select this game.
2. One to four contestants may compete, **taking turns** using the D-Pad and A button to play.
3. **Choose the number of contestants** by holding the L button and pressing UP on the D-Pad. You can also select individual events this way (See "Practice Heats" under "Special Highlights".)
4. **The difficulty switches are not used.** In other words, holding the L button and pressing LEFT or RIGHT on the D-Pad produces no effect.
5. **To begin the Games**, press the SELECT button.
6. How to play.
 - Continually move the D-Pad to the left and right to **run** or to **approach** the scratch line.
 - Press the A button to **jump, throw, hurdle, put the shot** or **vault**.
 - Total scores may be reviewed by pressing the A button **before** any event.
7. **The ten decathlon events are:** 100-Meter Dash, Long Jump, Shot Put, High Jump, 400-Meter Race, 110-Meter Hurdles, Discus Throw, Pole Vault, Javelin Throw and 1500-Meter Race.
8. **Contestants compete separately** in each event. Some events allow more than one attempt per contestant. When all contestants have completed an event, the next event automatically appears.
9. **Scoring.** Contestants earn points for each event. Screen displays the contestant's **event score** following the event, and then each contestant's **total score** is displayed. For the events that allow multiple attempts, only the highest **event score** is added to the total score.
10. **End of competition.** When the last contestant has completed the 1500-Meter run, The Activision Decathlon is concluded. Final scores for all contestants are displayed.

SPECIAL HIGHLIGHTS

Speed Gauge. Registers your relative **running speed** or **approach speed** throughout each event. The faster or quicker you move the D-Pad, the closer the gauge measures to the **right-hand limit**.

Real-Time Clock. Counts the minutes, seconds and fractions of seconds on the screen during all **races**.

Distance Measure. In each throwing event – Shot Put, Discus, and Javelin – the distance of each throw displays on the screen in meters. The distance measure also calculates how far you jump in the Long Jump.

Scratch Line. Don't cross the scratch line before pressing the A button to jump the Long Jump, throw the javelin, put the shot or hurl the discus. "Scratching" disqualifies the attempt, resulting in a score of 0.

Musical Tribute. Each time you score 1000 or more points in any event, a musical tribute recognizes your special accomplishment.

Current Contestant. A small square enclosing the number 1, 2, 3 or 4 reminds all contestants which decathlete is currently competing.

Practice Heats. All decathletes can practice any event before the Games. Hold down the L button and press UP on the D-Pad until the name of each event appears on the screen one at a time. When the event you want to practice appears, release the L button and press the SELECT button.

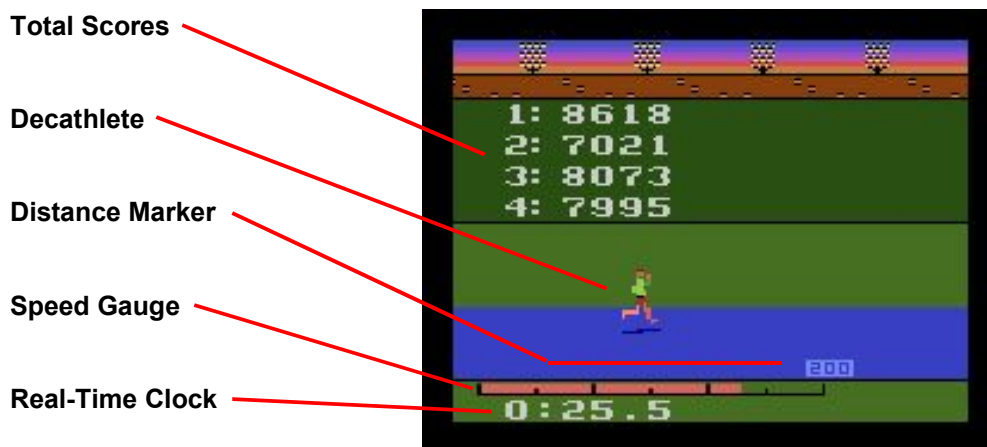

EVENTS

100-Meter Dash. Just one opportunity to sprint from start to finish. Explode out of the starting blocks, then give it your all by moving the D-Pad as fast as you can for the entire dash. When you see the 100 meter marker, find a final burst of strength. The quicker your time, the higher your points. Every 1/100 of a second matters.

Long Jump. Each decathlete gets three jumps. You begin with a running start of 30 meters. Press the A button **just before** you reach the scratch line to jump. The faster you are running when you jump, the farther you'll go. Your longest jump earns the most points.

Shot Put. All contestants "put" the shot three times. Move the D-Pad as rapidly as you can to approach the scratch line, then press the A button. The quicker your approach, the farther your "put" will go, and the more points you'll earn.

High Jump. You are allowed a maximum of three attempts at each height. Your turn ends when you miss the same height three times. There is a 30 meter approach run to the high jump standards. Press the A button to jump. Each time you successfully "clear" a height, the crossbar automatically raises. The higher you jump, the more points will be added to your total.

400-Meter Race. It's one middle-distance race. Nothing to throw or jump. Pick your feet up and put 'em down as fast as you can. The distance markers, set every 100 meters, show how far you've run. The faster you complete the race, the more points you'll earn.

110-Meter Hurdles. There are ten hurdles to jump over that are positioned at 10 meter intervals. Run by moving the D-Pad, and jump the hurdles by pressing the A button. You won't be disqualified for 'spilling' a hurdle, but it will slow you down. And that's important, because the faster you complete the race, the more points you are awarded.

Discus Throw. You get three throws, but don't forfeit any of them by "scratching". The approach to the scratch line is just a few feet, so start moving the D-Pad as fast as possible before pressing the A button to hurl the discus. The farther the throw, the greater the points awarded.

Pole Vault. Each vaulter gets a maximum of three tries at each height. Turn ends when you miss the same height three times. Run to the vault pit and **plant your pole** by pressing the A button. Continue to move the D-Pad **as you vault** and, just at the peak, press the A button again to release the vaulting pole. Each time you "clear" a height, the crossbar automatically raises. The higher you vault, the more points you'll get.

Javelin Throw. All contestants throw the javelin three times. Run to the scratch line and press the A button to throw the javelin. The farthest of your three throws earns the most points. There's only one event left, so give this one your all.

1500-Meter Race. Each decathlete gets one chance to score well in the final event... you'd be too exhausted to race this one twice. Maintain a steady pace for the first 1300 meters and then sprint to the finish. Distance markers are placed every 100 meters, so you'll know how far the finish line is at all times. The faster you complete the race, the higher the number of points you'll earn. **Good luck!**

THE ACTIVISION® DECATHLON CLUB

If your final score is from 8,600 to 8,999 points, then step up to the first award level and receive your Bronze Medal patch. Let all contestants take special notice if you scored from 9,000 to 9,999 points, and climb to the second award level to receive your spirited Silver Medal patch. Stand at the top award level, where only champions have stood, if you score 10,000 or more points, and be presented with the glorious Gold Medal patch.

David Crane's Personal Best Event Scores

EVENT	SCORE	PERFORMANCE
100-Meter Dash	991	10.29 seconds
Long Jump	1148	8.66 meters
Shot Put	949	17.81 meters
High Jump	1025	2.2 meters
400-Meter Race	989	46.2 seconds
110-Meter Hurdles	937	14.19 seconds
Discus Throw	1052	60.75 meters
Pole Vault	1052	5.0 meters
Javelin Throw	996	80.68 meters
1500-Meter Race	994	03:41.00
TOTAL	10133 points	

WIN THE GOLD MEDAL PATCH

Tips from David Crane, designer of The Activision® Decathlon.

David Crane is a multiple award-winning senior designer at Activision. Recognized as one of the premier designers by the video game industry, David has created Dragster®, Fishing Derby®, Laser Blast®, Grand Prix™, Freeway®, Pitfall!™ and now The Activision® Decathlon.

"It won't take you very long to realize that The Activision® Decathlon is very physically demanding. Therefore, the best tip I can give you is to **pace yourself**. It won't do you any good to use up all of your energy in the early events, only to become too tired to complete the final 1500-meter run.

"Another characteristic of The Activision® Decathlon is balance. Remember that every event adds to your final score equally. You must excel in all events, so practice those that you are weakest at.

"Also, watch the speed gauge to measure your progress **as you compete**. If you can keep the red speed bar at 5/6 of the distance towards the right limit of the gauge throughout a race, or at that level when you jump or throw, then you'll score close to 1,000 points and will be on your way to winning the gold.

"But most important, enjoy yourself. Compete at your absolute best and send me a scorecard telling me how your progress is going. I'd love to know how I compare."

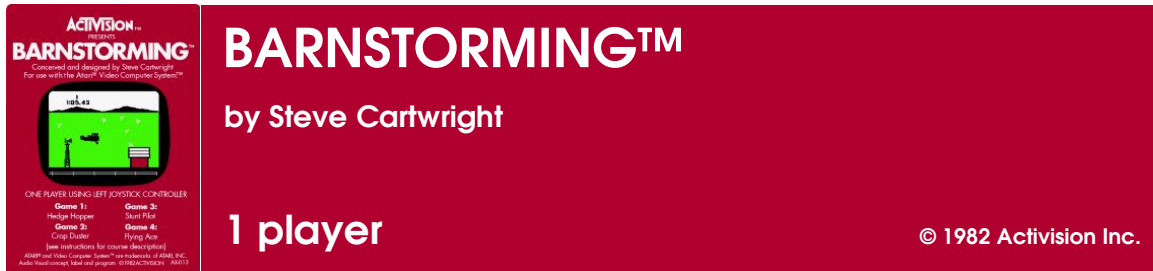

Pull on your goggles and check out your controls. You're about to embark on a daredevil flight through the wild blue yonder. But before you take off, take a minute to read over these instructions. You'll be glad you did.

BARNSTORMING™ BASICS

1. Please refer to the official manual of *Activision® Anthology* for Game Boy® Advance to review how to setup and select this game.
2. **Difficulty switches.** The **left** difficulty switch (hold the L button and press LEFT on the D-Pad) in the **A** position will **lower** the clearance heights of the barns, the **B** position is normal. The **right** difficulty switch (hold the L button and press RIGHT on the D-Pad) in the **A** position will add more geese, the **B** position is normal.
3. **Game Select.** Hold the L button, and press UP on the D-Pad to select a game:

Game 1:	Hedge Hopper	(Fly through 10 barns, fixed course)
Game 2:	Crop Duster	(Fly through 15 barns, fixed course)
Game 3:	Stunt Pilot	(Fly through 15 barns, fixed course, different than Game 2)
Game 4:	Flying Ace	(Fly through 25 barns, a new course each time you select Game 4)
4. The object of the game is to fly through a set number of barns in the shortest possible time (elapsed time indicated at top of screen).
5. **To take off,** simply press the A button, and press UP on the D-Pad to climb.
6. **Once airborne,** the A button acts as your throttle: press it for greater speed, release it to slow down. To increase your altitude, press UP on the D-Pad, and, to descend, press DOWN.
7. **Scoring.** Each time you make it through a barn, your barn count number (upper left corner of screen) will decrease by one. If you miss a barn, your barn count will remain the same and you will have to fly further to reach an additional barn. When your barn count reaches zero, the game is ended.

GETTING THE FEEL OF BARNSTORMING™ BY ACTIVISION®

Just as in flying a real biplane, you'll need to get the "feel" of the controls. The better you get at adjusting your throttle and handling the D-Pad, the better your chances to become a "Flying Ace".

You needn't worry about stalling out in midair. Your throttle is set to maintain a minimum speed even when you release the A button. The game is mastered by looking ahead and adjusting the controls to make the best speed, fly through every barn and over every windmill, and avoid those pesky geese. Whenever you push the throttle, watch out for the geese.

The best time is achieved by covering the course with the fewest possible corrections to your altitude, so precious seconds can be shaved by flying just above the windmills and just below the openings of the barns.



If you should misjudge and fly **over** a barn, your barn count will remain unchanged, and the course will be extended until you can make up the missed barns and fly through the required number.

Avoiding crashes with barn roofs, barn interiors, weather vanes, windmills and geese will really save time. Better to slow down a little and avoid a crash, than to lose time picking up speed from a dead stop.

JOIN THE ACTIVISION® FLYING ACES

If you beat a time of 33.3 seconds on game 1, 51.0 seconds on game 2, or 54.0 seconds on game 3, you can join our Activision® Flying Aces (and earn a special patch as your reward.)

HOW TO BECOME AN “ACE” AT BARNSTORMING™ BY ACTIVISION®

Tips from Steve Cartwright, designer of Barnstorming.

Steve is the newest member of the Activision design team. He was discovered by David Crane.

"There are two stages involved in mastering this game.

"After playing this game a few times, you'll begin to learn the course. By knowing what is coming up ahead, you can keep your biplane at full speed.

"But, being able to fly through the barns and over the windmills is only the beginning. The real secret is in carefully navigating through the flocks of geese. With practice, it *is* possible to fly the course at full speed with no collisions.

"It has really been a great challenge designing my first game for Activision, and I'd particularly like to thank David Crane for his help in 'getting me off the ground.'"

P.S. Drop me a line. I'd love to hear about your daredevil exploits!

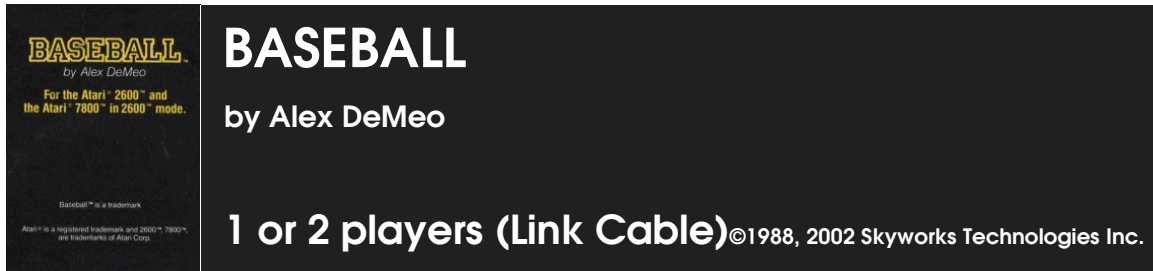

MY BASEBALL STATS

by Alex DeMeo, Designer of Baseball and die hard sports fan

“For over 10 years I've coached and played local league ball – spending most of that time pitching and power hitting. And I loved every inning of it.

“I tried to capture those action-packed feelings in your Baseball video game. In fact, I've designed a game so fun and so real – that you'll want to put on a pair of cleats and hit a few out. So even if you can't physically be at the ball park, you can still feel all the excitement of competitive pro baseball – without ever leaving your room!

“I've spent years designing sports games. I trained long and hard for this moment. And now that it's here – let's not waste another minute. Play ball!”

INSTRUCTIONS

TO BEGIN:

1. Please refer to the official manual of *Activision® Anthology* for Game Boy® Advance to review how to setup and select this game.
2. A two-player game requires the use of a second Game Boy® Advance unit connected with a Link Cable. Refer to the official manual for details on how to set this up.
3. Press the SELECT button to begin a one player game. (At any point during the game, simply press SELECT to start again).

PLAY BALL!

Holding the L button and pressing UP on the D-Pad will bring you to the Pitching/Batting screen to start a new game. Then, you'll have the choice of either playing the computer (one player) or an opponent (two player), which is displayed at the top of the screen. Repeatedly pressing UP on the D-Pad will switch between these two modes. To "Play Ball", press the SELECT button and the game will begin.

THE SERIES...

It's the last game of the World Series. You're in the 9th inning. Bases loaded. One out. And you're up at bat.

What do you do? Swing away? Wait for a walk? Go for the fences? It's all up to you, just like in real pro ball.

Sure, we'll give you the options. And some tips. Like in pitching. Batting and fielding. But, it's your call.

There are 6 full-colour, live action screens – just like the ones you see on TV! The pitching/batting screen, left infield, right infield, leftfield, centerfield and rightfield.

So, start warming up. Step up to the plate. And take your best swing at winning the series!

PITCHING, BATTING

Excitement on the Mound!

PITCHING:

First, decide whether you want the pitch inside or out. Move the D-Pad left or right to position your pitcher on the pitching rubber. Next, use the D-Pad to control the velocity of the pitch. UP for fast. DOWN for slow.

Once you've positioned your pitcher and selected a pitch speed, press the A button to start the wind up and move the D-Pad UP for a fast ball. DOWN for a sinker. LEFT, a screwball. RIGHT, a curveball. Or do not press any direction on the D-Pad for the change-up.

When the pitcher releases the ball, the D-Pad direction pressed will determine what pitch is thrown.

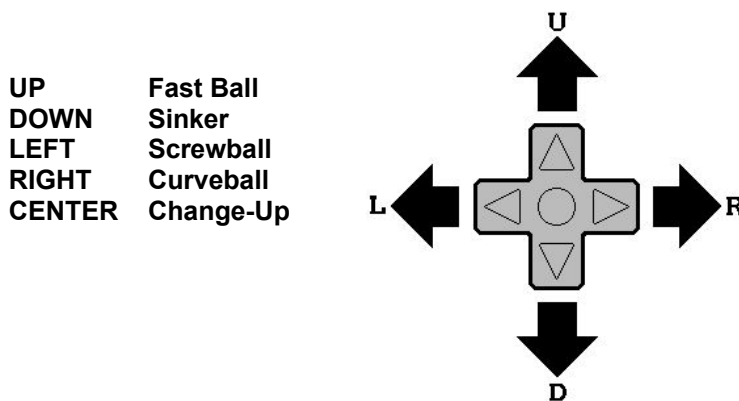

Putting the ball in play

BATTING:

To get the ball rolling – or flying – you first have to connect.

Use the D-Pad to move your player around in the batter's box. You can move the batter up or down to swing high, down the middle, or low. You can also move left or right – for hitting inside and outside pitches.

As you see the pitch coming, you can make split second adjustments – to best handle the pitch thrown.

As the ball approaches the plate, press the A button to swing.

RUNNING, FIELDING

First, 2nd, 3rd and home!

RUNNING:

After you hit the ball, you control the runners. All of the forced runners will advance automatically – if the ball is hit on the ground or bounces before it's caught. Runners who aren't forced, will rely on your coaching.

There are 4 basic controls for running:

- D-Pad LEFT, A button released Advance all runners
- D-Pad RIGHT, A button released Hold all runners
- D-Pad LEFT, A button pressed Advance lead runner
- D-Pad RIGHT, A button pressed Hold lead runner

INFIELD FLY RULE:

If a fly ball is hit to the infield, and there are less than 2 outs, and first base is occupied – the runners will not advance and the batter will be called out.

How to make the plays – and get the outs

FIELDING:

After the ball is hit, you'll see either the left or right infield screen – depending on the flight of the ball. While the infield screens are displayed, with the A button pressed, you can select a fielder based on the following D-Pad directions:

For Left Infield:

- UP 2nd Base
- DOWN Catcher
- RIGHT Pitcher
- LEFT 3rd Base

For Right Infield:

- UP 2nd Base
- DOWN Catcher
- RIGHT 1st Base
- LEFT Pitcher

If it's smacked into the outfield, the left, right or centerfield screen will be displayed.

Once you've guided your fielder to retrieve the ball, with the A button pressed, use the following D-Pad directions to throw:

UP to 2nd Base LEFT to 3rd Base
DOWN to Homeplate RIGHT to 1st Base

MORE FIELDING AND TIPS

The flashing arrows in the baseball diamond at the top of the screen will remind you of D-Pad positioning for making throws. Since the infield is never displayed all at once, the small baseball diamond will inform you of the current positions of the runners.

* A base note – your infield players can only move up and down within the following boundaries:

Short or 2nd baseman
3rd or 1st baseman
Pitcher
Catcher



TIPS FROM THE PROS

- To judge a fly ball, chase the ball's shadow – NOT THE BALL ITSELF! It'll always land to your advantage – trust me!
- Remember to watch the flashing arrows in the small baseball diamond at the top of your screen, when trying to decide which base you want to throw the ball to.
- Of course, official baseball rules apply . . . 3 strikes, you're out, 4 balls, take your base. 3 outs, the inning's over. And so on.

... I hope these tips will give you a better grip on the game – and a great shot at winning the championship.

Now that we've covered all the bases – get your pro ball career off to a flying start. Select an opponent. Press SELECT. And play ball!

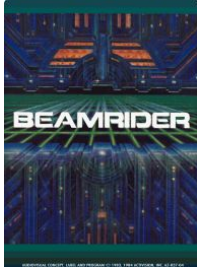

BEAMRIDER™

by Dave Rolfe

1 player

© 1983, 1984 Activision Inc.

The Restrictor Shield, 99 sectors deep, now surrounds the Earth. You are the Beamrider, on a mission to clear the Shield. There you must demolish an onslaught of alien frights as you dodge from beam to beam. Sector after sector, the deluge deepens.....

INITIAL SET-UP

1. Please refer to the official manual of *Activision® Anthology* for Game Boy® Advance to review how to setup and select this game.
2. Hold the L button, and press LEFT on the D-Pad to toggle the level of difficulty: **A**=Advanced, **B**=Basic. At the basic level, you'll start the game at stage 1, and at the advanced level, you'll start at stage 8.
3. Press the SELECT button to reset the game (this can be done at any time) and press any direction on the D-Pad to start the action. Laser lariats are fired by pressing the A button. To fire torpedoes, push UP on the D-Pad.

The control panel at the top of the screen displays your score, the sector number, the number of enemy saucers in the current sector, and up to three torpedoes. Your remaining ships in reserve are displayed at the bottom of the screen, on the left side.

BEAM BEARINGS

Enemy Saucers. There are 15 enemy saucers in each sector. They all must be destroyed before you can go to the next sector. Every time a saucer is hit, the number in the upper left corner of the screen will count down by one.

The Sector Sentinel. When all 15 white enemy saucers have been destroyed in a sector, their Sentinel ship will cruise across the top of the beams. Only a torpedo can destroy it.

Weapons. Laser lariats are only effective against certain invaders (see "Dangerous Encounters"). Torpedoes, however, will destroy the first object they meet on a beam. You are only given 3 torpedoes per sector. Use them sparingly since they are your only weapon against the Sector Sentinel.

Yellow Rejuvenators. Occasionally, yellow rejuvenators will float through the beam matrix. Allow them to land on your deck, as each connection will add a bonus ship to your fleet. If you shoot or torpedo a rejuvenator by mistake, it will turn red from the heated blast. Get out of the way! The wreckage will destroy you on contact.

DANGEROUS ENCOUNTERS

With the first swing of your laser lariat, the white enemy saucers approach. But there's more. As you progress through the Restrictor Shield, a sinister collection of aliens will materialize. A new danger is added with every other sector, up to sector 12:

SECTOR	CRAFT	VULNERABLE
1	White Enemy Saucers	Yes
2	Brown Space Debris	No
4	Yellow Chirper Ships	Yes
6	Green Blocker Ships	No
8	Green Bounce Craft	No
10	Blue Chargers	Yes
12	Orange Trackers	No

Only "vulnerable" objects are affected by laser lariats (saucers and chirpers are destroyed; chargers are deflected). Everything else can only be dodged or, in extreme cases, torpedoed.

SCORING

Points are scored each time an enemy saucer, chirper ship or Sector Sentinel is destroyed. Point values increase as you progress to higher sectors.

Also, if you manage to destroy the Sector Sentinel, you'll receive an additional bonus for each ship in your fleet.



JOIN THE ACTIVISION® "BEAMRIDERS"

Beamriders are a breed all their own. Part warrior, part astronaut and part daredevil. If that sounds like you, and if you've made it to sector 14 with a score of 40,000 points or more, join the club, and you'll receive an emblem that will identify you as an official Beamrider.

HOW TO BE A “BEAMRIDER”

Tips from Dave Rolfe, designer of Beamrider™

Dave Rolfe is a seasoned software designer, with an academic background in engineering and computer science. In his spare time, he can be found bicycling or listening to rock'n roll.

“Greetings from sector 26 and moving! If you want to make it to the outer sectors, pay attention to these tips.

“Maintain precise control by learning to TAP the Control Stick to move your ship a single beam at a time. And stay near the centre beams so you won't get boxed into a corner with nowhere to run.

“Zap the white enemy saucers as early in their approach as possible. And check this out: You can hit them when they're slightly off the beam, before they can drop their missiles.

“When you see a yellow rejuvenator, don't abandon all caution as you move to catch it or you'll likely wreck your ship. If an enemy object is blocking the rejuvenator, you can use a torpedo to blast it out of the way. Then, catch the rejuvenator. But remember, you only have three torpedoes and they're your only weapon against the Sector Sentinel.

“And while we're on the subject, when the Sentinel is about to approach, don't sit on the beam you plan to shoot from. Green Blockers will swarm on to it immediately! Instead, wait on a beam you're not going to shoot from (like the one nearest the Sentinel's first sighting). As soon as the Blockers are `locked' onto that beam, zip over to an unblocked beam and torpedo the ship.

“Last, but not least, take time to notice the enemy attack movements. They generally follow a pattern of motion that allows you to anticipate many of their moves.

“With practice, you'll be in the outer sectors before long. If you get too far out, come down to Earth for a while and drop me a line. Because reading your letters is the next best thing to designing games.”

Beamrider™ for Atari 2600 adapted by Cheshire Engineering (Dave Rolfe and Larry Zwick).

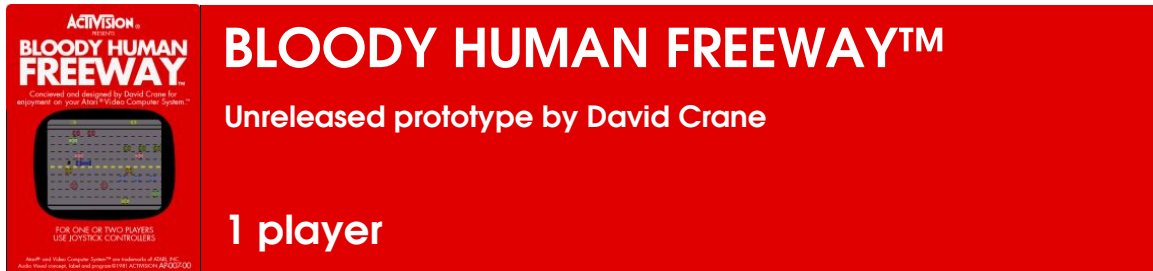

Bloody Human Freeway™ is actually the original version of *Freeway*™, and features people instead of chickens. While this version may not be politically correct, it sure is funny!

This version is actually a little easier than the released version of *Freeway*™ since your guy doesn't bounce off the cars like the chickens do (assuming the left difficulty switch is in the **B** position). Be warned however that you may feel a slight twinge of guilt the first time your man gets turned into a streak of blood, but this goes away with repeated squashings.



PROTOTYPE DIFFERENCES

- The game shows cars on the freeway at start-up instead of them all being lined up on the right side.
- The score and Activision® logo are yellow instead of pink.
- Your character is a little man instead of a chicken.
- When your man gets hit, he turns into a glowing streak of blood instead of being bounced backwards.
- The sounds effects are slightly different (such as the sound of your character being hit).
- Pressing the fire button resets the game.

Note: The instructions presented in the manual of *Freeway*™ on page 73 applies to *Bloody Human Freeway*™, with one exception: ***There is no two-player mode in this prototype version.***

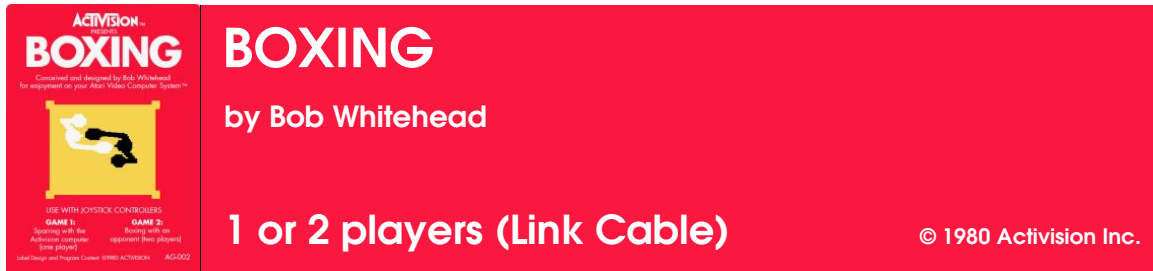

Most people have fun with Activision® video game cartridges as soon as they plug them in and start playing. So go ahead! Use your D-Pad. And when you're ready to learn a few Boxing tricks, read these simple instructions. O.K., shake hands and come out swinging...

BOXING BASICS

1. Please refer to the official manual of *Activision® Anthology* for Game Boy® Advance to review how to setup and select this game.
2. A two-player game requires the use of a second Game Boy® Advance unit connected with a Link Cable. Refer to the official manual for details on how to set this up.
3. Choose the difficulty or handicap setting for each boxer by holding the L button and pressing LEFT (for the white boxer) or RIGHT (for the black boxer) on the D-Pad.
 - A** – Slow down a bit
 - B** – Normal speed
4. Hold the L Button, and press UP on the D-Pad to select your game:
 - Game 1: You against the Activision® computer (he's in black).
 - Game 2: You against another player (also in black).
5. Press the SELECT button to start each 2-minute round.
6. Player 1 uses his D-Pad and A button to control the boxer in white as he plays against the boxer in black (in Game 1 and 2).
7. Player 2 uses the D-Pad and A button on his own Game Boy® Advance unit to control the boxer in black (in Game 2 only).
8. Use the D-Pad to move your boxer around the ring, and press the A button to punch. Hold DOWN on the D-Pad for combination punching.
9. **Scoring (top of screen):**
 - Long jabs – 1 point each
 - Close power punches – 2 points each
 - 100 points is K.O. (it's tough, but you can do it.)
 - Best score at end of match is the winner!

SPECIAL FEATURES OF BOXING BY ACTIVISION®

Scoring Points: When you get near enough to your opponent to throw a punch, press the A button. Each punch moves your opponent **slightly back and away from the punch**. If you move him to the ropes, he can't easily duck the next punch, and you can set up a real scoring barrage. But don't get caught on the ropes yourself!

Watch your distance. If you move in too close, the computer gets tougher; but if you're too far away, you can't land scoring punches.

Give yourself a fighting chance. Put your difficulty setting (L Button + LEFT on D-Pad) to **B** and set the computer's difficulty setting (L Button + RIGHT on D-Pad) to **A**. Then, when you're ready for a really tough bout, take the computer on at **B** and see how well you do.

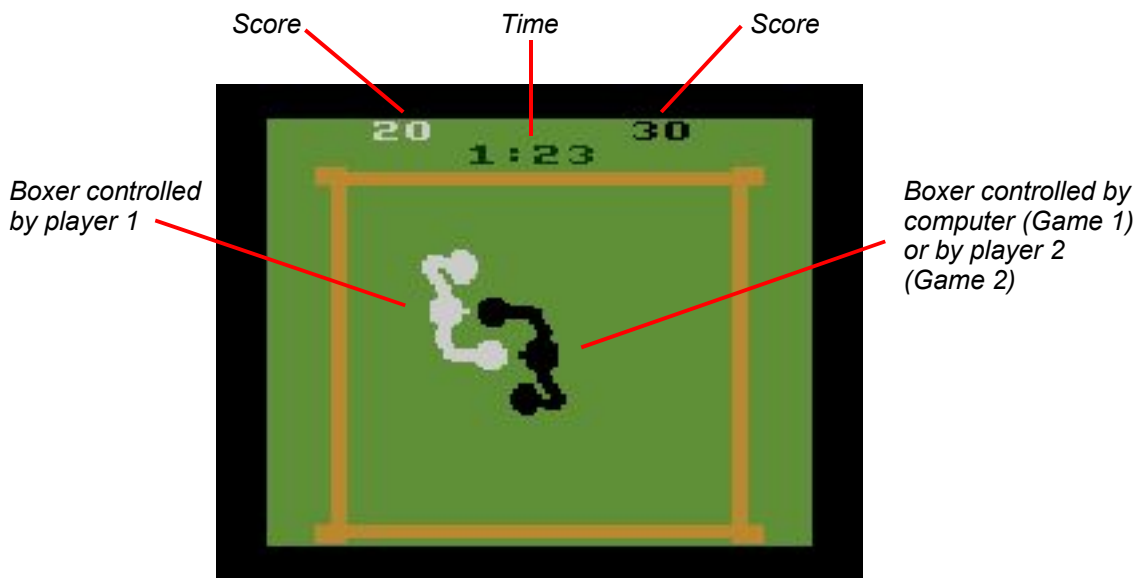

HOW TO BE A CHAMPION AT BOXING BY ACTIVISION®

Tips from Bob Whitehead, designer of Boxing

Bob Whitehead, a senior member of Activision's design team, began designing games for the Atari system in 1977 and worked on numerous well-known game titles. He is busily at work on new games for Activision.

"I wanted Boxing to be fun to play the first time you try it, but I designed some little tricks into the game that will make it more challenging the more you play.

"You'll find that the way to win at Boxing is to hit and dance, hit and dance (just like the pros). Draw off your opponent's jabs by making him punch while you're dancing quickly out of his reach. And watch out! When he gets behind, he gets better. But hang in there if **you** get behind; after the first minute (of each two-minute bout), the computer gets a little tired, and his reactions slow down. Come on strong at the end of the round and you might still catch him. By the way, I shortened the rounds to 2 minutes because... well, you'll see why when you've gone a couple rounds.

"Your best strategy for winning is to jab your opponent until you move him to the ropes, then charge in, mix it up in close, and keep your A button held down. You may be able to repeat a punching combination that builds up your point score fast.

"But – please – be fair to newcomers. Give yourself a handicap when you're showing them Boxing. We don't want you to lose your friends."



You have in your possession the ultimate solitaire bridge game! Bridge by ACTIVISION® deals you hundreds of millions of hands at random, provides a computer partner who bids by rules, and even plays as your opponents after you've established a contract. You can play the same hand over and over again until you're satisfied or keep dealing until you find a hand you want to play. Best of all, you'll never again be without a game with Bridge by ACTIVISION®. Look inside to see how it's done.

A NOTE TO BEGINNING BRIDGE PLAYERS...

Bridge by ACTIVISION® was designed for people who already know how to play the game. It won't teach you the basics – you'll want to read a good instructional book or take some classes for that. But it will give you virtually unlimited opportunities to practice what you learn and sharpen your game – at your own pace.

NOTE: You will find the complete set of rules for this card game in Appendix A of this guide, on page 267.

BRIDGE BASICS

1. Please refer to the official manual of *Activision® Anthology* for Game Boy® Advance to review how to setup and select this game.
2. **Game Select:** Hold the L Button and press UP on the D-Pad to select your game. The game number will appear at the top center of the screen.

If you want to bid and play:

- Game 1: 21 team points or more
- Game 2: 25 team points or more
- Game 3: 29 team points or more

If you want to play without bidding (you set the contract):

- Game 4: 13 team points or more
- Game 5: 21 team points or more
- Game 6: 25 team points or more
- Game 7: 29 team points or more

(Point counts above are based on the standard American point count system popularized by Charles Goren and represent the total combined team points of your hand and your partner's.)

3. **Dealing a hand:** Deal a hand by pressing the SELECT button. Your hand will appear at the bottom of the screen. Every time you press game reset, you will get a new and completely different hand with at least the minimum team point count for that game you have selected.

BIDDING (GAMES 1-3)

1. Select your bid with the D-Pad. It's your bid when you see the bid option flashing on and off in the upper right hand corner of the screen. Press UP on the D-Pad to raise the bid and press DOWN to lower the bid. Bids increase through normal suit rotation (Clubs, Diamonds, Hearts, Spades, No-Trump). Pass ("P", which flashes in red) is always the lowest bid.
2. When the bid you want is flashing on the screen, press the A button to enter the bid. It will appear in the center of the screen above your hand.
3. Your computer partner will then respond. He recognizes most standard opening bids (see below) and uses Stayman and Blackwood conventions, where appropriate, to bid with you to establish a contract. Your opponents do not bid; assume they pass every bid. **Note: Your partner with respond only to the following opening bids: 1 or 2 of any suit, and 1, 2 or 3 No-Trump. If you bid anything else, your partner will pass.** For more details on how your partner bids, see "*How Your Partner Bids in Bridge by ACTIVISION®*", a special companion document found in Appendix A of this guide, on page 275.
4. After your partner bids, his bid will appear in the center of the screen above your bid. Your next highest available bid will begin flashing in the upper right corner of the screen. You should bid again if you are still seeking a contract. The bidding continues until either you or your partner passes; the last bid before passing becomes the contract.
5. If you pass instead of opening the bidding on any hand, the computer will deal a new hand. Your partner will not open.
6. When a contract is established, four things happen:
 - 1) the contract bid is displayed in the upper right corner of the screen;
 - 2) your partner's hand appears (since one of you is now dummy);
 - 3) the upper left corner of the screen shows how many total tricks you need to take to make your contract (in red, with a minus sign); 4) your opponent to the left of declarer leads a card from his hand and play begins.
7. In games 4-7, where there is no bidding, you simply select the contract (or bid) you want to play by using the D-Pad as in steps 1 and 2 above. You may bid on your hand alone or you may check your partner's cards by holding the L button and pressing LEFT on the D-Pad (to set the difficulty switch to **A**) and bid on both hands. Once you select a bid, play starts as described next.

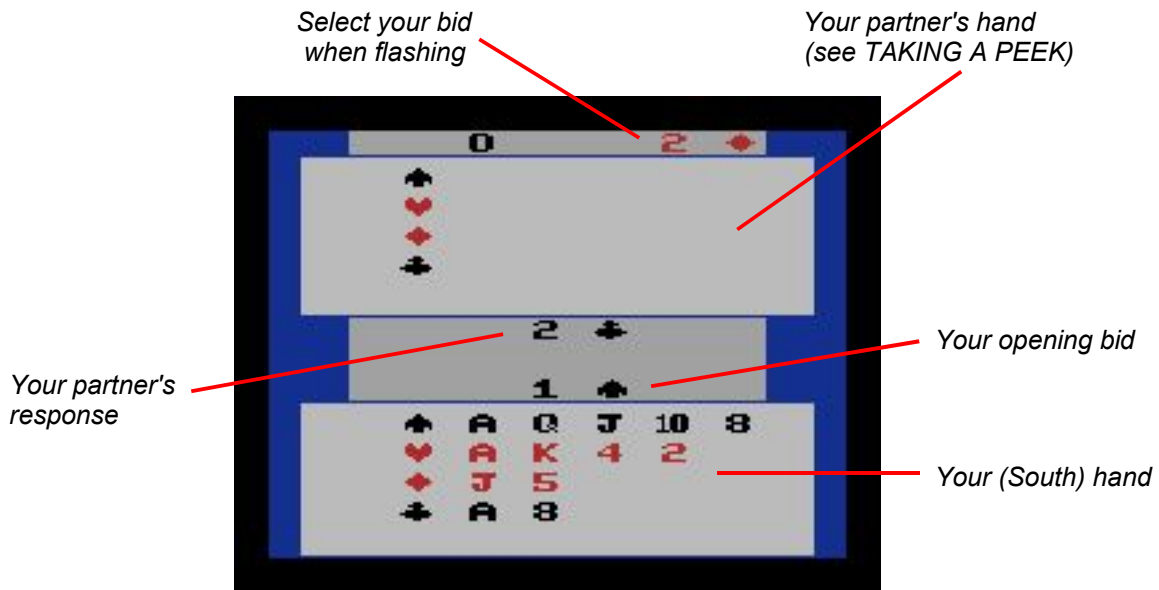

PLAYING (AFTER A CONTRACT IS ESTABLISHED)

1. Playing a hand in Bridge by ACTIVISION® is like playing any game of bridge. After the opening lead, you control the play of both hands on the table, whether North (your partner) or South (you) is dummy. The computer plays East and West in proper order.
2. When it is North's or South's turn to play, one of the cards in that hand will begin flashing. Move the D-Pad left or right until the card you want to play is flashing.
3. When the card you want to play is flashing, press the A button. The card's number and suit will now appear in the middle of the screen.
4. After all four hands have played their cards on a trick, the card that took the trick will start flashing. If your team took the trick, the number of tricks remaining to make your contract will decrease (or your overtricks will increase, if you've already made your bid). After you've reviewed the trick, press the A button again to take the cards off the table.
5. If your team won the trick, a card in the winning hand will begin flashing. You start the next trick by choosing a card to lead from that hand. Continue play as in steps 2 and 3 above. If East or West took the last trick, the computer will lead from the proper hand and the card will appear on the table. Continue play as above until all tricks are played.

After the last trick is played and you push the A button to clear the table, your bid will appear just above your hand, and the number of undertricks (negative, in red) or overtricks (positive, in black) you made will be displayed in the upper left corner of the screen. If a zero (0) appears there, you made your bid exactly. Nicely bid and played! If you overbid or underbid and want to play the hand again, take a look at "Replaying a Hand" on the next page.

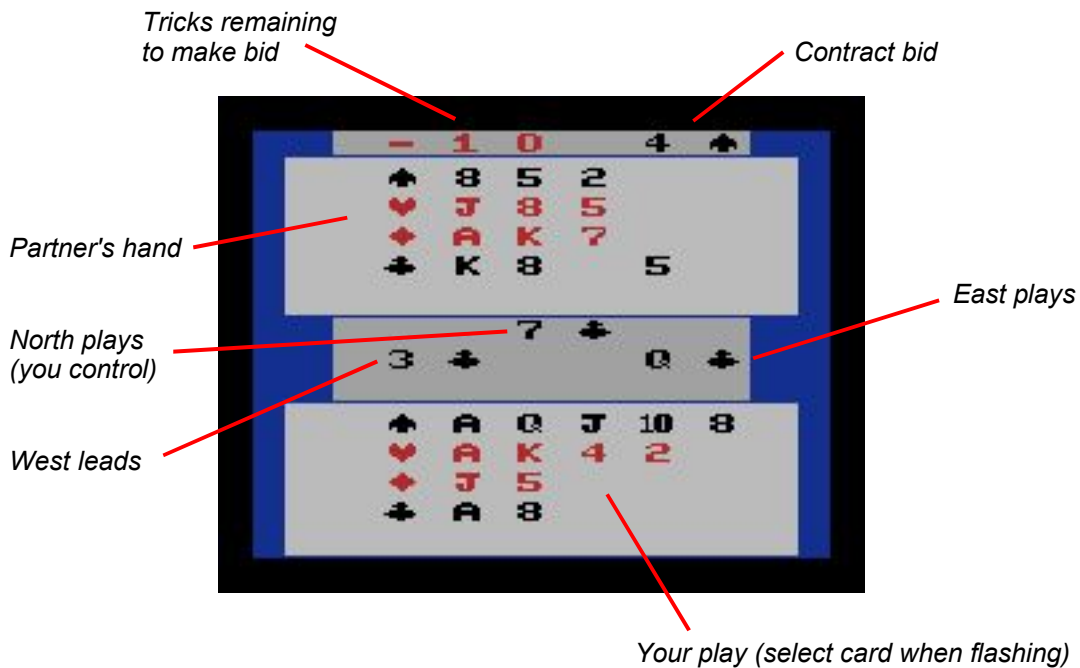

SOME SPECIAL FEATURES OF BRIDGE BY ACTIVISION®

Replaying a hand

You can play any hand over again as many times as you like. Just start bidding again after the last trick is cleared by following the steps outlined in Bidding. If you don't want to replay the hand, press the A button when the "P" is flashing, and the computer will deal a completely new hand.

Starting over

One of the great things about Bridge by ACTIVISION® is that you can start playing over again in the middle of a hand, if you don't like the way the hand is playing. To start over, you must first finish playing a trick, but, instead of simply pressing the A button to clear the trick, press DOWN on the D-Pad and hold it there while pressing the A button. The hand will reset at the beginning, and you can start the bidding over again. You may want to try this a few times to practice the procedure.

Taking a Peek

Use the left difficulty switch (hold the L Button and press LEFT on D-Pad) to determine whether your partner's hand is visible during the bidding:

- A** – Displays both your hand and your partner's.
- B** – Displays your hand only.

Use the right difficulty switch (hold the L Button and press RIGHT on D-Pad) **after you have played a hand** to see what your opponents held. East will show on the top of the screen, West on the bottom. A flashing red "E" will appear beneath the East hand.

A – Displays East and West hands after play is complete.

B – East and West hands are not displayed at any time.

Note: As long as the left difficulty switch is used to show your partner's hand, you cannot deal a new hand by pushing the A button. You must press the SELECT button to reset and deal a new hand.

HOW YOUR ACTIVISION® COMPUTER PARTNER BIDS

A complete description of how your computer partner responds to your bids is discussed in a text titled "*How Your Partner Bids in Bridge by ACTIVISION®*" (which you will find in Appendix A of this guide, on page 275).

HOW BRIDGE BY ACTIVISION® CAN HELP YOU SHARPEN YOUR GAME

Tips from Larry Kaplan, designer of Bridge.

Larry Kaplan has been playing bridge since high school. Like most of us, he frequently has had the experience of not being able to find a fourth, let alone a second or third, to play bridge. He has solved this problem with Bridge by ACTIVISION®. Larry is a senior member of the Activision design team and a veteran video game designer.

"Our game, like bridge with cards, has millions of possible hands. I calculate that our computer can deal over five hundred million different hands. None of us in the design group has yet seen the same hand twice, and we play almost every day.

"I can't give you tips on how to beat the game, because the point isn't to beat it. Its purpose is to let you have fun running through a wide variety of bidding and playing situations, with your choice of minimum partnership point counts, playing and replaying as many hands as you want without having to gather up other players to practice.

"Many people who have tried Bridge by ACTIVISION® say that it can help partners better understand each other's bidding and interpretation of the point count system. Some of you may quarrel with some of my computer playing rules, but I tried to adjust the computer bidding and playing to reflect the way a vast majority of players would react. Bridge is a wonderfully flexible game, and most players develop their own style of bidding and playing. That's part of the fun of it.

"I hope you enjoy our game of Bridge. I'd love to hear from you with your comments. Good luck!

"P.S. I would like to thank a good friend and great bridge player, Jack Verson, for his invaluable assistance on Bridge by ACTIVISION®."

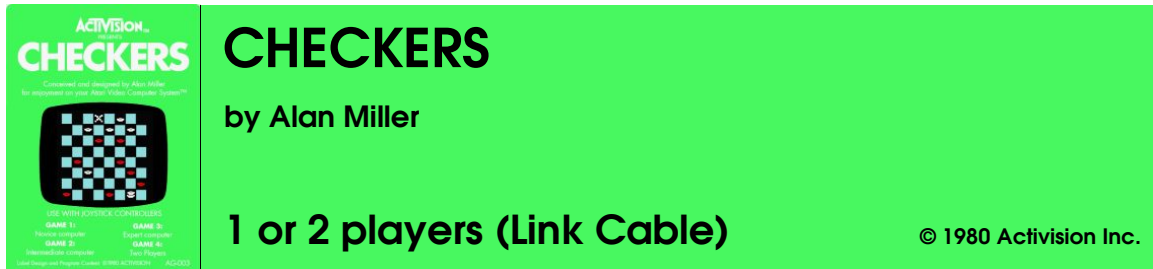

Everybody knows how to play Checkers, right? You're in for a surprise. Checkers is no longer just a one-on-one game. Now, the whole family can gang up and play against the Activision® computer at three levels of challenge. Before you start playing, read these instructions carefully to review the basic rules and learn how to pick up and move your checkers.

CHECKERS BASICS

1. Please refer to the official manual of *Activision® Anthology* for Game Boy® Advance to review how to setup and select this game.
2. A two-player game requires the use of a second Game Boy® Advance unit connected with a Link Cable. Refer to the official manual for details on how to set this up.
3. Choose the position of red and white pieces by holding the L button and pressing RIGHT on the D-Pad. (Pressing LEFT on the D-Pad while holding the L button has no effect on the game.)
4. Hold the L button and press UP on the D-Pad to select your game:
 - Game 1: You against the novice Activision® computer.
 - Game 2: You against the intermediate Activision® computer.
 - Game 3: You against the expert Activision® computer.
 - Game 4: You against another human opponent.
5. To start each new game, press the SELECT button. The color of the flashing X tells you whose turn it is. White always moves first.
6. Player 1 uses the D-Pad and A button to play the pieces on the bottom of the screen (Games 1, 2, 3, 4). Player 2 uses the D-Pad and A button on his own Game Boy® Advance unit to play the pieces at the top of the screen (Game 4 only). Computer plays the pieces at the top of the screen in Games 1, 2 and 3.
7. When it's your turn, use your D-Pad to move the flashing X icon **diagonally** and place it on top of the piece you want to pick up, then press the A button. The checker will now start flashing, showing that you've picked it up. Carry the piece to its new square by moving the D-Pad. Put the piece down by pressing the A button again.* If you try to move a piece to an illegal square, the computer won't let you put your piece down.

* Note: Once you pick up a checker, until you press the A button a second time to release it, you may still put it back where it was or move it to an adjacent legal square. A play is not complete until you press the button to put down a checker in a new spot. But once you've put it down in a new square, it's too late to change your mind. So take your time!

8. Activision®'s computer enforces the rules of Checkers! You **must** take a jump if a jump is available (you can't pick up any other piece). When jumps are available with more than one piece, you can choose any one – but only one. If you make a jump and can jump again with the same piece, you must put down your piece to complete one jump, pick up your piece again, jump again, and put it down again.
9. When it's the computer's move, the game screen goes blank. That means he's thinking. **Don't try adjusting your Game Boy® Advance!** In Game 1, he'll use 5 to 15 seconds per move; in Game 2, up to 30 seconds; at expert (Game 3), 2 to 4 minutes per move. At each level, he's looking further ahead for his next moves.

Average games times?

Game 1 – 15 minutes;

Game 2 – 30 minutes;

Game 3 – 2 hours or longer.

10. To end the game: if each player has only one piece left, call it a stalemate and try a new game. But if a player loses all pieces or cannot make a legal move, then that player loses the game. When the computer loses, he will return the X to the upper right corner without making a move (sulking in the corner).

White X indicates white's move

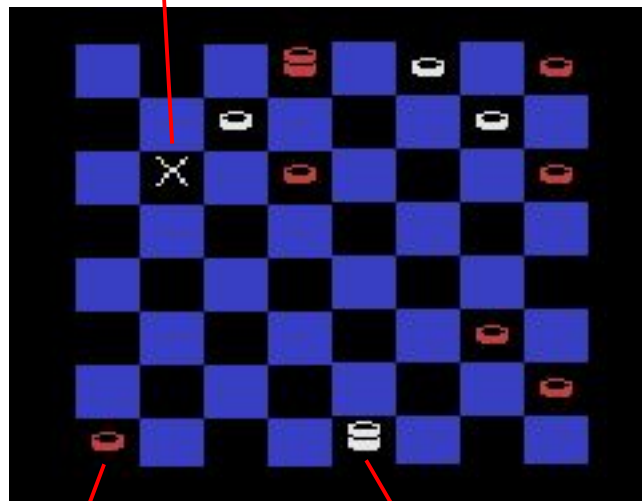

Checker

King

GENERAL RULES OF CHECKERS

1. You can move only one checker per move, one square per move (unless jumping), and you move only along diagonals of the same color toward your opponent's end of the board. You can't move backwards unless you've been "Kinged" (see Rule #4).
2. If you have a chance to jump one of your opponent's pieces, you must jump it. Any other move is illegal. If you are able to jump more than one piece in sequence, you must complete all jumps in a sequence.
3. When you jump an opponent's piece, it is removed from play.
4. A checker becomes a king by reaching the back line of the opponent's side of the board (a king appears as two stacked checkers). Kings move **forward or backward**, one square at a time, along diagonals of the same color.
5. The player who removes all of his opponent's pieces is the Winner. Any player who cannot make a legal move has lost the game.

HOW TO BECOME AN EXPERT AT CHECKERS BY ACTIVISION®

Tips from Alan Miller, designer of Checkers

Alan Miller loves the challenge of playing video games and has become the champion of Checkers and Dragster. He was a senior design engineer at Atari before joining Activision.

"I can't be very much help with tips on how to beat the computer at Checkers. When I discovered any weakness in his play, I worked to improve it. The darn machine frequently beats me.

"The computer will take the time allowed him by the difficulty level and examine all moves available for the next several plays. He will add up total pieces remaining for himself and his opponent and decide which move works best. You'll want to do the same, looking ahead as many moves as you can.

"One weakness the computer still has is that he lacks a killer instinct at the end of a game. Even when he has greater firepower than you do, he seems content to diddle about in the center of the board, not willing to risk an attack, content with a draw. This is your chance to take over the attack – but carefully!

"If you want to become a really good Checkers player, I suggest you go to the library and read up on the game, as I did before designing Checkers by ACTIVISION®. There's a lot of strategy to learn. In many ways, Checkers is more difficult to play well than Chess.

"I want to acknowledge A. L. Samuels, whose pioneering work in the field of computer artificial intelligence has been a source of inspiration to me and to an entire generation of computer programmers and game players."



Your first mission? Don't worry. Everyone gets a little nervous. Just make sure you carefully read this instruction manual first. You'll be dealing with some very sophisticated equipment, and an extremely tricky enemy. So, good luck. The guys on the ground are counting on ya!

CHOPPER COMMAND™ BASICS

The object of the game is to accumulate as many points as possible by knocking out enemy aircraft, while protecting yourself and your truck convoys at the same time.

1. Please refer to the official manual of *Activision® Anthology* for Game Boy® Advance to review how to setup and select this game.
2. A two-player game requires the use of a second Game Boy® Advance unit connected with a Link Cable. Refer to the official manual for details on how to set this up.
3. Holding the L button and pressing LEFT on the D-Pad will allow you to set the continuous firing rate of player 1's helicopter. Likewise, hold the L button and press RIGHT on the D-Pad to set the continuous firing rate of player 2's helicopter. In both cases, setting the firing rate to **B** will cause fast continuous fire from your chopper when you hold down the A button. Set the firing rate to **A** for slower continuous fire.
4. **Game Select.** Hold the L button and press UP on the D-Pad to select a game:

CADET LEVEL	COMMANDER LEVEL
Game 1: one player	Game 3: one player
Game 2: two players	Game 4: two players

5. **To start**, press the SELECT button and allow your helicopter to position itself on the left side of the screen. Action begins as soon as you press any direction on the D-Pad or press the A button.
6. Pressing the A button will fire cannons. Holding the A button down will activate the continuous fire mode. Pressing UP on the D-Pad will cause your helicopter to ascend, pressing DOWN will bring it down. Pressing LEFT or RIGHT on the D-Pad will cause your helicopter to face to the left or to the right. Holding the D-Pad left or right will move your helicopter in that direction.

SPECIAL FEATURES OF CHOPPER COMMAND™ BY ACTIVISION®

1. **The Long Range Scanner** at the bottom of the screen will enable you to detect both approaching truck convoys (friendly) and enemy aircraft well ahead of time. The truck convoys appear as white "blips" on the very bottom of the scanner while enemy aircraft appear as white "blips" above the convoy. Your helicopter gunship is the black dot. You can calculate that the area represented on the long range scanner is roughly 5 miles, while the area portrayed on the large screen is about 1 mile.
2. **There are increasing levels of intensity.** Each level will start with a wave of twelve enemy ships and twelve trucks in your convoy. There are ten waves of enemy attackers, with each wave being faster than the one before. Take care! Enemy aircraft fire multi-warhead missiles which will split in two after being launched from their aircraft. These missiles can destroy both your helicopter and the trucks below, and, since you cannot shoot the missiles down, you must dodge them.
3. **You have an unlimited supply of ammunition,** so go ahead and blanket the sky with your laser cannons.
4. **Scoring.** Each time you shoot down an enemy helicopter, you earn 100 points. For every enemy jet you shoot down, you will be credited with 200 points. Should you wipe out an entire wave of hostile aircraft, you will receive a bonus calculated by multiplying the number of trucks remaining in the convoy times the wave number achieved (one through ten) times 100.
5. **You have helicopter reserves.** You start the game with three choppers in your fleet. For every 10,000 points you score, an extra helicopter will be added to your squadron, up to a maximum of six. The number of extra choppers appears under the score.

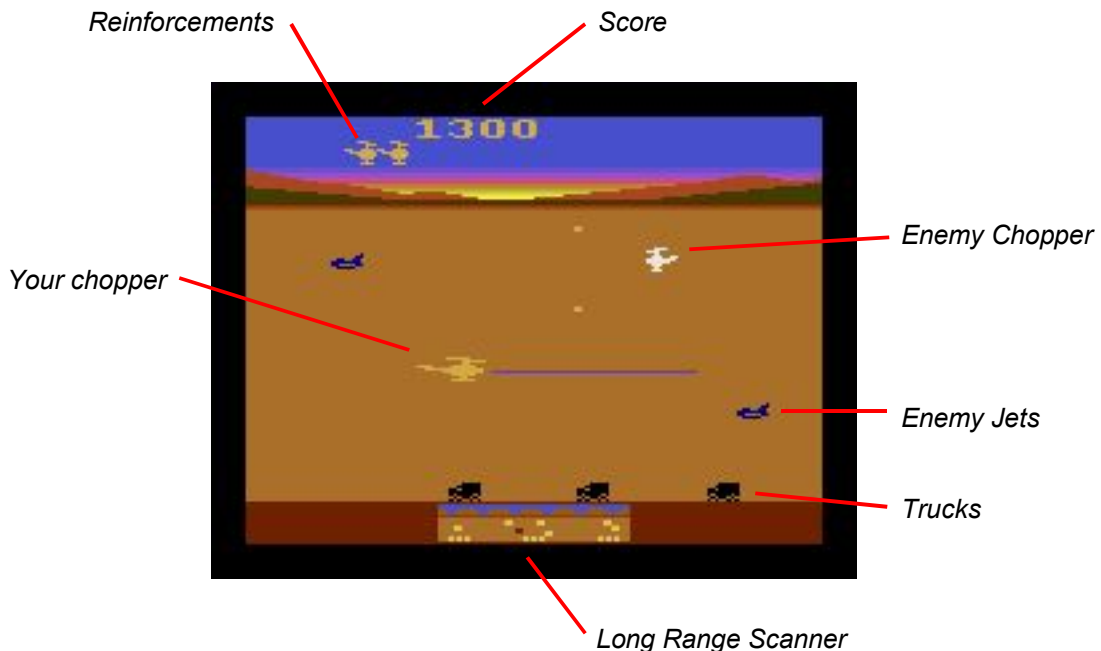

GETTING THE FEEL OF CHOPPER COMMAND™ BY ACTIVISION®

You'll be amazed how responsive your chopper is to the slightest movements of the D-Pad. Pressing UP on the D-Pad will cause your helicopter to climb; pressing DOWN will make your craft descend. Right or left movements will guide your gunship's horizontal motion. After flying in one direction, pushing the D-Pad in the opposite direction will cause an immediate 180° turn. Notice also that your chopper "drifts" slightly after pivoting 180° (this should be helpful in better timing your shots).

Your chopper can hover close to the ground, but be careful not to collide with your convoy. You'll destroy the helicopter and a truck.

Remember, don't be too aggressive at first. Keep your chopper on the left side of the screen facing right, and size up the situation. This will give you time to better recognize enemy tactics. Then, when you feel more confident, you can seek out the enemy and get them before they get to you or your trucks.

The long range scanner is a very useful tool. However, you'll have to keep your eyes on the larger video screen and the scanner at the same time. Watching one and not the other could be dangerous. Don't forget, the long range scanner is for estimating the positions of enemy aircraft and not for lining up shots. You cannot hit the enemy unless you can see them on the larger screen.

JOIN THE ACTIVISION® "COMMANDOS"

If you reach a score of 10,000 points (or more) on the Cadet level, you will be able to join this prestigious organization, and we'll present you with a special "Commandos" emblem.

HOW TO BECOME A "COMMANDO" AT CHOPPER COMMAND™ BY ACTIVISION®

Tips from Bob Whitehead, designer of Chopper Command.

Bob Whitehead is a Senior Designer at Activision. Before creating Chopper Command™, Bob designed Boxing, Skiing and Stampede™ for Activision.

"As you'll soon discover, Chopper Command takes quick reflexes and keen coordination. However, there is a strategic side to the game as well."

"For example, your truck convoys will always travel from the right to the left. And so will the enemy formations. Knowing this, you can position yourself at the left side of the screen and start firing as soon as the enemy aircraft appear. This is important because your helicopter's chances of being hit by a multi-warhead missile increase the closer the enemy aircraft get. The enemy pilots are real kamikazes, too, and they'll collide with you if they can't shoot you down."

"Good luck! I hope you have as much fun playing Chopper Command as I had designing it. God Bless.

P.S. Drop my a line. I'd sure like to hear how our guys are doing at the front."

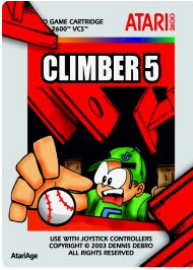

CLIMBER 5

Homebrew game by Dennis Debro

1 player

© 2003 Dennis Debro

PLAY BALL!

What a beautiful day for a baseball game. Sure your friends laugh at you because you're the ball boy but you made the team. The bad thing about being the ball boy is that the games are played with only one baseball. So if a batter hits a homerun the game waits for you to bring the ball back to the park.

You have an important job as ball boy. That's why you have the number 5 on your back to show that you're an important part of the team.

The opposing team comes up to bat. The pitch is thrown and "WHACK!" it's a homerun. The ball flies out of the ball park and lands on a partially constructed building across the street. Sure it's dangerous to climb the construction site and avoiding the moving girders but that's your job as ball boy. The team is counting on you.

PLAYING THE GAME

Please refer to the official manual of *Activision® Anthology* for Game Boy® Advance to review how to setup and select this game.

Hold the L button and press RIGHT on the D-Pad to toggle between NTSC and PAL resolution and colors. ***It is not recommended to play the game in PAL mode on the Game Boy® Advance screen.***

Hold the L button and press UP to select the game variation (See "Game Variations" section below).

Press the SELECT button to restart the game from the selected game variation.

You control the ball boy (Climber 5) with the D-Pad:

- LEFT = Climber 5 moves left
- RIGHT = Climber 5 moves right
- UP = Climber 5 moves up ladders
- DOWN = Climber 5 moves down ladders

The A button is not used for this game.

Hold the L button and press DOWN on the D-Pad to pause the game. Do the same to resume play.

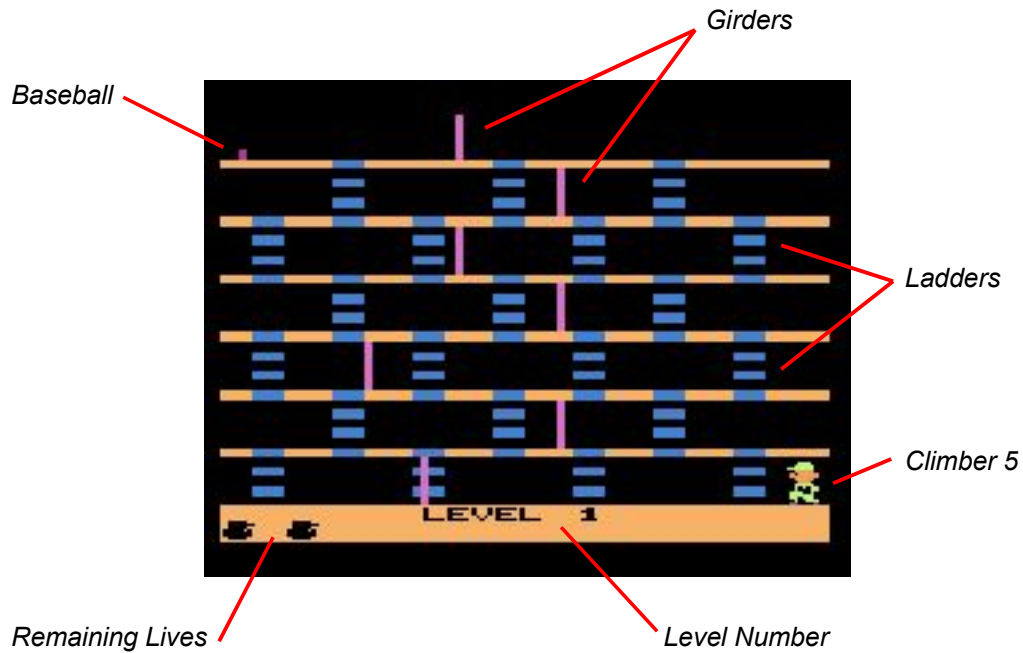

The baseball is located on the top rafter. Use the ladders provided to ascend to the top and retrieve the ball. When the climber touches the ball a success tone will play and the level of difficulty increases.

GAME VARIATIONS

TRAINING: This mode will periodically add a new girder each round. Once all seven girders are in place the game will progress as normal.

NORMAL: A girder is placed on each platform. The climber must dodge these girders to reach the baseball safely.

NOTE: When the game is paused for a period of time (about 10 minutes) the screen will go black. This is put in place to protect your Game Boy® Advance screen. Move the D-Pad in any direction to resume screen output.

ACKNOWLEDGEMENTS

Climber 5 is based on an Atari 8-bit public domain game of the same name. The original game was written by James Rogers and appeared in COMPUTE! magazine (Aug. 1987 – Vol 9, no. 8, Issue 87).

I remember having fun playing this game with my college roommate. The project started in the first quarter of 2002. I was planning to attend the CCAG that year and it was going to be my first classic gaming event. Tim Snider had announced he would release a new hack modelled around Fox's Futurama TV show. He was contacted and asked not to release the game for legal reasons. Being that this was going to be my first classic gaming event, I thought it would be cool to release a game at the event. Plus, since I liked Climber 5 I thought my children would like to play it too. Well, a whole year later we have my original planned game.

This would not have been possible without the permission of Piero Cavina. He gave me permission to use his kernel (used in Oystron and SCSlcide) for Climber 5. Also I received a lot of help from the Stellalist, the Atari 2600 programmers mailing list.

I hope you enjoy this game as much as I enjoyed creating it.



EMPLOYEE HANDBOOK

WAY BACK IN THE TWENTIETH CENTURY, a bunch of Ivy League professors sat around inventing space colonies. They were lauded as visionaries and went on lecture tours. Do you think they thought about traffic jams in space?

Somehow, we don't think they did.

We're the G.T.A. – Galactic Transit Authority. The movers of the daily grind, circa 2075 A.D.

And we're glad you're working for us now.

FOUR PART EMPLOYEE PROCEDURE

1. **Land your Rocket Module.** The Astrobus will instantly separate and begin the commute route.
2. **Pick up commuters** when they appear at surface bus stops. Stay on schedule.
3. **When route is completed,** return to the Rocket Module and reconnect.
4. **Lift-off. Deliver commuters** to Grand Central Space Station.

DRIVER BASICS

- Please refer to the official manual of *Activision® Anthology* for Game Boy® Advance to review how to setup and select this game.
- **Select your game level** (one or two) by holding the L button and pressing UP on the D-Pad. Level two is most challenging, with obstacles being faster and more numerous.
- Holding the L button and pressing either LEFT or RIGHT on the D-Pad has no effect in this game.
- **To start a new game** at any time, press the SELECT button. You can now land your Rocket Module.

- **The Astrobus follows the movements of the D-Pad. To blast meteors and space mines, press the A button. To pick up a commuter, fly over his head and quickly tap DOWN on the D-Pad.**
- **A bonus bus** will be added to your fleet with each increase of 10,000 points.
- **Mandatory retirement** is enforced when you have lost your entire fleet of buses.

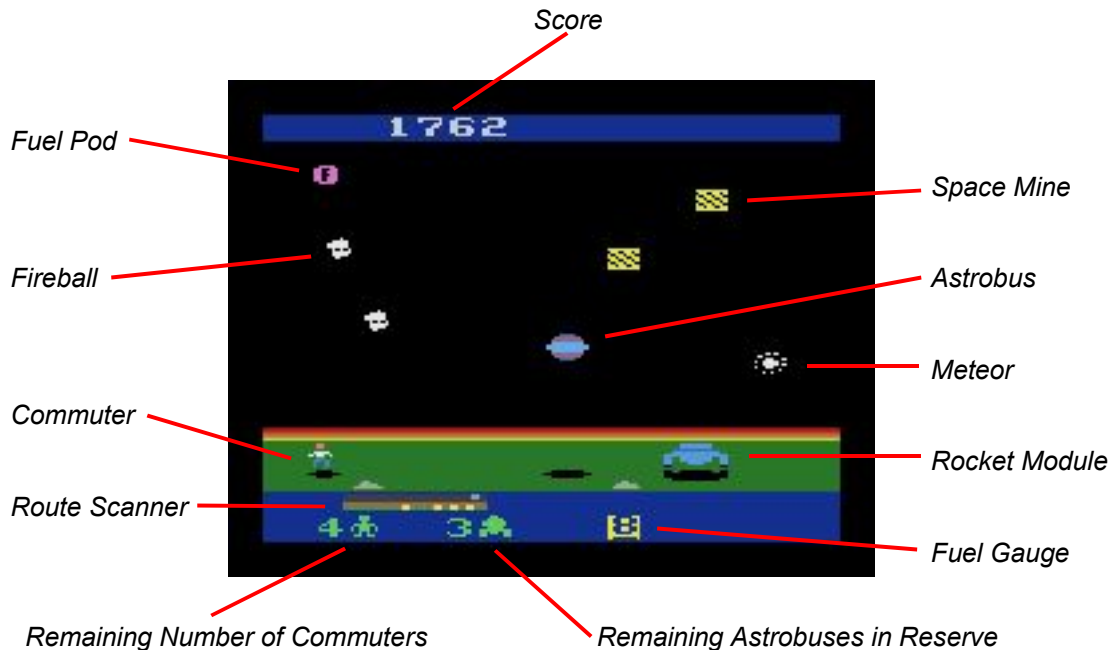

RULES OF THE ROUTE

1. **Before an Astrobus can begin its route,** it must touch down as part of the Rocket Module. For this initial landing, D-Pad action must be delicate and precise. Press UP on the D-Pad to thrust, press DOWN to cut back engines.
2. **The Route Scanner Strip** is at the lower left of your instrument panel. The eight yellow squares represent the commuters waiting along your orbital route. The moving white dot represents your Astrobus. Use the Scanner to check your distance from the Rocket Module and your direction. It also displays the number of commuters remaining and their location.
3. **Commuters won't wait all day!** If you're taking too long to arrive, they'll leave... and you will hear a series of low tones. You must pick up at least one commuter on the route or you will be unable to reconnect with the Module.
4. **When you've completed your route,** a continuous beep will sound. Fly to the 'end of the line' to meet the Rocket Module. When it appears, land the Astrobus directly on top of it.
5. **Watch your fuel level.** When the indicator drops to "3", your engines will sputter. Refuel by flying into a purple fuel pod. Fuel pods are unavailable once you've completed the route.

6. **Meteors, fireballs and space mines** can be dealt with handily by using your A button blaster.
7. **Commuter Delivery.** After Module reconnection, prepare for lift-off. Thrust your engines and head directly up to Grand Central Space Station. You'll hear the commuters pay their fare in the form of points. If all eight commuters have been picked up, delivery points will double!

OVERHEARD AT THE UNION HALL

Tips for Trainees

Joe Muldooner, Local 472, said, "The best way to stay on schedule is to fly close to the surface. You'll lose time if you fly all over the place, trying to shoot everything."

Maude Spinetti, Local 12, added, "I aim to get all eight commuters. That's when those bonus fares really pour in."

Amron Smert, dispatcher, said, "Learn to use the Scanner to choose direction. Remember that it represents an orbit, not a straight line. So sometimes the quickest way to either end of the display is to fly in what appears to be the opposite direction."

Finally, an anonymous voice whispered a secret: "If there are no fuel pods around, one will often appear if you fly to the top of the screen and shoot three times. But even this won't work once all the commuters are gone."



PEST CONTROL HANDBOOK

Approved By Brooklyn Block Association

We're infested! A bug barrage is swarming out of the sewer, chomping away at every building in town. Entire neighborhoods are now crumb piles! Over in Brooklyn, Potsy, the rooftop gardener, is defending his beloved building with his only weapon – potted petunias. Be a good neighbor. Help him take potshots at the insect invaders... Quick! When too many bugs crawl into the windows, they'll start eating you out of house and home!

BASIC BUG BASHING

1. Please refer to the official manual of *Activision® Anthology* for Game Boy® Advance to review how to setup and select this game.
2. A two-player game requires the use of a second Game Boy® Advance unit connected with a Link Cable. Refer to the official manual for details on how to set this up.
3. The **difficulty switches** are not used. (In other words, holding the L button and pressing either LEFT or RIGHT on the D-Pad has no effect in this game.)
4. **Game Select.** Hold the L button and press UP on the D-Pad to select a game:
Game 1 – One player
Game 2 – Two players taking turns
5. **To begin** a new game, press the SELECT button. You'll hear the pitter-patter of tiny bug feet rising up through the sewer. Take a breath and get ready... here they come!!
6. To move Potsy left or right, press LEFT or RIGHT on the D-Pad. To push a pot over the ledge, press the A button when Potsy is standing behind it.
7. **Bugs** come in waves. The first wave is black, then colors progress to blue, red and green. There are twelve bugs in each wave. When you make it through the green wave, the cycle will repeat. However, you'll then be at the next level and all the bugs will move faster.
8. **Six Bonus Bugs** are displayed below the sewer at the beginning of each wave. Whenever a bug slithers into a window, a Bonus Bug will disappear from this display. When six bugs have crawled into the windows, all six Bonus Bugs will be gone and the A button won't release any more flowerpots. Then, one of the crawlers will chew up a layer of your building, and you'll repeat the wave at a slower level.
9. The **game ends** when the creepy crawlers have gobbled up six layers of the building.

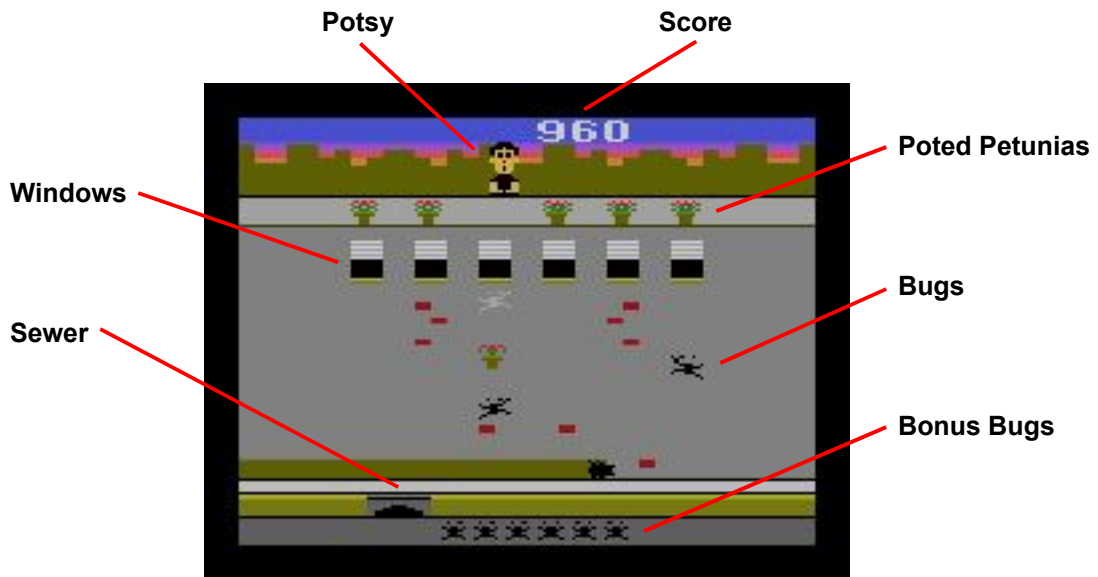

SCORING

LEVEL	COLOR OF BUGS			
	BLACK	BLUE	RED	GREEN
1	10	20	30	40
2	20	40	60	80
3	30	60	90	120
4	40	80	120	160
5	50	100	150	200
6	60	120	180	240
7	70	140	210	280
8	80	160	240	320

Bonus Bugs. 200 points are awarded for each bug print remaining at the end of every wave.

BUGS OF MANY COLORS

The bugs crawl up the wall in four different directions, depending on their color.

Black bugs crawl straight up.

Blue bugs wiggle side to side.

Red bugs crawl diagonally.

Green bugs zig-zag between two windows.

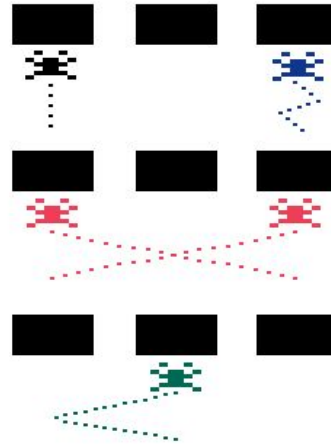

GETTING THE FEEL OF CRACKPOTS

Becoming a seasoned Crackpot doesn't just happen after one day in the big city. You need to stick around for a while and practice. For starters, hang out with Potsy. Check out his speed and style. Develop a sense of timing based on the speed and direction of the bugs and the time it takes for a petunia to fall. This will vastly improve your accuracy at pitching a plant at just the right time.

JOIN THE ACTIVISION® “CRACKPOTS”

If you help Potsy pitch pots at pests for points totaling 75,000 or more, you've been more than a good neighbor. Consider yourself an official Activision® Crackpot: You'll receive the official Crackpot emblem.

THERE'S A BUG IN THE HOUSE!!!

Most people aren't too disturbed by insects crawling in the woods and wilds. Let one appear in the parlor, however, and a frenzy sets in.

Yet, like us, these tiny creatures are nature's handiwork and, as co-inhabitants of planet Earth, perhaps we should all get to know each other.

Roaches are old-timers. Human existence began one million years ago, while roaches have been around for 300 million years! If you're wondering what to serve a roach for dinner, they'll eat most foods, in the pantry or in the garbage. But did you know they also like glue, watercolor paints and stale beer?

Fleas are the high jumpers of the planet. They can leap up to 50 times their height. We'd have to jump up to 300 feet to compete with that!

Clothes moths love wool. But did you know that they eat your sweaters *before* they become moths? The mother moth leaves her eggs on your clothes and rugs and, when they hatch, baby caterpillars emerge. *That's* who does the eating! In their winged state, they are unable to eat.

Spiders are not insects, they're Arachnids. Insects have six legs, spiders have eight. A spider in the house is a friend indeed! If you can tolerate their presence, and don't rub them the wrong way, they will do you no harm. Allow them to spin their gentle webs and rid your house of many insect pests.

HOW TO BECOME THE NEIGHBORHOOD CRACKPOT

Tips from Dan Kitchen, designer of Crackpots™

Dan Kitchen grew up in a family of game designers and computer pros (Garry and Steve are his brother designers). It's no wonder that he was designing games right out of high school – in 1979! In his spare time, he plays folk guitar, tinkers with electronics and jogs.

"Crackpots is a game that requires balance, advanced planning, good aim and the ability to remain calm when things appear hopeless. Follow these tips and you'll soon be a smashing success.

"Play the sidewalk – that is, try to hit the bugs while they're crawling along the sidewalk or when they're just coming out of the sewer. The closer they get to the windows, the less time you'll have to react.

"When you're up in the higher levels, the bugs will crawl too fast for you to get them all. You're better off playing, say, three selected windows in the middle. It's OK if a few crawlers get in on the extreme right or left. You only have to get seven out of twelve bugs to go to the next level.

"Notice that the red bugs end up 2 windows away from where they began their diagonal climb. And, while the building is still pretty high, the green bugs will end up at the window over the spot they started from below. Keep this in mind and you'll soon be dropping the right pot at the right time.

"Then, if you *still* can't stamp out bugs, you can always buy the original, inner-city bug killer – a pair of shoes with pointed toes. Know what I mean? Drop me a line if you do. God bless!"

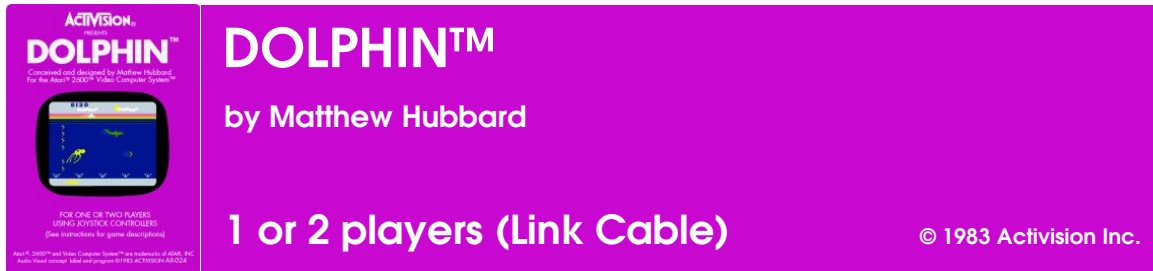

DOLPHIN™ BASICS

Listen! An endangered dolphin is calling you! Only by learning the dolphin's sonic language can you guide her through schools of seahorses, battling a monstrous squid, to gain magic powers from an elusive seagull. Hurry! Lend an ear...

1. Please refer to the official manual of *Activision® Anthology* for Game Boy® Advance to review how to setup and select this game.
2. A two-player game requires the use of a second Game Boy® Advance unit connected with a Link Cable. Refer to the official manual for details on how to set this up.
3. **Difficulty Switches.** Hold the L button and press LEFT on the D-Pad to select the difficulty level of player 1. Set the difficulty level of player 2 by holding the L button and pressing RIGHT on the D-Pad. In both cases, with the difficulty set to **B**, your dolphin will have 4 seconds to touch the squid after intercepting a seagull. With the difficulty set to **A**, she'll only have 2 seconds to do so (see "Seagull" under "How to Decode").
4. **Game variations.** Hold the L button and press UP on the D-Pad to select one of eight game variations. Games 1, 3, 5, and 7 are for one player. Games 2, 4, 6, and 8 are for two players. Level of difficulty rises accordingly, with games 1 and 2 being the easiest. At higher levels, the squid will be smarter and quicker.
5. **To start,** press the SELECT button. The action will begin as soon as you press the A button. *In two-player games, players take turns playing as the dolphin.*
6. Press UP on the D-Pad, and your dolphin will rise. Press DOWN and your dolphin will dive. Press LEFT or RIGHT on the D-Pad and your dolphin will swim in that direction.
7. **Bonus Dolphins.** You start the game with one active dolphin and a school of four on reserve. For every 20,000 points you score, a bonus dolphin will be added to your reserves.

HOW TO DECODE DOLPHIN™ BY ACTIVISION®

You will guide your dolphin through openings in the seahorse schools by listening to sonic tones and catching waves (see "Cues" and "Currents" under "Special Features"). Pay attention to the following:

- **The Seagull.** Periodically, a seagull will fly overhead. You'll know he's coming when the squid changes color. Have your dolphin leap up, touch the seagull and then quickly turn and chase the squid. This is the best way to gain points. Also, the game resets at the next difficulty level putting distance between your dolphin and the squid.
- **The Slip.** Another great way to outsmart the squid is by giving him "the slip". If the squid is right on your tail, wait until he catches a good wave. Then, reverse your dolphin's direction and swim under him immediately. As long as the squid's good wave remains on the screen, he won't be able to reverse and catch you.
- **Scoring.** Points are earned in a variety of ways. Every time your dolphin touches a seagull, or a squid, you score points. The number of points depends on the color of the squid (see "Increasing Difficulty" under "Special Features"). Scoring peaks at 800 per seagull and 8000 per squid.



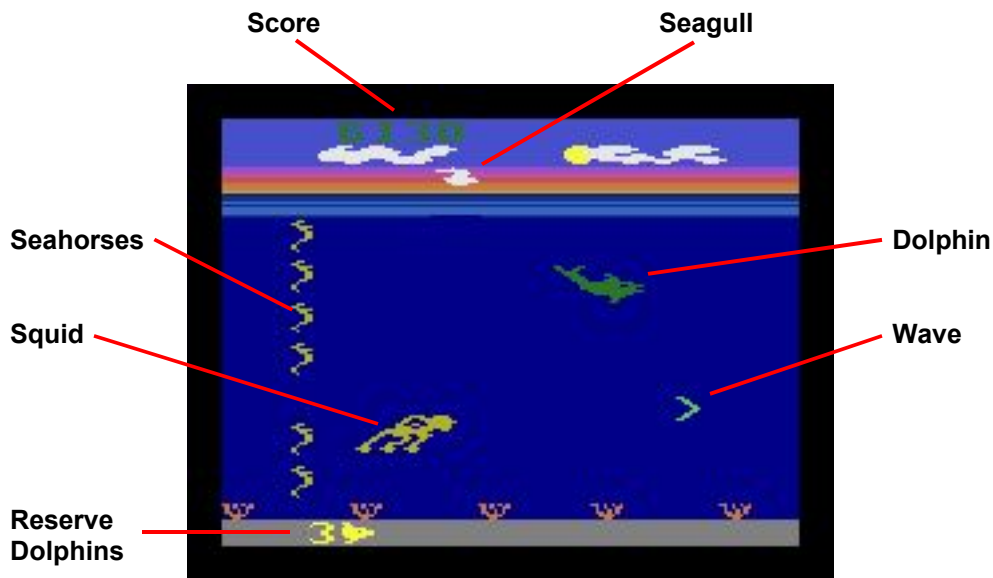



Also, you'll score 100 points each time your dolphin catches a good wave or each time you run the squid into a bad wave. And, when your dolphin swims through the seahorses, you'll score 0 to 50 points, depending on your degree of accuracy in getting her through the opening.



SPECIAL FEATURES OF DOLPHIN™ BY ACTIVISION®

Sonic Cues. The dolphins are communicating with you! The higher the tone, the higher up the opening will be in the upcoming school of seahorses. A lower tone means that the next opening will be lower on your screen. Let your ears guide you! Each time your dolphin doesn't swim perfectly through the opening, she will be slowed down.

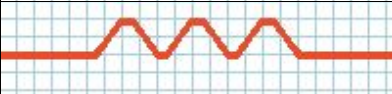
AUDIO CHART FOR DOLPHIN™ BY ACTIVISION®

SOUND		INDICATION
Sonic Echoes		Five different frequencies indicate specific opening in the seahorse schools.
Seagull's Cry		Seagull is flying overhead.
Danger Klaxxon		Dolphin's energy charge is dwindling.
Thuds		Dolphin has bumped into seahorses.
Series of Dings		Dolphin has successfully swum through seahorses.
Low Rumble		Squid has caught a good wave OR Dolphin has caught a bad wave.
High Frequency Beep		Squid has caught a bad wave OR Dolphin has caught a good wave.

Ocean Currents. Catch a good wave! 'Good' waves are arrows moving in the same direction as your dolphin. They'll increase her speed. 'Bad' waves are the arrows moving head-on into your Dolphin. They'll slow her down. Avoid hitting bad waves, but try to lead the squid into them to increase your dolphin's lead.

Increasing Difficulty. The longer you play, the tougher the chase becomes. Each time the squid changes color, he's getting smarter, tracking your dolphin's every move with greater speed and accuracy. So, it gets much tougher to give him "the slip". Meanwhile, the Seagull flies by faster and bad waves move so quickly you'll think you're swimming upstream.

GETTING THE FEEL OF DOLPHIN™ BY ACTIVISION®

As you'll learn, the ocean is full of unique sights and sounds. At first, just keep listening to the dolphin's sonic tones to learn which opening matches each tone. Also, practice catching good waves and leading the squid into bad waves. Don't get frustrated! With practice, you can really develop these necessary skills.

Since dolphins don't fly, you can't hold them in the air when a seagull flies by. So get used to timing her leaps out of the ocean with the speed and position of the seagull. And remember, the squid changes color just before the seagull appears.

JOIN THE ACTIVISION® "FRIENDS OF DOLPHINS" AND THE "SECRET SOCIETY OF DOLPHINS"

Can you reach a score of 80,000 points? If so, you will be eligible to join the ranks of "Friends of Dolphins" and wear their patch.

Then, there is that handful of you who will reach the ultimate. A certain very high score (the amount is secret, but it is under 500,000) will cause the score to be replaced by a secret word. This is the requirement for initiation into the "Secret Society of Dolphins". The ultimate in deep sea dedication and skill, for which you will receive the appropriate patch.

THE DOLPHIN

Tursiops Truncatus

BRAINS: First class – same order of complexity as that of humans.

RESPIRATION: Must surface for air – breathes through blowhole.

HEARING: Ears receive sonic emissions for underwater scanning.

MAXIMUM VELOCITY: 30 knots / 35 mph

SPEECH: Complex click and whistle system with ability to mimic human speech.

SONAR: Computes size, shape, speed and distance of far away objects.

Dolphins have amazing abilities, and have often used them to help people, saving swimmers and boats in distress. Find out more at your library!

HOW TO ENTER THE “SECRET SOCIETY OF DOLPHINS”

Tips from Matthew Hubbard, designer of Dolphin™.

Matthew Hubbard is full of surprises. Besides designing top-notch video games, he's a member of a new wave band! Matt also knows a lot about dolphins, and we're pleased to introduce them in his first work on behalf of Activision®.

"The best tip I can give you is this: 'He who hesitates is lunch.' But, for the record, here are a few more pointers.

"At first, don't completely rely on the 'slip'. Instead, become an expert at decoding sonar. Work with one tone at a time until you can easily predict the exact location of each opening. Notice, too, that there is never an opening at the very bottom or very top of the schools.

"Another thing to notice is that a bad wave often follows each opening. So, after your Dolphin swims through, be ready to make a quick move.

"Dolphins are truly amazing, and I hope my work will inspire you to find out more about these great mammals. If you read any interesting facts, or would like to discuss the game, send me a note. I look forward to hearing from you."



You have in your hand one of the most exciting video games ever designed. **One word of caution:** this game takes a little time to learn because it's so challenging. It's very tricky. So, please read these directions and give yourself some practice time. Then you can aim for the World Record.

DRAGSTER™ BASICS

1. Please refer to the official manual of *Activision® Anthology* for Game Boy® Advance to review how to setup and select this game.
2. A two-player game requires the use of a second Game Boy® Advance unit connected with a Link Cable. Refer to the official manual for details on how to set this up.
3. Difficulty settings have no effect on the game. (In other words, holding the L button and pressing LEFT or RIGHT on the D-Pad produces no effect.)
4. Hold the L button and press UP on the D-Pad to select a game:
 Game 1: Straight-ahead Dragster, one or two players
 Game 2: Steerable Dragster, one or two players.
5. Press the SELECT button or press RIGHT on the D-Pad to start each race. The race starts with a new countdown and both cars in neutral.
6. The D-Pad is both the clutch and gear shift for your Dragster; the A button is your gas pedal. Player 1 uses the top car, while player 2 controls the bottom car with the D-Pad and A button on his own Game Boy® Advance unit.
7. To shift gears, clutch by pressing LEFT on the D-Pad, and shift by releasing the D-Pad.
8. Give your Dragster gas by pressing the A button.
9. Your car starts each race in neutral (N). There are four gear positions – 1, 2, 3, 4 – and you must clutch and shift between each gear. You cannot downshift.
10. When the countdown reaches 0, you can start. If you drop into gear too soon, before the end of the countdown, EARLY will appear on the screen and you have to wait for the next race. You can clutch during the countdown, but you cannot drop into 1st until 0.
11. The object of Dragster is to beat your opponent across the screen, or to race against the clock for best time.

WATCH YOUR TACH

The tachometer (tach) shows how fast your engine is turning over. A dark green line that starts at the left side of your TV screen for each car and turns red at about the middle is your tach. When it turns red, you are in the high power – but danger! – area. You'll find that you get your best speed in each gear by red-lining your tach close to maximum and you'll learn by experience just where that maximum is. But watch out! If you rev your engine too much, it will BLOW. So be careful. Once you blow your engine, the race is over for you (your motor falls out!).

The way to build maximum speed is to quickly clutch, shift and accelerate through all four gears **with maximum power at each gear level.**

Once you start shifting gears, you can't downshift. But if you shift too soon, your engine will lug (work heavily); you will accelerate slowly and lose time. It's tricky and takes practice, but your patience and perseverance will be rewarded with good times.

WORLD CLASS TIMES

In a one-on-one game, you win if you beat the other player. If you want to become an expert drag racer, you'll want to come in under 6.50 seconds. And if you can do better than 6 seconds, you'll be enrolled in our World Class Dragster Club, and receive a special patch.

READY FOR A BIGGER CHALLENGE?

Try Game 2. Not only do you have to clutch and shift your racer quickly through four gears and give it the gas without blowing your engine, you also have to **steer your Dragster** between the grandstands and the center divider. You steer by pressing UP and DOWN on the D-Pad. Any time under 6.20 seconds in Game 2 is sensational.

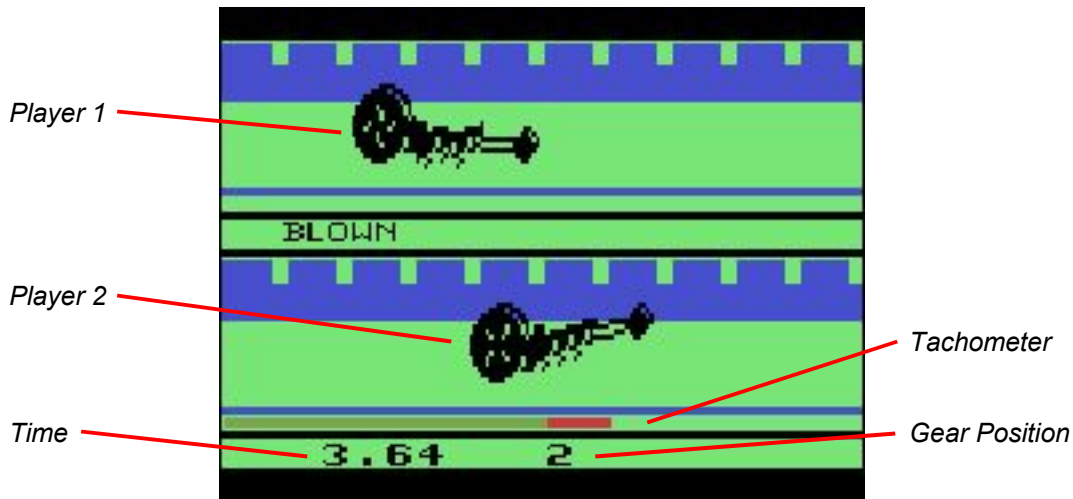

HOW TO BE A WORLD CLASS DRAGSTER™ DRIVER

Tips from David Crane, Designer of Dragster™ by ACTIVISION®

David Crane, a senior member of Activision's design team, started computer game playing as team leader of a college project. David is also the designer of Freeway™, Fishing Derby™, and Laser Blast™ by ACTIVISION®. Dave specializes in games that other designers consider impossible.

"The key to World Class times in Dragster is training your reflexes to clutch and shift quickly, accelerating at maximum power in each gear without blowing your engine. Call it racing shifting, if you like, but it's the only way you'll get your speed down under seven seconds.

"There are a couple of tricks that are not so obvious. For example, put the clutch in during the last numbers of the countdown, hold it in, rev up (careful) and pop the clutch by letting go of the D-Pad the instant the screen reads 0.

"Then you should try to rev your engine to **keep the tach in the red as you go through all four gears** (without blowing your engine). You've got to keep your revs up for speed.

"If you drop out of the red in any gear (and particularly in third or fourth), try tapping the D-Pad quickly to the left a few times ("popping the clutch") to get added acceleration.

"Do a wheelie? Sure, go ahead. When your front wheels come up off the road, you're getting maximum acceleration. But watch out! Push the gas too hard and you'll blow!

"I had great fun doing Dragster. Hope you enjoy it. Write and let me know how you do. So far the World Record is 5.61 seconds. If you break that, it will make news!"



ACTIVISION® NATIONAL ENDURO™ RULES AND REGULATIONS

Strap on your goggles. Sink into your seat. And leave all your fears in the pit. You're about to enter the race of your life. You'll be required to pass lots of cars each day. Through sun and snow and fog and ice, sunrise to sunset – as fast as you can. Welcome to the National Enduro!

ENDURO™ BASICS

1. Please refer to the official manual of *Activision® Anthology* for Game Boy® Advance to review how to setup and select this game.
2. The difficulty switches and game select switch are not used. (In other words, holding the L button and pressing either LEFT, RIGHT or UP will produce no effect.)
3. **To start**, press the SELECT button.
4. Press LEFT or RIGHT on the D-Pad to move your car left or right. The A button is your accelerator. The longer you keep the A button pressed, the faster your car will go, until it reaches top speed. To coast at a constant speed, press the A button until the desired speed is reached. When you release the button, this speed will be maintained. To slow down, release the A button and apply the brakes by pressing DOWN on the D-Pad.
5. **Passing cars.** The number of cars you must pass is posted at the beginning of each day in the lower right corner of your instrument panel (200 on the first day, 300 on subsequent days). Each time you pass a car, this meter counts off by one. When you pass the required number of cars, green flags appear. But keep going. All additional miles are added to your total. You'll move on to the next day when the present day ends. If you don't pass the required number of cars by daybreak, the game ends.



SPECIAL FEATURES OF ENDURO™

Time of day. From dawn till the black of night, you'll be on the road. Pay attention to the lighting and scenery. It represents the time of day, letting you know how much time is remaining. And, use caution at night. You can only see the tail lights of the other cars.

Weather conditions keep changing, so brace yourself. Can you hang in through ice and fog? A white, icy road means your car will be less responsive to your steering. A thick, fog-shrouded screen gives you less time to react, since it will take you longer to see the cars up ahead.

Days and miles. A realistic odometer registers the miles you've covered. Beneath the odometer is the day indicator, which keeps track of the number of days you've been on the Enduro circuit. When the race is over, the mileage on the odometer and the day on the indicator represent your racing results or score.

Increasing difficulty. The race gets tougher with each new day. The other cars travel faster and spread out across the road more and more, making it harder to pass them.

GETTING THE FEEL OF ENDURO RACING

In preparing for a race, every pro driver checks out the course. Be sure to do the same thing. Get to know the timing of the weather and lighting conditions. Learn how your car responds to your touch.

Slow down on the ice and keep your eyes on the patterns of cars in the distance. Drive defensively, since the other cars will not get out of your way. The fog will really test your reflexes. You'll need to slow down and develop a rapid steering response to make up for the limited visibility.

JOIN THE ACTIVISION® “ROADBUSTERS”

Do you have the drive, the stamina, the grit to endure this race for 5 days or more? If so, an on-screen racing trophy will pop up before your very eyes. Now you can join the "Roadbusters", and you will receive the official high performance emblem.

HOW TO BECOME A “ROADBUSTER”

Tips from Larry Miller, designer of Enduro™

Larry Miller is a powerhouse game designer with a PhD in physics. When he isn't designing games, he may be sailing, skiing or playing the piano. His most recent hit was Spider Fighter™.

"The best way to outlast other drivers is to pace yourself. You won't survive long if you stay at maximum speed because you'll keep hitting the other cars. Go only as fast as it takes to pass the required number of cars each day.

"If you can choose between steering into the side of the road or hitting another car, always steer into the roadside. It's just a minor setback, and you won't lose as much time.

"Also, it's always better to go *around* diagonally paired cars than to squeeze between them. But, if you *must* squeeze between them, keep your speed just above theirs and be careful!

"Here's another tip: If you approach a group of cars that are really blocking the road – slow down. Let them disappear back into the distance ahead of you. Then, accelerate. When you meet up with these cars again, they will have probably changed their positions.

"I hope you enjoy the National Enduro as much as I enjoyed designing it. Drop me a card from your next pit stop – I'd love to hear from you. And please, remember to fasten your seatbelts."

THE ROMANCE OF RACING

From the time man learned to drive, he learned to race. And nothing has captured all the challenge and romance of that free-spirited sport like the long distance endurance race.

- **1907.** Peking to Paris. 7,500 miles. The earliest race of its kind. Winner: Italy's Prince Scopione Borghese.
- **1935.** Francois Lecot drives the greatest distance ever covered in one year: 248,548 miles (equivalent to about nine times around the equator)!
- **1953.** The first Safari Rally. 3,874 miles. Through Kenya, Tanzania and Uganda.
- **1977.** London to Sydney. Over 19,329 miles. The longest race of its kind ever held. Cars were ferried by ship!



This is one of the Activision® video games that is fun to play even if you don't know the rules. So go ahead! Use your D-Pad. And when you're ready to find out why some fish bite and some don't, how to tell the whoppers from the lunkers and – especially – how to keep the shark from eating your catch, read these simple instructions. Good luck!

FISHING DERBY™ BASICS

1. Please refer to the official manual of *Activision® Anthology* for Game Boy® Advance to review how to setup and select this game.
2. A two-player game requires the use of a second Game Boy® Advance unit connected with a Link Cable. Refer to the official manual for details on how to set this up.
3. Hold the L button and press LEFT on the D-Pad to set the difficulty or handicap for player 1. Likewise, hold the L button and press RIGHT on the D-Pad to set the difficulty or handicap for the computer or player 2. The effect is the same in both cases:
 - A** – Fish won't bite unless you get the end of your line right under his nose.
 - B** – Fish will bite if you get the end of the line near his mouth.

(Hint: When learning FISHING DERBY™, handicap the computer at the **A** setting, and put **your** handicap setting at **B**.)
4. Hold the L button and press UP on the D-Pad to select the number of players:
 - Game 1 : You against the Activision® computer fisherman.
 - Game 2 : You against another player.
5. Press the SELECT button to start each FISHING DERBY™. First player to land 99 lbs. of those beautiful fish wins.
6. Player 1 uses the D-Pad and A button to play as the fisherman on the left pier (Game 1 and 2).
7. Player 2 uses the D-Pad and A button on his own Game Boy® Advance unit to play as the fisherman on the right pier (Game 2 only).
8. Press LEFT and RIGHT on the D-Pad to move your pole out and back. To lower and raise your line, press UP and DOWN.

9. Scoring (top of screen): There are six rows of fish. From the top down, they count as follows:

- First two rows: 2 pounds each
- Second two rows: 4 pounds each
- Bottom two rows: 6 pounds each

The big ones are down deep! Go for 'em!

HOW TO MAKE 'EM BITE

Drop the very end of your line (that's where the bait is) down to the level you want to fish. Then move the bait to touch the mouth of the fish you want to catch. The difficulty settings determine how close the bait has to be before he bites. See Instruction #6 above.

GOT ONE HOOKED? If you don't do anything after hooking a fish, he will swim slowly up toward the surface (and the shark might gobble him up). If you want to reel him in fast, press the A button. Be quick, though. When both players have hooked a fish, only one can reel up at a time (the first one hooked). The other fish will swim up slowly until the first fish has either been caught or eaten by the shark.

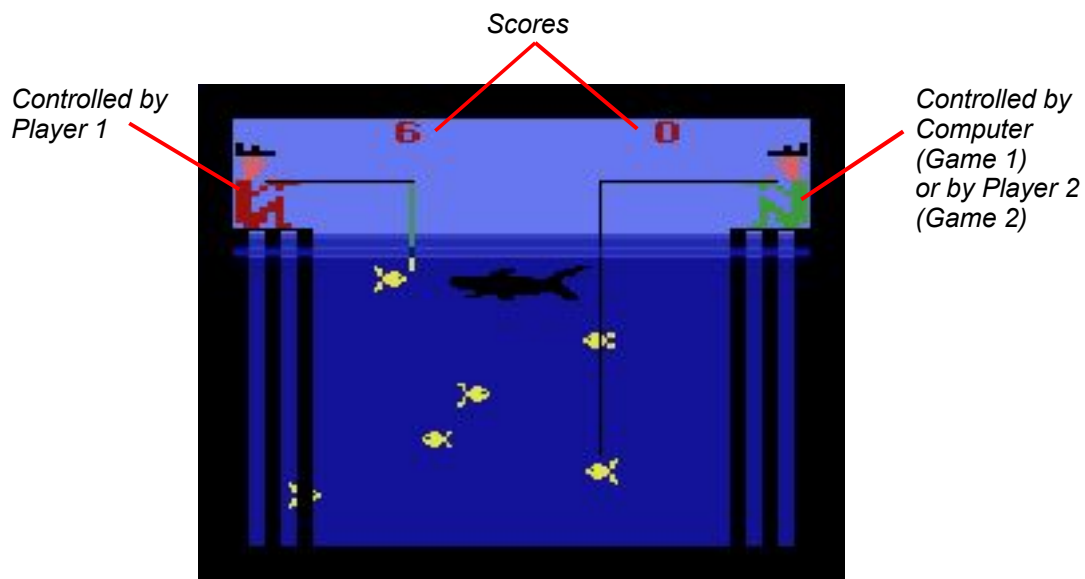

HOW TO BE A CHAMPION FISHING DERBY™ ANGLER

Tips from David Crane, designer of FISHING DERBY

David Crane, formerly a senior game designer at Atari, also designed Dragster™ for Activision. He believes in taking on game assignments that everyone else says are impossible – and always gets them done.

"The most important thing I can tell you is to WATCH OUT FOR THE SHARK! I've made him quick and wily and unpredictable. If your fish touches the shark anywhere, he'll turn in a flash and snap it up. So try to keep your fish away from him while you're reeling in.

"Once you've hooked your fish, you'll want to play him back and forth until the shark moves out of the way, then push the A button and land him **quickly**. You can reel in more or less slowly by pressing or releasing the A button and you can move your line back and forth with your D-Pad.

"Since the big fish are in the fifth and sixth rows, go deep. Start with the fifth row if you're the player on the left. You will have a little advantage there, because you can reach the fifth row first. The player on the right should go to the sixth row to catch his big ones.

"Also, watch to see which fish start from your opponent's side and which start from your side. As fish are caught, they are replaced on the side they started from. It's better for you to catch fish that start under your pier, because you can usually go right back for another one.

"FISHING DERBY™ is a game designed to be fun for everyone in the family. Now you won't have to get rained on or sunburned when you go fishing. I'd like to hear how you like it."



If you think driving on a busy freeway is intense...wait 'till you try to cross it on foot! In Freeway™ by ACTIVISION®, your challenge is to guide a chicken across ten lanes of the most perilous freeway traffic imaginable. Be careful, because those speeding cars and trucks don't brake for animals! So, before you start the chicken across the road, take a minute to read these instructions. You'll find out how to score points by leading your fearless fowl to safety without getting his feathers ruffled by a "semi".

FREEWAY™ BASICS

1. Please refer to the official manual of *Activision® Anthology* for Game Boy® Advance to review how to setup and select this game.
2. A two-player game requires the use of a second Game Boy® Advance unit connected with a Link Cable. Refer to the official manual for details on how to set this up.
3. **Difficulty Settings.** Hold the L button and press LEFT on the D-Pad to set the difficulty or handicap for player 1. Likewise, hold the L button and press RIGHT on the D-Pad to set the difficulty or handicap for player 2. The effect is the same in both cases:
 - A** – Your chicken will return to the curb (the beginning) after being struck by a vehicle.
 - B** – Your chicken is knocked back one lane when struck by a vehicle.Start with the difficulty settings in the **B** position; **A** is for more advanced players.
4. **Game Select.** Hold the L button and press UP on the D-Pad to select your game. In all games, there are ten lanes of traffic, five in each direction.
 - Game 1: Lake Shore Drive, Chicago, 3 A.M.
 - Game 2: Interstate 5, Seattle, 6 A.M.
 - Game 3: Santa Monica Freeway, Los Angeles, 10 A.M.
 - Game 4: Bayshore Freeway, San Francisco, Midnight
 - Game 5: John Lodge Expressway, Detroit, 9 P.M.
 - Game 6: The Beltway, Washington D.C., 6 P.M.
 - Game 7: LBJ Freeway, Dallas, 5 P.M.
 - Game 8: Long Island Expressway, New York City, 3 A.M.
 - (See descriptions under "Special Features".)
5. **To begin play**, press the SELECT button. One or two players may play in any game.

6. Player 1 controls the chicken on the left, while player 2 controls the chicken on the right with the D-Pad of his own Game Boy® Advance unit. Pressing UP on the D-Pad moves your chicken ahead (up). Pressing DOWN moves your chicken back (down). Your chicken can move forward and backward only, not side-to-side. The A button has no effect.
7. **Scoring/Timing.** Each time you guide your chicken successfully across the freeway, you are awarded one point. The score for each player is indicated at the top of the screen, directly above each player's chicken. There are two minutes and sixteen seconds in each game. When the score begins to flash, eight seconds of playing time remain. At the end of each game, the traffic comes to a stop and the final score is shown. Whoever scores the most points is a winner.

SPECIAL FEATURES OF FREEWAY™ BY ACTIVISION®

When the SELECT button is pressed, the traffic in the game you've selected begins to move. This motion is accompanied by sounds associated with a typical freeway: the drone of auto and truck engines, the honks from the horns of the vehicles. Each game has its own combination of these sounds.

Should your chicken get hit, he'll chirp and be knocked back either one lane or all the way back to the beginning (depending on your difficulty setting). He always gets up, though, and is ready to try again.

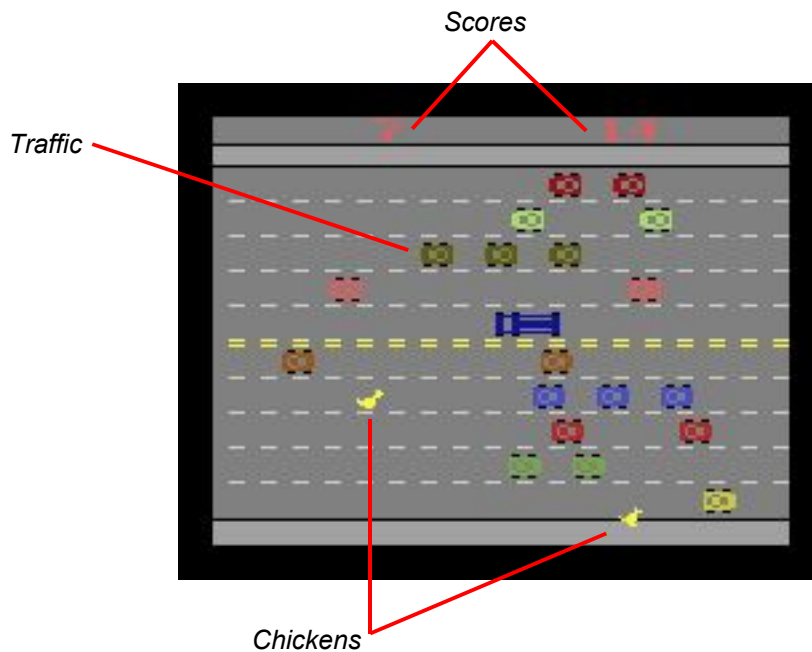

GAMES

Each game offers a different challenge. The type, speed and frequency of traffic all vary, depending on the game.

GAME ONE: LAKE SHORE DRIVE, CHICAGO, 3 A.M.

Automobiles only. Traffic is thin. Speeds are relatively slow. Autos move slowest in lanes closest to curbs, then faster with each lane closer to center of highway.

GAME TWO: INTERSTATE 5, SEATTLE, 6 A.M.

Upper lane closest to center of freeway has trucks; all others have autos. Traffic is thicker and moves faster than in Game One. Speeds of autos increase in the same order as they did in Game One.

GAME THREE: SANTA MONICA FREEWAY, LOS ANGELES, 10 A.M.

Trucks are now in both center lanes. These trucks are the fastest moving vehicles, and they move faster than the fastest moving vehicles in Games One and Two. Traffic is thicker in the two lanes closest to the curbs.

GAME FOUR: BAYSHORE FREEWAY, SAN FRANCISCO, MIDNIGHT

There are trucks in all lanes. The trucks in the lanes closest to center, as well as those closest to the curbs, move at the same speed as the trucks in Game Three. The trucks in lanes 2 and 4 move at half the speed of those in lanes 1 and 5. The trucks in lane 3 are the slowest, and move at half the speed of those in lanes 2 and 4. (Lane at bottom of screen is lane 1; lane at top is lane 10.)

GAMES FIVE THROUGH EIGHT

Similar to Games One through Four in the amount of traffic for each game. But, take care, because the speeds of the vehicles are increased and decreased at random throughout each of these games – without regard to lane. You'll really have to be on your toes, because you can never tell when the speed of any particular traffic will change.

GETTING THE FEEL OF FREEWAY™ BY ACTIVISION®

The objective in Freeway™ by ACTIVISION® is to score as many points as you can by guiding your chicken across the ten lanes of traffic as many times as possible in two minutes and sixteen seconds.

For beginners, try Game One (Lake Shore Drive) with the difficulty set to **B**. Get the feel of how your chicken responds to your D-Pad. Since the traffic flow in Game One is relatively light, you have ample time to react to oncoming vehicles. You want to guide your chicken across the freeway as quickly as possible, but you don't want to put him where he can't avoid an oncoming vehicle. You will need to be aware of traffic not only in the lane closest to your chicken, but also in the lanes on either side.

After you get the feel of Game One, try your hand at some of the tougher highways. And, when you're really feeling bold, put your difficulty setting up to **A** and **watch out!**

Freeway™ by ACTIVISION® is a game of anticipation and timing. After awhile, you'll learn to judge traffic flow and make the right move at the right time. Sometimes that means bravely forging ahead. And, at other times, that will mean sitting back and waiting for just the right opening.

JOIN THE ACTIVISION® "SAVE THE CHICKEN FOUNDATION"

Activision wants to recognize your traffic dodging achievements. So, if you're successful in guiding your chicken through traffic at least 20 times in either Game Three or Game Seven, you can become an official member of the Activision "Save the Chicken Foundation." We'll enroll you and give you a special membership emblem.

HOW TO BECOME AN ACE "CHICKEN CROSSER" IN FREEWAY™ BY ACTIVISION®

Tips from David Crane, designer of Freeway™

David Crane is also the designer of Dragster™, Fishing Derby™ and Laser Blast™ by Activision®. He consistently comes up with highly unusual, imaginative and challenging games.

"As unusual as Freeway is, you still will have to employ some tried and true gaming skills to do well at it. For instance, you must become familiar with the different traffic patterns in order to anticipate and make the right moves. This is especially difficult in Games Five through Eight, where traffic speeds can change instantly.

"You'll notice that clusters of vehicles in each lane travel at generally the same distance apart, at the same speed. If a cluster happens to be in a fast lane, you'll have to plan in advance how you're going to get through without being hit.

"Succeeding at Freeway will depend on your ability to develop quick reflexes to avoid the traffic and "hit the hole" at just the right time. Have fun and watch the traffic!

"Drop me a line. I'd like to hear about your exploits."

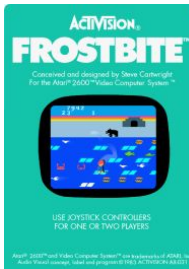

FROSTBITE

by Steve Cartwright

1 or 2 players (Link Cable)

© 1983 Activision Inc.

FROSTBITE BAILEY™'S ARCTIC ARCHITECT'S HANDBOOK

The object of the game is to help Frostbite Bailey™ build igloos by jumping on floating blocks of ice. Be careful to avoid these deadly hazards: clams, snowgeese, Alaskan king crab, grizzly polar bears, and the rapidly dropping temperature.

FROSTBITE™ BASICS

1. Please refer to the official manual of *Activision® Anthology* for Game Boy® Advance to review how to setup and select this game.
2. A two-player game requires the use of a second Game Boy® Advance unit connected with a Link Cable. Refer to the official manual for details on how to set this up.
3. **The difficulty switches are not used.** In other words, holding the L button and pressing LEFT or RIGHT produces no effect.
4. **Game Select.** Hold the L button and press UP on the D-Pad to select a game:

Game 1 – Regular

Game 2 – Regular, two players

Game 3 – Advanced

Game 4 – Advanced, two players

Regular games start at level 1. Advanced games start at level 5. *In two-player games, players take turns playing as Frostbite Bailey™.*

5. **To begin a new game,** press the SELECT button. The ice will start to move and Frostbite can start jumping.
6. To move Frostbite Bailey left or right, press LEFT or RIGHT on the D-Pad. He'll move up when you press UP, and move down when you press DOWN. To reverse the direction of the ice floe you are standing on, press the A button. But remember, each time you do, your igloo will lose a block, unless it is completely built.
7. **Reserves.** You begin the game with one active Frostbite Bailey™ and three on reserve. With each increase of 5,000 points, a bonus Frostbite is added to your reserves (up to a maximum of nine).
8. **Frostbite gets lost** each time he falls into the Arctic Sea, gets chased away by a Polar Grizzly, or gets caught outside when the temperature drops to zero.
9. **The game ends** when your reserves have been exhausted and Frostbite is 'retired' from the construction business.

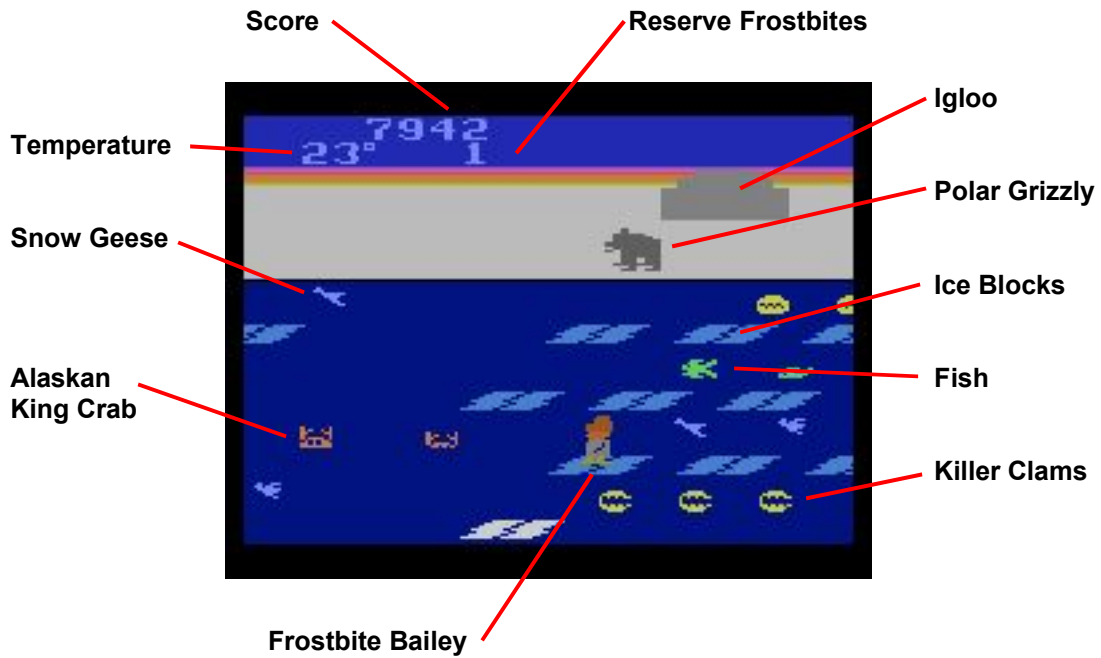

IGLOO CONSTRUCTION

Building Codes. Each time Frostbite Bailey™ jumps onto a white ice floe, a "block" is added to the igloo. Once jumped upon, the white ice turns blue. It can still be jumped on, but it won't add points to your score or blocks to your igloo. When all four rows are blue, they turn white again. The igloo is complete when the door appears. Frostbite may then jump into it.

Work Hazards. Avoid contact with Alaskan King Crabs, snow geese, and killer clams, as they will push Frostbite Bailey into the fatal Arctic Sea. The Polar Grizzlies come out of hibernation at level 4 and, upon contact, will chase Frostbite right off-screen.

No Overtime Allowed. Frostbite always starts working when it's 45° outside. You'll notice this steadily falling temperature at the upper left corner of the screen. Frostbite must build and enter the igloo before the temperature drops to 0°, or else he'll turn into blue ice!

SPECIAL FEATURES OF FROSTBITE™

Fresh Fish swim by regularly. They are Frostbite Bailey™'s only food, and, as such, are also additives to your score. Catch 'em if you can.

Night and Day. Frostbite works the day shift and the night shift. He must build four igloos per shift.

A Magic Fish will appear near your score when you've racked up a certain high number of points. Watch for it!

SCORING

Level	Points per ice block	Points for entering igloo
1	10	160
2	20	320
3	30	480
4	40	640
5	50	800
6	60	960
7	70	1120
8	80	1280
9	90	1440

Scoring remains constant after the ninth level.

- Fish are worth 200 points each.
- Also, each degree remaining when Frostbite Bailey™ enters his igloo will add points to your score as follows:

$$10 \times \text{Degree} \times \text{Level number}$$

JOIN THE "ARCTIC ARCHITECTS"

Getting into any builder's association requires paying your dues. Score 40,000 points or more, and we'll figure you paid yours. If you find the magic fish, we'll be really impressed, and we'll give you the official Arctic Architects emblem.

LIFE AT THE TOP OF THE WORLD

The Arctic probably ranks as the area least chosen by homebuyers, and most of us know little, if anything, about this amazing land. Yet, the Arctic has been home to some of the happiest and healthiest members of humankind for thousands of years – the Eskimos!

Traditional Eskimos believe that nature's gifts belong to everyone. There is no private property except for tools and clothes. Everything else is shared – not only with community members, but with any stranger that travels by!

It is only while traveling that Eskimos live in their famous snow houses. All houses are called "igloos" whether they are made of wood, fur, mud, or snow. The snow variety can be built in about one hour. Here's how:

A knife with a long, wide blade is used to cut snow into blocks measuring 36" x 18" x 6". These are piled in a continuous spiral.

The entrance is a tunnel under the snow or, when the ground is frozen, a long hall, above-ground. This keeps out the cold wind, and keeps the warm air inside. A hole is made in the roof for ventilation.

There are fascinating things to learn from our Arctic sisters and brothers. Find out more at your library.

HOW TO BECOME AN ARCTIC ARCHITECT

Tips from Steve Cartwright, designer of Frostbite™

Steve Cartwright is an Activision senior designer. His prolific talents have already brought you Barnstorming™, Megamania™, Seaquest™, and Plaque Attack™. Aside from video games, Steve enjoys motorcycle touring and photography.

"Here are my favorite tips for high scoring:

"Learn to use the A button sparingly. The best time to use it is to 'fake out' the bear by drawing him to the middle of the screen and quickly changing direction.

"Don't be greedy with the fish. Get them if they come by. However, going out of your way often uses too much time.

"Another thing: You can move Frostbite Bailey in mid-air and, at the higher levels, you can really hook him around. Check out just how far he'll go.

"Notice that hazards only get you when both feet are planted. Therefore, it's possible to jump 'around' hazards since they can't hurt you in mid-air.

"Now here's a secret tip I've decided to share: If you jump up onto the extreme left of the shore, the bear can't get you. It's Frostbite's emergency hide-out.

"Now that you know the inside scoop, I'm expecting some really high scores. But don't stay on the ice too long: You can't write when your hands are cold. And, at the very least, I'm expecting a postcard."

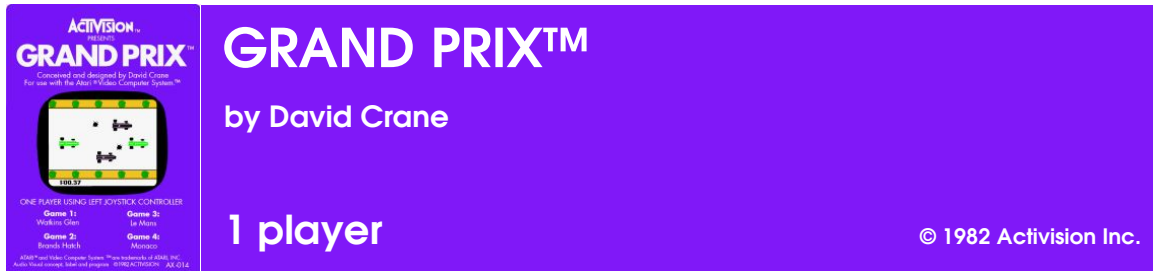

You're about to enter the race of your life. Nothing stands between you and victory except the clock, the road and the other drivers out to beat you to the finish line. So take a little time with these instructions, and you may emerge as the Grand Prix world record holder!

GRAND PRIX™ BASICS

1. Please refer to the official manual of *Activision® Anthology* for Game Boy® Advance to review how to setup and select this game.
2. Difficulty Switches have no effect. In other words, holding the L button and pressing LEFT or RIGHT on the D-Pad produces no effect.
3. **Game Select.** Hold the L button and press UP on the D-Pad to select a game:
 - Game 1: Watkins Glen
 - Game 2: Brands Hatch (1 Bridge)
 - Game 3: Le Mans (2 Bridges)
 - Game 4: Monaco (3 Bridges)
4. **To begin play.** Press the SELECT button. Your racer will be in position at the starting line. Press the A button, and the race begins!
5. **Gaining speed.** The A button is your accelerator. Press it to accelerate your racer. Shifting is automatic. The longer you keep the A button pressed, the faster your racer will go until it reaches top speed.
6. **Slowing Down.** Releasing the A button will slow down your racer. To apply the brakes, press LEFT on the D-Pad.
7. **Steering.** Pressing UP on the D-Pad moves your racer toward the top of the track; pressing DOWN moves it towards the bottom.
8. **Object of the game.** To complete a race circuit in the shortest possible time.

SPECIAL FEATURES OF GRAND PRIX™ BY ACTIVISION®

Oil Slicks. Just a little extra test of your reflexes. They won't slow you down, but they may send you sliding off into another car. Slicks are best avoided, but, when you need to pick up time, and there's no other car next to you, you can risk steering a straight course through them.

Crashes. They will happen, but should be avoided if at all possible. Crashes with other cars reduce you to a speed slower than that of the car you hit. To really cut your speed and avoid a crash, release the A button while pressing LEFT on the D-Pad to apply your brakes.

Steering Response. As in a real racing car, your steering becomes more responsive the faster you go; expect your car to react faster when you move the D-Pad up or down at high speeds. Your speed is slightly reduced every time you steer; to achieve the fastest time, keep steering adjustments to a minimum.

Bridges. On the Brands Hatch, Le Mans and Monaco courses, after each mile of the race, you'll cross a bridge over blue water. As your car enters the bridge, your elapsed time to the bridge is displayed and held. Normal time display is resumed as your race car leaves the bridge. If you scrape the side of the bridge, you'll hear it, and your car will slow down. If you crash into a bridge, your car will stop altogether, and you'll have to steer around to cross it, while the clock continues to run.

GETTING THE FEEL OF GRAND PRIX™ BY ACTIVISION®

We suggest you take it easy at first. A couple of slow practice runs through the courses will help you get the "feel" of the track.

You'll find that, just as in real racing, the faster your car is going, the easier it will be to lose control. That's why "pacing" is so important. Try to think ahead and anticipate what's coming up.

When you pass another car, you'll almost never have to worry about it catching up with you from the rear. So, keep your eyes on the road ahead. That's where the action will be.

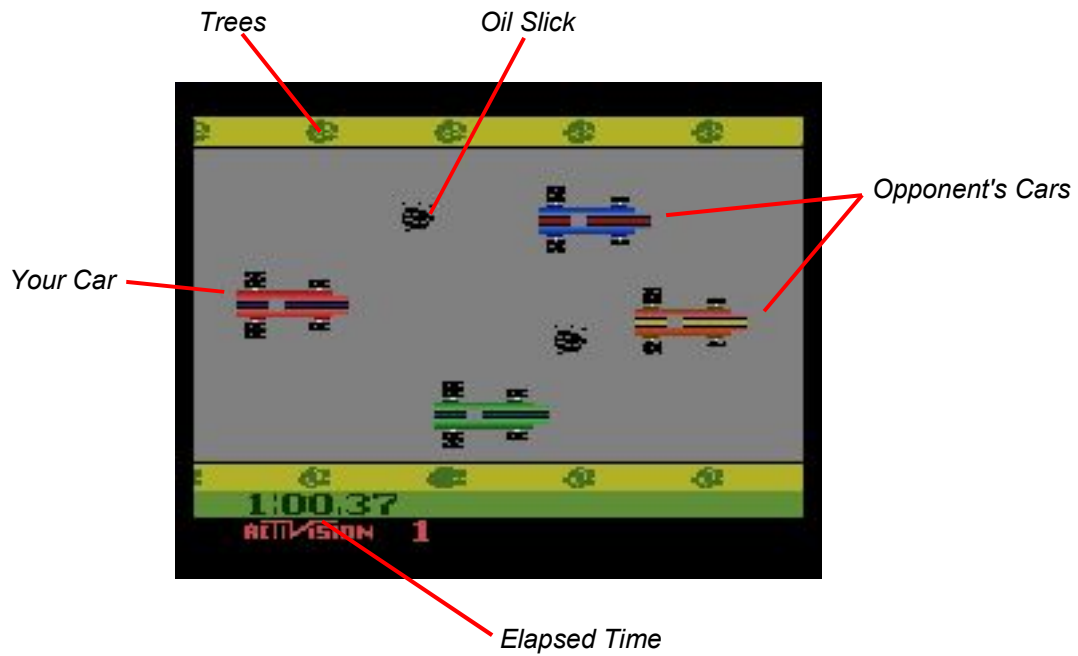

JOIN THE ACTIVISION® GRAND PRIX™ DRIVING TEAM

If you can match or beat any of the following times, we'll make you a member of the Activision® Grand Prix™ Driving Team, and we'll give you a special membership emblem.

Times to beat:	Driving Team Membership	Current World's Record
Watkins Glen	0:35	0:29:61
Brands Hatch	1:00	0:51:06
Le Mans	1:30	1:16:87
Monaco	2:30	2:27:85

HOW TO BECOME A WORLD CLASS RACING DRIVER IN GRAND PRIX™ BY ACTIVISION®

Tips from David Crane, designer of Grand Prix™.

David Crane is an award-winning Senior Designer at Activision. His games include Dragster®, Fishing Derby®, Laser Blast®, and Freeway®.

"Just as in a real Grand Prix race, feel and control are very important in Grand Prix™ by ACTIVISION®. The better you know your car and its responses, the better you'll do.

"Here are some tips. When steering the car up and down the track, press RIGHT slightly on the D-Pad to eliminate any accidental braking. This pressure must be kept light to allow for quick braking in the event of an emergency.

"The more you play the game, the more keenly you'll anticipate the appearance of other cars. To some extent, you'll be able to memorize the traffic patterns and plan moves in advance. If you don't, the slowdown will happen for you in the form of a crash, and you'll pay for it with a loss of valuable time.

"The cars ahead of you have left a lot of oil on the track near the bridges, so, when you see a lot of oil slicks, watch for bridges ahead.

"Knowledge of the course is very important. Learn where you are and what's coming up ahead for each course. That way, time is on your side, which is exactly where you want it to be.

"And drop me a line between races. Good Luck!"



H.E.R.O.™

by John Van Ryzin

1 player

© 1984 Activision Inc.

DUTY CALLS!

Roderick Hero, at you service. Please, call me R. Hero. Everyone does, I wish to address myself to fledgling Heroes and All-Around Good Guys everywhere. A crisis is afoot, affording me an ideal opportunity to share a few of the finer points of heroic endeavor with you. Do pay attention.

Volcanic activity has trapped miners in mineshafts in Mount Leone. I shall use equipment (some think it rather nifty) of my own invention to help miners no mere mortal can reach. It would give me great pleasure to have your help.

The object of this undertaking is to rescue all the miners possible before running out of lives.

MAKING READY!

Do follow these simple instructions. There's a good fellow.

- Please refer to the official manual of *Activision® Anthology* for Game Boy® Advance to review how to setup and select this game.
- Hold the L button and press UP on the D-Pad to select one of five one-player games. The higher the game number, the deeper within the mine one begins and the more advanced the challenge. (See "Rescue Challenge Chart".)
- **To start**, press the SELECT button. Note how Yours Truly hovers in a mineshaft, ready to go once the power gauge turns completely yellow. One need only move the D-Pad to begin.
- **Reserves**. I embark with four opportunities – very well then "Lives" – one in use, three in reserve. One acquires an additional life, to a maximum of six in reserve, for every 20,000 points earned.
- **Power Gauge**. One hears and sees the power gauge fill at the start of each level. Power begins to diminish when the D-Pad is moved at the beginning of each level or after a reserve life appears on the screen. If power runs out and a reserve life remains, one reappears at the top of that level.
- **Game ends** when one runs out of lives, of course.

SOME ESSENTIALS

"Must haves" for the rescuer in the know.

Prop-Pack. My greatest inspiration, to which I'm very attached. This propeller pack allows one to fly where one wishes.

- To fly up: Press UP on the D-Pad
- To run or fly left or right: Press LEFT or RIGHT on D-Pad.
- To hover: Tap UP on the D-Pad.
- To fly down a shaft: Step off the ledge. Gravity does the rest!

Microlaser Beam. The helmet comes equipped with a Microlaser Beam. With it one can blast vile vermin. The Beam can also slice through walls, but this takes time and time costs precious power.

- To fire: Press the A button.
- For continuous fire: Press and hold the A button.

Dynamite. One begins each game and every mineshaft level with six sticks of dynamite, each of which can demolish a small wall.

- Land and move near a wall.
- To place and ignite dynamite: Press DOWN on the D-Pad. Then move fast or be blown up! I, R. Hero, cannot stress this enough.

Raft. A heat-resistant raft floats on certain stretches of the lava river. If it can carry R. Hero across the river when he lands on it (it can), it can carry you. A word to the wise: Getting off isn't always easy!

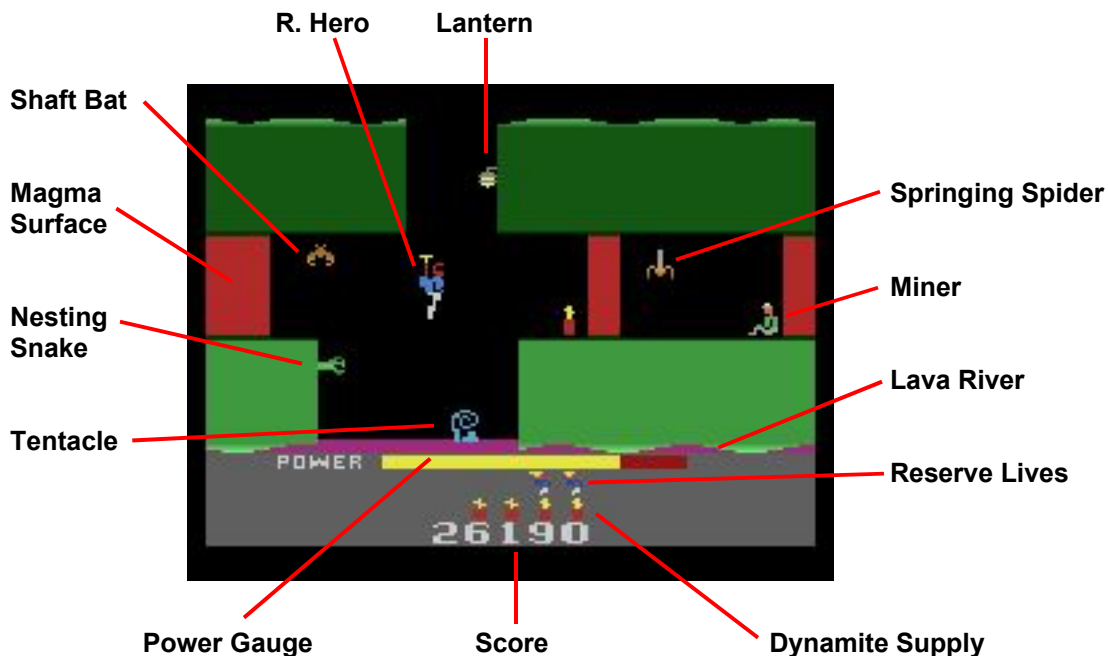

PLANNING THE PERFECT OUTING

One should make it a point to be as familiar with the details of a rescue operation as with guests in one's home. To wit:

Meet the mineshaft. Mineshafts extend vertically and horizontally deep into Mount Leone. Some dead end; others are blocked by walls. Some walls and surfaces glow red; these contain magma deposits, molten lava behind the rock. Like lava rivers, magma deposits cost one a life should one be careless enough to touch them. Oh yes, before I forget. Lanterns light these murky mineshafts. Touch or shoot one and that section of the mine will go dark. Most unpleasant.

Hello to Hazards. The shafts, you will note, are alive with various vermin: Springing spiders, shaft bats, mine moths and nesting snakes. Do avoid them, or blast the loathsome little beggars with the Microlaser Beam. In addition a tentacle traces one's every move over certain parts of the lava river. As one cannot shoot it, practice caution. Touching any of these hazards results in a loss of life, alas.

How Low Can One Go? One must locate a miner on each level before moving lower in the mine. The deeper one goes, the faster things move, the more dangerous and numerous the challenges become and the harder it is to find the miner. The current level number appears in place of the score at the beginning of each level. To tackle tougher tunnels right away, one may start the rescue mission at deeper levels.

RESCUE CHALLENGE CHART

Game Number	Starting Level
1	1
2	5
3	9
4	13
5	17*

* Game 5 starts on level 17, but all following levels are random. No level number appears during game 5.

In games 1 to 4, the word PRO appears in place of the level number after level 20. My highest accolade, you can be sure!

SCORING

- Shoot a critter: 50 points
- Each dynamite stick remaining when miner is rescued: 50 points
- Dynamite a wall: 75 points
- Rescue miner: 1000 points

One earns additional points for every unit of power remaining when a miner is rescued. The higher the level number, the more each unit of power is worth.

The day has been saved when the score reaches 1,000,000. The rescue operation ceases. Can you say what else happens? R. Hero, of course, knows...

JOIN THE ACTIVISION® "ORDER OF THE H.E.R.O."

Score 75,000 points or more and join ranks with R. Hero in the Order of the H.E.R.O.: You'll receive an official Order of the H.E.R.O. emblem.

H.E.R.O.™ HINTS FOR THE HEARTY HERO

Tips from John Van Ryzin

John Van Ryzin collects cameras. He golfs. He camps, and goes canoeing. In addition, he's from New Jersey. But what you must understand about John is, he loves his work. He thrives on it. As proof of this, he belongs to almost every Activision club. No mean feat, that.

"The mineshafts of Mount Leone present many challenges to a rescuer. I recommend you watch the opening sequence before playing the game. It'll give you a feel for the terrain and help you recognize some of the dangers ahead. Also, the more you play, the better you'll learn your way around the different mineshafts. Since speed in locating miners earns you more points, you'll want to move as quickly and efficiently as possible. Here are a few tips I think you might find useful.

- The dynamite R.Hero carries is potent. He doesn't need to be right next to a wall in order to blow it up.
- If R. Hero runs out of dynamite, he can burn through walls with the Microlaser Beam. The closer he stands to the wall, the faster he'll break through.
- If a lantern goes out, find mineshafts by looking at the rough edges along the bottom of the screen.
- When flying above the river, ride the ceiling by pushing up as well as to the left or right.
- Ride rafts whenever possible since it is easier than trying to go under a lava ceiling.
- A word about tentacles: They don't move too fast, so try to outrun them.

Hope that helps some. You'll discover your own techniques as you plumb the depths of the mine. Let me hear what they are when you emerge from 'down under'."

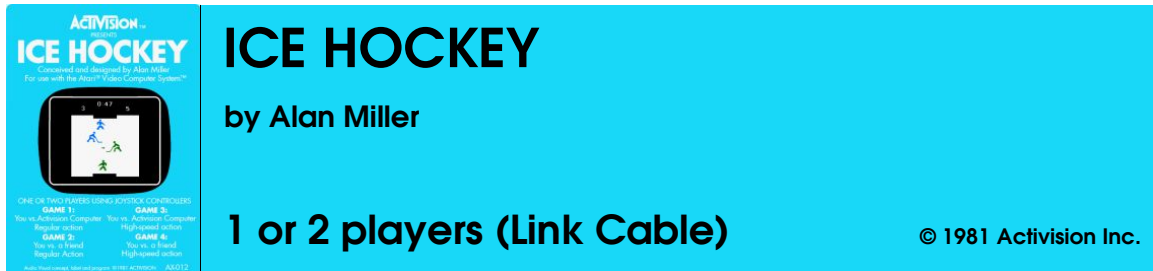

Welcome to the slam-bank world of Ice Hockey. Before you lace up your skates and step out on the ice, you'd better take a minute to read these instructions. Then get ready for some outstanding head-to-head competition!

ICE HOCKEY BASICS

1. Please refer to the official manual of *Activision® Anthology* for Game Boy® Advance to review how to setup and select this game.
2. A two-player game requires the use of a second Game Boy® Advance unit connected with a Link Cable. Refer to the official manual for details on how to set this up.
3. **Difficulty Settings.** Hold the L button and press LEFT on the D-Pad to set the difficulty or handicap for player 1. Likewise, hold the L button and press RIGHT on the D-Pad to set the difficulty or handicap for player 2. The effect is the same in both cases:

- A** – Team's players are handicapped with a 25% skating speed reduction.
- B** – Team's players are not handicapped.

Start with the difficulty settings in the **B** position; **A** should be used by advanced players when playing with a beginner.

4. **Game Select.** Hold the L button and press UP on the D-Pad to select a game:

- Game 1: You against the Activision® computer team. Regular action.
- Game 2: You against a friend. Regular action.
- Game 3: You against the Activision® computer team. High-speed action.
- Game 4: You against a friend. High-speed action.

Note: In Games 1 and 3, you are the blue team; the computer is the yellow team.

5. **To begin play.** Press the SELECT button. Both teams will be in position for a face-off. After a few seconds, the puck will be in play.
6. Player 1 controls the blue team in all games. In Games 2 and 4, player 2 controls the yellow team with the D-Pad and A button of his own Game Boy® Advance unit.

You will be controlling the player on your team who is holding the hockey stick. This will always be the player closest to the puck. Moving the D-Pad in any direction will make the player move in that direction on the ice.

7. **To take a shot.** Press the A button. You can control the angle of your shot depending on **where** the puck is on your stick when you fire. (See "How To Play").
8. **Object of the game.** To score more goals than your opponent in the three-minute time period.

HOW TO PLAY ICE HOCKEY BY ACTIVISION®

Offense

The first thing to do is gain control of the puck, which you do by skating near it. When you've connected, you'll hear a "click" and the puck will begin to move back and forth on your player's stick.

There are 32 shot angles. Your shot will go to the extreme left when the puck is at the left side of your player's stick; it will go to the extreme right when the puck is at the right side of your player's stick. All other shot angles occur when the puck is in between the two extremes. Players can only shoot the puck forward towards their opponent's goal.

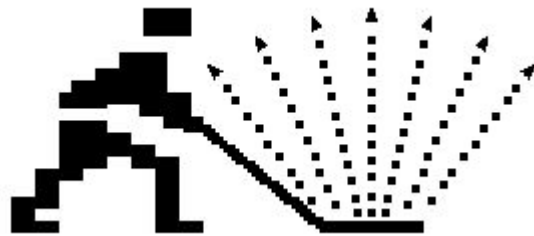

Defense

When on defense, use your stick to knock the puck away, or body-check your opponent to slow his attack.

When you're defending your goal, it's important to cut down your opponent's shot angle, since you want to make it as tough as you can for him to get a clean shot at your net.

Passing the Puck

Ice Hockey is a team game, and you should practice passing from your goalie to your forward. You'll find it impossible to play championship-quality hockey if you don't learn how to move the puck effectively. You have to understand the shot angles to become a good passer.

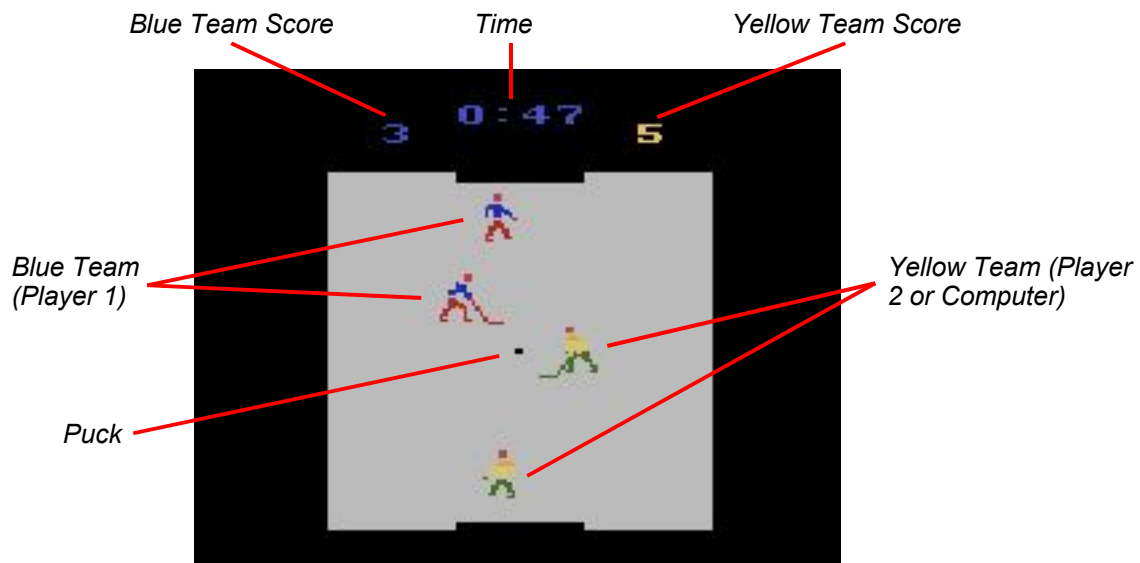

SPECIAL FEATURES OF ICE HOCKEY BY ACTIVISION®

Learn how to "play the boards". Just as in real hockey, you can pass the puck by shooting it off the sides of the rink. This is helpful in moving the puck up the ice, and can be really key when you're in position to score a goal.

In addition to body-checking, there's another way to slow down your opponent: knock him down. If you're close enough to an opposing player, you can swing your stick and occasionally knock him to the ice. Downed players will stay on the ice for a short period, giving you an advantage. Goalies **cannot** be knocked down in front of their goals.

GETTING THE FEEL OF ICE HOCKEY BY ACTIVISION®

One good way to learn some of the game's basics is to get some ice time **by yourself** with Game 2. Move your opponent's players to the sides of the rink and practice shooting and skating. You'll soon get a feeling for the different shot angles, and you'll notice that players have certain movement restrictions. Your forward is prevented from moving too close to his own goal, and your goalie can go only so far away from his goal.

JOIN THE ACTIVISION® "ALL-STAR HOCKEY TEAM"

You'll discover our Activision® computer has a lot of practice skating and scoring goals. So, if you beat him on Game 1, you'll join the ranks of the elite Activision® All-Star Hockey Team, and receive an emblem to that effect.

HOW TO BECOME A STAR AT ICE HOCKEY BY ACTIVISION®

Tips from Alan Miller, designer of Ice Hockey

Alan Miller is a Senior Designer at Activision. A fierce video game competitor, he's also the designer of Checkers and Tennis by ACTIVISION®.

"My Activision® Ice Hockey includes many of the features and much of the speed of real ice hockey.

"You really have to be quick right from the face-off. The player who controls the puck most often will win the game. When you're on defense, don't be too eager to bring your goalie too far out of his net. A smart forward might try for an easy goal by angling his shot off the boards.

"And here's a tip you might not discover, even after hours of ice time. When a loose puck is captured, it's automatically placed on the inside corner of your stick. So, as soon as the puck hits your stick, you can launch an extremely angled shot and surprise your opponent.

"So, lace up your skates and go to it! And drop me a line and let me know how you do".



Krafty Kabobbers are running amok and it's up to you to defeat them all, but beware! The kantankerous Kabobbers are hopping mad and kan hop on, and pop, your army of Buvskies in no time at all! You'll find strength in numbers while bobbing and weaving through the Kabobber grid – promote your Baby Buvskies for extra help in Guvsky busting! Reach Princess Buvsky before she devours the Rainbow Energy and viktory is yours!

KABOBBER™ BASICS

The object of Kabobber is to catch Princess Buvsky before she reaches the magical Rainbow Energy of Kabobberland.

1. Please refer to the official manual of *Activision® Anthology* for Game Boy® Advance to review how to setup and select this game.
2. A two-player game requires the use of a second Game Boy® Advance unit connected with a Link Cable. Refer to the official manual for details on how to set this up.

SPECIAL WARNING: To get the two-player modes of Kabobber working properly on *Activision® Anthology* for Game Boy® Advance, you must perform special steps. See section "Getting Games Two and Four To Work Properly" at the very end of this manual.

3. The difficulty switches are not used in Kabobber. In other words, holding the L button and pressing LEFT or RIGHT on the D-Pad produces no effect.
4. **Game Select.** Hold the L button and press UP on the D-Pad to select a game. (See explanation under "Games" section.)
5. **To start**, press the SELECT button. The action begins immediately!
6. **Use of D-Pad and A button.**
 - To move your group of Buvskies up, down, left or right, press the desired direction on the D-Pad.
 - To promote Baby Buvskies, press the A button.
 - To krush Enemies, move your Buvsky Troops over them with the D-Pad.

7. **Scoring.** You score points by hopping on Enemies. Each Enemy is worth points, depending on the current round of the game, as follows:

Round 1 = 20 points
Round 2 = 40 points
Round 3 = 60 points
Round 4 = 80 points
and so on.

The numbers on the upper left side of the screen indicate the player's score.

8. **Time.** While there is no time clock, you must reach Princess Buvsky before she devours the magical Rainbow Energy field at the end of the grid. Keep a watchful eye on the monitor at the bottom of the screen.
9. **Enemies.** There are several different enemies in Kabobber:
Guvskies = Green Buvsky. They look just like your Buvsky troops, but they're mean and green.
Cholo = Red hat wearing monster. Slightly faster and more elusive than the Guvskies.
Struvskies = Strong Buvsky. These navy blue enemies are extremely strong and extremely fast, but they can be hopped on by an expert player.
Boots = Indestructible, quick, deadly. Avoid them at all costs. Boots cannot be hopped on and can cut through an entire row of Buvskies in the blink of an eye.
Eggs = Stationary, hatch Enemies of all types. Eggs can be hopped on if they are reached before the hatch.

10. **End of game.** The game ends when:

- a) You run out of Buvskies and Baby Buvskies, or
- b) Princess Buvsky reaches and devours the Magical Rainbow Energy.

If you lose all your on-screen Buvsky troops, but still have Baby Buvskies in reserve, the game is not over! Quickly promote the Baby Buvskies to continue playing! Otherwise, they will simply disappear one by one until they are all gone. As long as you have at least one Buvsky on the grid, the Baby Buvskies will remain untouched.

If Princess Buvsky reaches the Magical Rainbow Energy, don't despair! You still have a very brief chance to capture her before she finishes devouring the Energy, so keep on hoppin'!

GAMES

There are four games in Kabobber.

GAME ONE: STANDARD GAME, ONE PLAYER. The game begins on grid one. Only Guvskies inhabit the first grid, and the game difficulty progresses with the successful completion of each grid. New Enemies appear as the game progresses.

GAME TWO: STANDARD GAME, TWO PLAYERS. This game is identical to game one, but two players take turns completing each grid.

GAME THREE: ADVANCED GAME, ONE PLAYER. This game begins on grid three, but is identical to game one in all other respects.

GAME FOUR: ADVANCED GAME, TWO PLAYERS. This game is identical to game three, but two players take turns completing each grid.

SPECIAL WARNING: To get the two-player modes of Kabobber working properly on *Activision® Anthology for Game Boy® Advance*, you must perform special steps. See section "Getting Games Two and Four To Work Properly" at the very end of this manual.

HOW TO PLAY KABOBBER™ BY ACTIVISION®

Put your thumb on the D-Pad and go! That's the only way to become an accomplished Kabobber player! Practice makes perfect. Practice maneuvering your Buvsky troopers around the grid until you get a feel for their movement. **To release Baby Buvskies**, press the A button. You can have a maximum of nine Buvskies on the grid at any one time, so use them wisely. You also might want to experiment with different Buvsky formations to find which particular attack pattern best suits your style of play.

Keep moving. He who hesitates is lost, and he who hesitates in Kabobber quickly becomes hopped on by the band of Enemies. As long as you're moving against them, it's much more difficult for them to crush your Buvskies. Learn the different attack patterns of the Enemies and use that knowledge to your advantage.

Watch out for the dreaded Black Boots. They are indestructible and will quickly stomp any Buvskies in their path. Don't spend too much time going after all the Green Kabobbers either, and keep an eye on the monitor at the bottom of the screen or you'll rapidly lose track of Princess Buvsky!

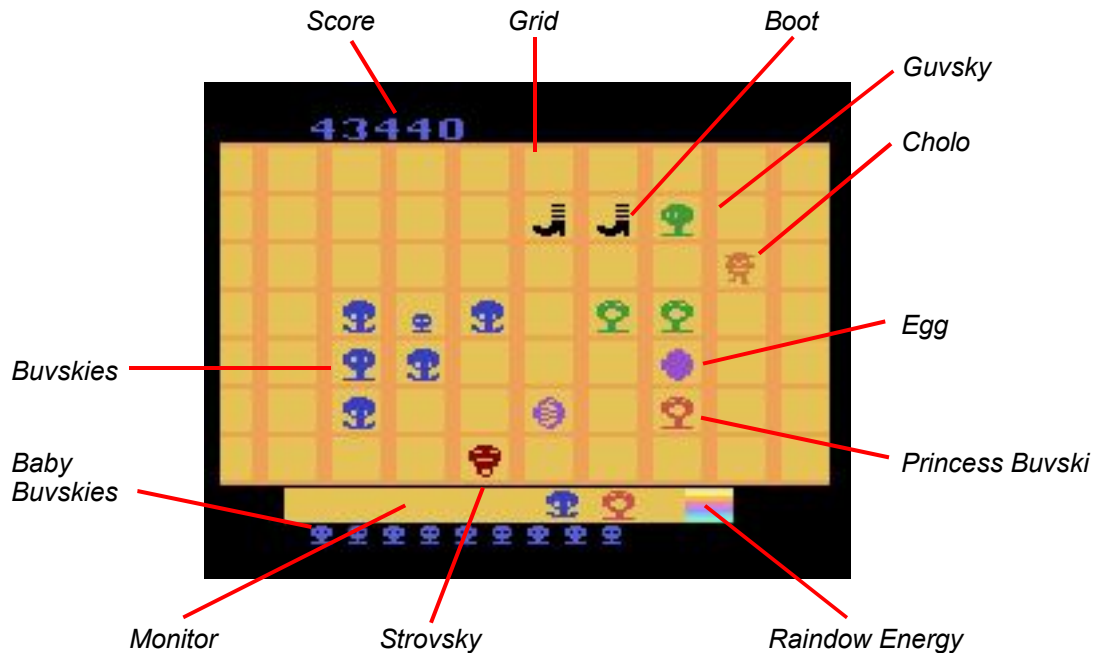

HOW TO BECOME A KING KABOBBER WITH KABOBBER™ BY ACTIVISION®

Tips from Rex Bradford, designer of Kabobber

Rex Bradford is a Designer at Activision. Before creating Kabobber, Rex designed The Empire Strikes Back and Jedi Arena for Parker Brothers.

"It's a 'hop or be hopped' world! When you hop on enemies, you get a free Baby Buvsky in your bottom row. Try to build up a good reserve of Baby Buvskies in the earlier rounds. That way, you'll make sure you have enough Buvskies at your disposal for the later rounds when the going gets rough!

"Really pay attention to the movement of the Enemy Kabobbers. The Cholos, for example, move slightly faster and more erratic than the Guvskies. You might wish to only attack the Guvskies and avoid the tougher opponents altogether, since the same amount of points are scored for any hopped enemy.

"Avoid the Boots at all costs, and stay away from the Strovskies as much as possible. While the Strovskies are able to be hopped, their increased strength and speed makes it a much more difficult maneuver to pull off.

"Drop me a line and let me know about your Ka-battles with Kabobber. I'd love to hear what you think of Kabobber, even if it's got you hopping mad!"

GETTING GAMES TWO AND FOUR WORKING PROPERLY

You may have noticed that when you select to play *Kaboobber* from *Activision® Anthology's* main game menu, there is no message displayed for connecting a second Game Boy® Advance with a Link Cable. This option was inexplicably disabled for this game (perhaps because of unresolved bugs?), which means that player 2 cannot play in Game Two and Four.

And yet, there is a way to make it work! Simply follow these instructions:

1. Select another game with Link Cable support (such as "Kaboom!") from *Activision® Anthology's* main game menu. Do not boot up the game immediately. Instead, get to the screen with the message "To add a second player, please connect a Game Boy® Advance Game Link cable... etc." and let it wait there.
2. Connect player 2's Game Boy® Advance unit with the Link Cable, as described in the official instruction manual.
3. Turn player 2's GBA on, then boot up the selected game on player 1's GBA. The message "Player 2 Ready" should now appear on player 2's GBA screen.
4. Press the START button on player 1's GBA, press the A button exit the game, and go back to *Activision® Anthology's* main game menu.
5. Select "Kaboobber" from the menu, and once you start playing under Game Two or Four, player 2 will be able to play normally!

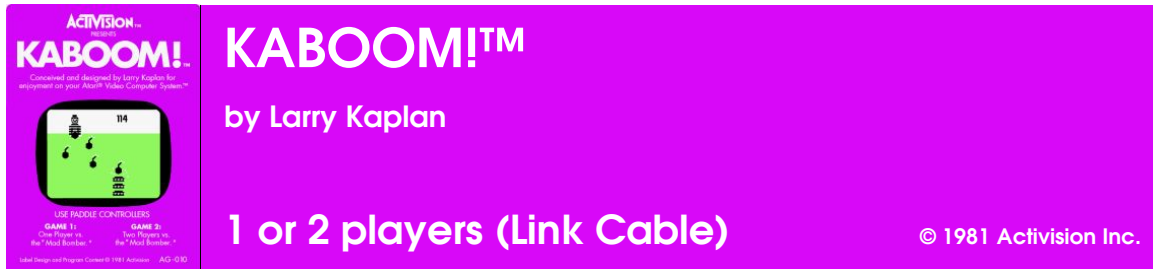

Prepare yourself for a supreme test of reflexes, coordination, and agility. You're about to face the world's most unpredictable and relentless "Mad Bomber". He hates losing as much as you love winning. So, to keep him frowning, take a minute to read over these instructions. Then, grab your buckets and bombs away!

KABOOM!™ BASICS

1. Please refer to the official manual of *Activision® Anthology* for Game Boy® Advance to review how to setup and select this game.
2. A two-player game requires the use of a second Game Boy® Advance unit connected with a Link Cable. Refer to the official manual for details on how to set this up.
3. **Difficulty Settings.** Hold the L button and press LEFT on the D-Pad to set the difficulty or handicap for player 1. Likewise, hold the L button and press RIGHT on the D-Pad to set the difficulty or handicap for player 2. The effect is the same in both cases:
 - A** – Buckets are half size (only for advanced players).
 - B** – Buckets are full size.
4. Hold the L Button and press UP on the D-Pad to select the number of players:
 - Game 1: You versus the "Mad Bomber".
 - Game 2: You and a friend, taking turns versus the "Mad Bomber".
5. **To begin or start a new game.** Press the SELECT button. Then, press the A button to start bombs dropping.
6. Press LEFT or RIGHT on the D-Pad to move your buckets in either direction.

7. **Scoring.** Each time you catch a bomb in one of your buckets of water, you score points. The point value of each bomb depends on how fast that bomb is falling and which group that bomb is in. There are 8 separate groups of bombs, as shown by the following chart.

KABOOM! POINT SYSTEM

Number of Bomb Group	Number of Bombs in Group	Point Value of Each Bomb Caught	Point Value of Group	Cumulative Score
1	10	1	10	10
2	20	2	40	50
3	30	3	90	140
4	40	4	160	300
5	50	5	250	550
6	75	6	450	1000
7	100	7	700	1700
8	150	8	1200	2900

Bomb Group 8 is the highest level. Once you reach this level, all bombs that follow will fall at the same rate of speed and are worth the same points as bombs in Group 8 (unless you miss a bomb – see the next paragraph).

8. **When you miss a bomb**, all bombs explode and you lose a bucket. Lose all three buckets and the game is over. To start over after a miss, press the A button (see "Special Features").

The object of the game is to catch as many bombs as you can and get as close as possible to the 999,999 maximum points.

9. **Two Player Games.** Game 2 is for two players, who take turns against the "Mad Bomber". The score for the first player will be in yellow, and, for the second player, in red. Players alternate turns until both have lost all buckets. The player with the highest score at the game's end is the winner.

SPECIAL FEATURES OF KABOOM!™ BY ACTIVISION®

THE "MAD BOMBER" GETS ONE BY YOU

Sooner or later, it's going to happen. You'll miss a bomb. When you do, all bombs on the screen explode, you lose a bucket, and the "Mad Bomber" expresses his happiness.

Then, depending on which bomb group you're in when you miss, the level of difficulty of the next bombs dropped is affected as follows.

There is **no** change in difficulty when you miss at Bomb Group 1; your next bombs will still be in Group 1. If you're in Bomb Group 2 or above when you miss, you will re-start play at a level one group **lower** than where you were playing when you missed. But, you'll only need to catch one-half the number of bombs normally in that level before making it back to the level at which you missed.

Here's an example: You miss a bomb in Group 4, so you re-start play in Group 3. But you only need to catch 15 bombs (half the normal amount for Group 3) to regain the Group 4 level. Refer to the Point System chart.

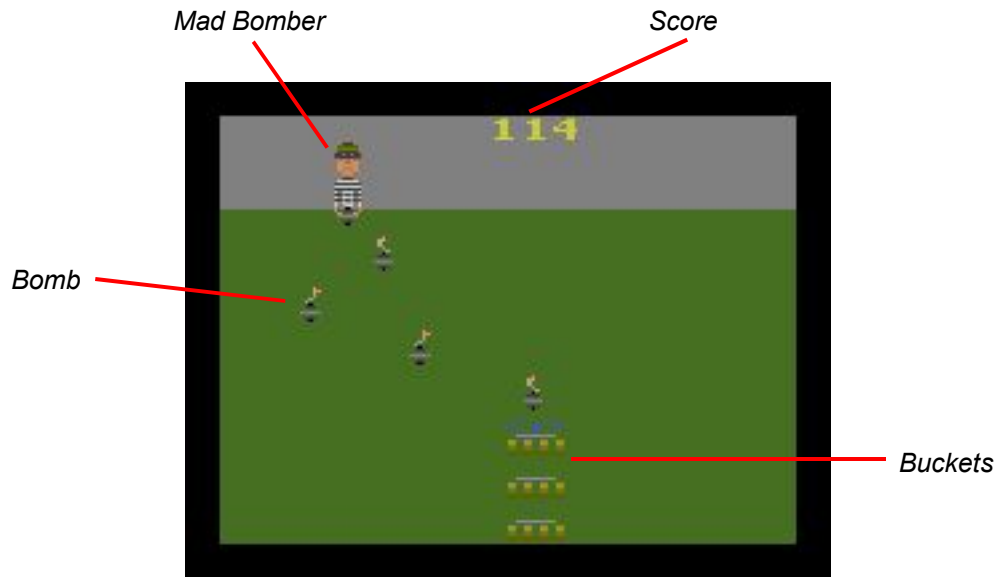

REPLACING LOST BUCKETS

For every 1,000 points you score, you will be given a new bucket (if one or two are missing). However, you may never have more than three buckets, and no additional buckets are awarded if you reach another 1,000 points with no buckets missing.

GETTING THE FEEL OF KABOOM!™ BY ACTIVISION®

There's a method to this madness! And, the more you play, the more you'll see it. Bombs fall a certain way. But **don't** try to aim and line-up your buckets under each bomb. Instead, try to get the feeling for the bomb patterns that develop. After awhile, you'll be able to anticipate where bombs will fall. That's when you can get the jump on the "Mad Bomber".

JOIN THE ACTIVISION® "BUCKET BRIGADE"

If you succeed in scoring 3,000 or more points at Kaboom!, we will enroll you in the Activision® "Bucket Brigade" and give you a special membership emblem.

HOW TO BECOME A MASTER AT KABOOM!™ BY ACTIVISION®

Tips from Larry Kaplan, designer of Kaboom!™

Larry Kaplan is also the designer of Bridge by ACTIVISION®. A senior member of the Activision Design Team, Larry is a well-known expert in the field of video game design.

"To do well at Kaboom!, you'll need all the reflexes, endurance, and concentration you can muster. Don't be frustrated if things don't go well at first. It takes a fair amount of practice, especially to catch the bombs at higher speeds.

"You'll notice that you'll be improving in stages. The first plateau is the 1,000 point mark. Mastery at Bomb Groups 5 and 6 is necessary to do well here. Conquering Bomb Group 7 will place you at the 2,000 point level. As you develop the stamina and concentration needed to progress, you'll conquer Bomb Group 8. From then on, it's a matter of fine-tuning your skills and extending your endurance to improve your score.

"If you hit the 10,000 point level, that really impresses the "Mad Bomber," and he'll show his appreciation. Watch for it.

"Here's one special trick we have discovered to help build up your score while maintaining some control of the game. If you have all 3 buckets and you're just about to cross a 1,000 point level (1000, 2000, 3000, etc.), miss one of the bombs on purpose! You will lose your bottom bucket, but you will start over at the next lower difficulty level. And that'll give you a few bombs to catch at a slower speed. Then, after you've gone over the 1,000 point level, you will get your bucket back anyway, so you haven't lost a thing. Since you will be playing for a while at a slower speed, it gives you a breather, but keeps you in the game.

"If you really become good at Kaboom!, try it with the difficulty set to **A**. Since the buckets are only half the regular size, you'll really have to be quick.

"Please take time out from your bomb chasing to drop me a line. It would be great to hear from you."



CRIME BUSTER'S HANDBOOK

"Officer Kelly reporting for duty. Leaping Leprechauns!! If it isn't Harry Hooligan... up to his old shenanigans. That blunderous hoodlum is robbing Southwick's. And on a Sunday at that! C'mon then... lend a hand. We've got to catch the krook, recover the loot and be careful to boot! Listen up! Don't get KO'd by wild shopping carts, beachballs or biplanes. And get moving! There's not a moment to lose!"

KEYSTONE KAPERST™ BASICS

1. Please refer to the official manual of *Activision® Anthology* for Game Boy® Advance to review how to setup and select this game.
2. The difficulty switches and game select switches are not used. In other words, holding the L button and pressing either LEFT, RIGHT or UP produces no effect.
3. **To start**, press the SELECT button. The timer will immediately begin to count down. You'll begin with Keystone Kelly on active duty and three Kops on reserve.
4. Use the D-Pad and A button to move Keystone Kelly:
 - Keystone Kelly will run to the left or right when you press either LEFT or RIGHT on the D-Pad.
 - Kelly will jump when you push the A button. For a long, running jump, press the A button while pressing LEFT or RIGHT on the D-Pad.
 - Kelly will duck down when you press DOWN on the D-Pad.
 - Kelly will step into an open elevator when you press UP on the D-Pad; he'll step out when you press DOWN.
5. **The Bonus Timer** is beneath your score. It starts to count down as soon as the game begins. When only 10 seconds remain, it flashes. Be warned!
6. **Scoring.** Points are earned each time a Krook is apprehended. The sooner you catch him, the more points you'll get. Krooks 1 through 8 are worth 100 times the amount left on the Bonus Timer. Krooks 9 through 16 are worth 200 times the amount left on the Bonus Timer. After your 16th arrest, each Krook will be worth 300 times the amount left on the Bonus Timer. Also, every recovered moneybag and suitcase is worth 50 points.
7. **Bonus Kops.** Every time your score increases by 10,000 points, a Kop is added to your reserve squad, up to a maximum of three on-screen at a time.

8. **The game ends** when all of your Kops are gone. Any of the following will cause you to lose a Kop:
- Colliding with a biplane (see "Look Out" under "Special Features").
 - Running out of time.
 - Allowing a Krook to escape off the roof.

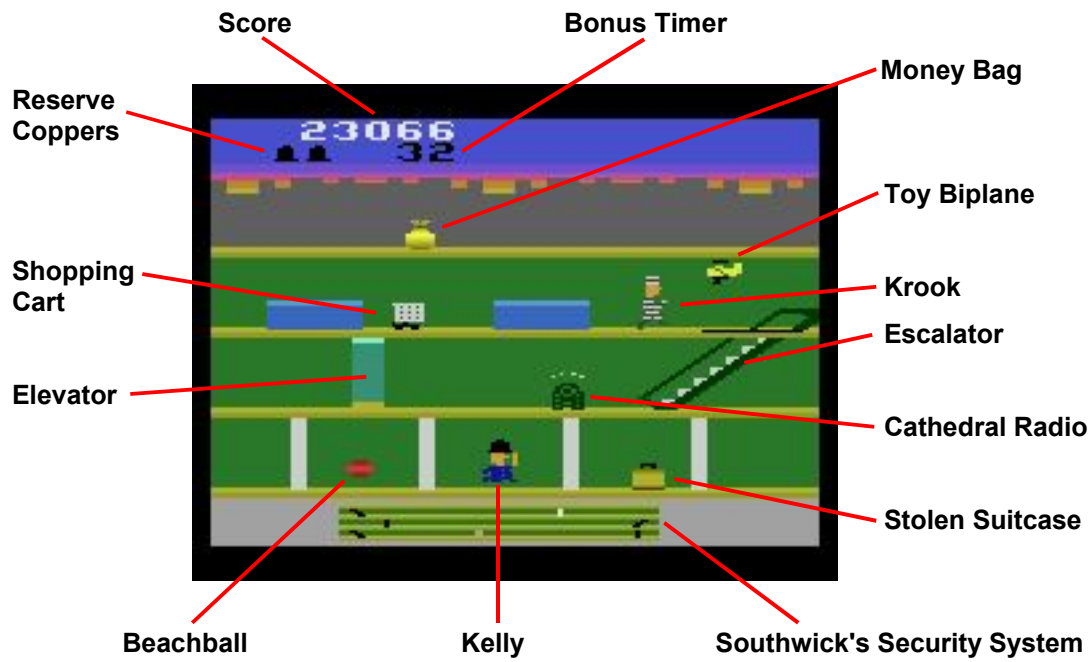

SPECIAL FEATURES OF KEYSTONE KAPERS™ BY ACTIVISION®

Elevators and escalators. The elevator can take Keystone Kelly up and down to any floor except the roof. Place Kelly in front of it and wait until the door opens. Then press UP on the D-Pad to move Kelly into its green interior. Press DOWN to exit. Kelly can also ride up on an escalator just by touching it. An escalator is the only way to get to the roof.

Southwick's Security System. Lucky for you, Southwick's has security cameras scanning the store. The display at the bottom of the screen gives you an overview of all floors, from the bargain basement to the rooftop. Kelly is the black dot, the Krook is the white dot. The elevator is the moving grey square in the middle and the escalators are the black slashes on either end. Using the Security System, you'll know which way Kelly should run to catch an elevator, an escalator or a Krook.

Look out!!! You must **jump** to avoid a rapid onslaught of shopping carts, beachballs and cathedral radios. If you collide, a valuable 9 seconds will be deducted from your time. As your score rises, toy biplanes whizz by. **Duck** to avoid them. With each collision, you'll lose a Kop. However, **DON'T** avoid moneybags and stolen suitcases. You'll earn 50 points each time Kelly picks one up.

GETTING THE FEEL OF KEYSTONE KAPERST™ BY ACTIVISION®

If you're a new recruit to Kelly's force, some basic training is all you need. First of all, practice your jumps – running jumps and jumping in place. Perfect timing is the real key here. Another thing, Harry Hooligan is no dope. He's pretty crafty at switching floors when Kelly takes the elevator. So, when you hop on, watch Harry on the Security System Display (he's the white dot). Don't get off until you're as close to that Krook as possible.

JOIN THE ACTIVISION® “BILLY CLUB”

It all started at O'Shaunessey's Grille. After a hard day of crimebusting, Keystone Kelly and the Koppers would gather in the Bowery joint to share hot tips and potatoes. They called themselves "The Billy Club", and you can join with a score of 35,000 points or more (you'll earn the club's official emblem as a reward). O'Shaunessey's is gone, but the club lives on.

THOSE DASHING MEN IN BLUE

Cops weren't always "cops". They didn't get the nickname until after 1845, when the first police badge was issued. The main ingredient? Copper.

The old-fashioned, helmet shaped hats were made of felt, and used until 1906.

When not ready-in-hand, the wooden billy club, or nightstick, hung in the frog, its own special holder. This was attached to a thick leather belt worn over the jacket and buckled with the police department's insignia.

Thumb cuffs were an early version of handcuffs. The suspect's hands were put behind his back and this small, wooden restraint was screwed tightly around the thumbs. Yoww!!

HOW TO BUST INTO THE BILLY CLUB

Tips from Garry Kitchen, designer of Keystone Kapers™.

Garry is a top-notch designer with a great variety of interests. Besides playing video games, Garry likes to read fiction and draw with pencil and charcoal. He's a natural at ping-pong, too, and loves to travel. We're glad he found his way to Activision®.

"Hi gang. I'll begin by saying one thing: DON'T GET STUCK ON THE ROOF!! Because – surprise! – you can't get back down! To avoid this embarrassing predicament, stay behind the Krook and don't go to the roof until he's up there.

"As your score rises, the beachballs bounce higher. Forget about trying to jump over them. Instead, DUCK! Also, the biplanes and shopping carts start coming in waves, so learn their rhythms and do the "Keystone Strut". To the tune of the shopping carts it's, "Jump...run two steps...Jump...run two steps..etc." To the biplane beat it's, "Duck...run three steps...duck...run three steps...etc." Learn to adjust to changing rhythms.

"And, to save yourself a few steps, have Kelly JUMP onto the escalators. He'll be halfway up already. Now, go out and get those guys! And, when you take a break, write to me. I want a **full** report!"

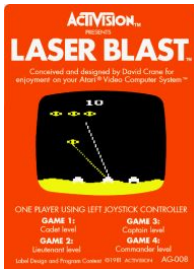

LASER BLAST™

by David Crane

1 player

© 1981 Activision Inc.

Get set for the battle of your life. With Laser Blast™ by Activision®, you're up against enemy attackers in a space shoot-out that defies description. But please, take time out to read these instructions. They're full of helpful hints on how to handle some very relentless adversaries. Good luck and good shooting!

LASER BLAST™ BASICS

1. Please refer to the official manual of *Activision® Anthology* for Game Boy® Advance to review how to setup and select this game.
2. Difficulty switches have no effect. In other words, holding the L button and pressing LEFT or RIGHT on the D-Pad produces no effect.
3. **Game Select.** Hold the L button and press UP on the D-Pad to select a game:

Game 1: Cadet Level Game 3: Captain Level
 Game 2: Lieutenant Level Game 4: Commander Level

NOTE: The difference between games is how rapidly the speed and firing rate of the enemy ground attackers improves as the game progresses. The relative difficulty of an attack group is calculated by multiplying the speed times the firing rate for that group.

GAMES	DIFFICULTY OF GROUND ATTACK GROUPS					
	GROUP ONE	GROUP TWO	GROUP THREE	GROUP FOUR	GROUP FIVE	GROUP SIX or more
CADET LEVEL	1	2	4	8	8	8
LIEUTENANT LEVEL	1	2	4	8	16	16
CAPTAIN LEVEL	1	2	4	8	16	32
COMMANDER LEVEL	1	32	32	32	32	32

The chart above shows how the difficulty of each attack group changes during play of each game. For example, at Captain and Commander Levels, the most difficult attack groups are 32 times as difficult as the easiest.

4. **To begin play.** Press the SELECT button. You can reset the game this way at any time.
5. **Piloting.** The D-Pad is used to pilot your spacecraft. You can only pilot one ship at a time. Press UP to raise your ship and press DOWN to lower your ship. Press LEFT or RIGHT to move your ship left or right. When no direction is pressed on the D-Pad, your ship will hover, spinning in a fixed position (not recommended!).

6. **Aiming and Firing.** The A button is used to fire the ship's laser blaster. Press this button to project the blaster from the bottom of your ship; release the button to fire. The laser blaster can be aimed by holding down the A button and pressing LEFT or RIGHT on the D-Pad. But remember, the blaster will not fire until the A button is released. *Note that you cannot fire until ground targets come into visible range.*
7. **Scoring.** Your score is kept in the upper left hand corner of the screen. You are awarded points for each attacker you destroy. As you progress through the game, attackers are worth more points, but they're also tougher to destroy.
8. **Reinforcements.** For each 1,000 points you gain, you're given a reinforcement ship. You can receive an unlimited number of reinforcements during the game. But, you can only have six reinforcement ships on the screen at one time. No matter how many points you score, you must have less than six reinforcement ships before the computer will add to your fleet.

SPECIAL FEATURES OF LASER BLAST™ BY ACTIVISION®

ENEMY RADAR AND FORCE FIELDS

The ground attack forces are equipped with radar detection systems which help them aim their lasers at your ships. If you allow your ship to hover in one place too long, the enemy will quickly line up your ship in its sights, leading to disastrous results. By flying low to the ground, you can keep your craft under their radar.

However, as the battle progresses, each new wave of enemy attackers has a stronger force field, which gradually forces your ship farther away from the ground, making it an easier target for the attackers' radar to spot. Your ship will be pushed higher and higher into space until you can't go any lower than the very top level. This is when you must be very quick to avoid enemy fire.

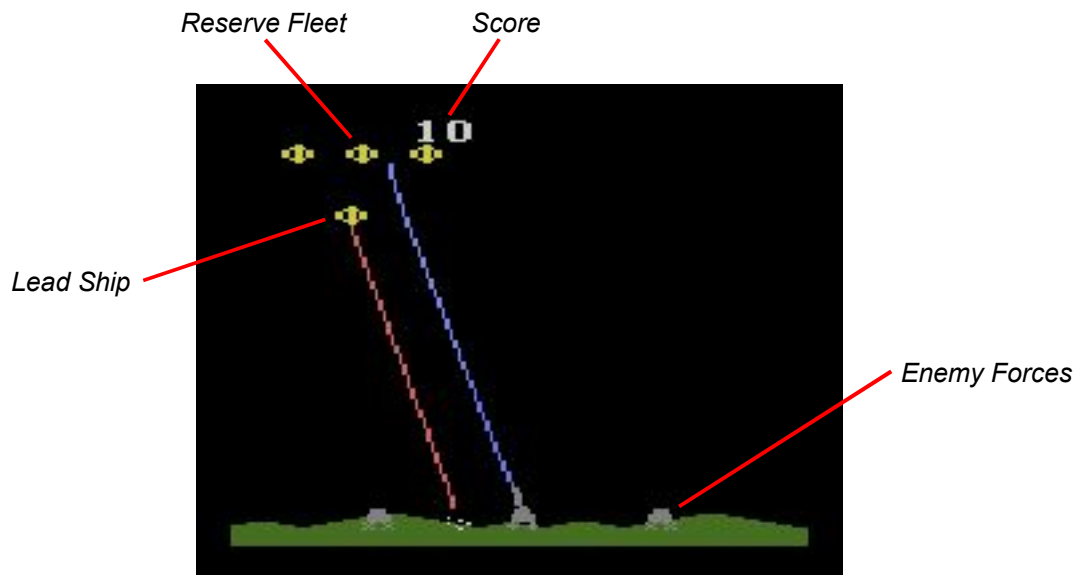

WHEN YOUR SHIP TAKES A DIRECT HIT

Don't give up! Even though your ship will quickly lose altitude after you are hit, you can control the decent of your crippled ship and try to land on an attacker. This accomplishes two objectives: first, it destroys that attacker, and second it adds the value of the destroyed attacker to your point total. After your spaceship has been destroyed, it will be replaced by one of the remaining ships from your fleet (if any). When you're out of ships, the game is over.

GETTING THE FEEL OF LASER BLAST™ BY ACTIVISION®

This isn't an easy game. It takes quick reflexes, concentration and stamina to succeed. We suggest you start out by taking some "reconnaissance" runs quickly over the attackers. Test and see their reactions before you stop and fire back at them. After you've gotten a feel for things, try and master Game 1 before moving on to the much tougher games.

The objective is to "fire and fly" and rack up as many points as possible, to add reinforcements to your fleet and to stay in the fight as long as you can.

THE ACTIVISION® FEDERATION OF LASER BLASTERS

If you succeed in scoring 100,000 points or more, you'll be admitted to the Activision® Federation of Laser Blasters (and earn a special patch in the process). Score the maximum 1 million, and all points on the screen will be replaced with exclamation points. If you score the ultimate, you will receive a second patch!

HOW TO BECOME AN ACE AT LASER BLAST™ BY ACTIVISION®

Tips from David Crane, designer of Laser Blast

David Crane is also the designer of Dragster™ and Fishing Derby™ by Activision®. He prides himself in taking on some of the most challenging game assignments possible.

"As you will quickly discover, Laser Blast is a game not only of skill but also of *endurance*. There's really no time for taking breathers.

"And that brings me to my most important tip. Always keep your ship in motion and fire quickly! A *moving* object is much harder to hit than one standing still. Since the attackers are continuously aiming and firing, you must be quick enough to dodge their fire, move into attack position and destroy their forces. Then quickly move on.

"It is possible to stay in one place and fire quickly enough to destroy your attackers before they zero in on you. But this is a very tough strategy to execute and demands superior skill and concentration.

"The game can get a little frustrating at times. But keep at it and you'll soon be eligible for membership in the Activision® Federation of Laser Blasters. And take time out from your space battles to drop me a line. I'd love to hear from you."



If you think MegaMania™ is just another space game, you're dreaming. And that dream will become a nightmare. A space nightmare. So, prepare yourself for one of the most unreal experiences you'll ever encounter. Read these instructions before you begin. Give yourself a fighting chance.

MEGAMANIA™ BASICS

You control a fleet of mobile blasters at the bottom of the screen, under constant attack by wave after wave of outrageous objects. Your goal is to accumulate points by knocking out as many enemy objects as possible, before your fleet is destroyed. Here's how to start:









1. Please refer to the official manual of *Activision® Anthology* for Game Boy® Advance to review how to setup and select this game.
2. A two-player game requires the use of a second Game Boy® Advance unit connected with a Link Cable. Refer to the official manual for details on how to set this up.
3. **Difficulty Settings.** Hold the L button and press LEFT on the D-Pad to set the difficulty or handicap for player 1. Likewise, hold the L button and press RIGHT on the D-Pad to set the difficulty or handicap for player 2. The effect is the same in both cases:
 - A – (Expert) Missiles travel upward at low speed.
 - B – (Novice) Missiles travel upward at high speed.
4. **Game Select.** Hold the L button and press UP on the D-Pad to select a game:
 - Game 1: One player, with guided missiles
 - Game 2: Two players taking turns, with guided missiles
 - Game 3: One player, with straight missiles
 - Game 4: Two players taking turns, with straight missiles

In Games 1 and 2, you can control the direction of your missile after it has been fired by "steering" it with the D-Pad. Also, you can fire continuously by holding the A button down. In Games 3 and 4, fired missiles streak straight up and your blaster will fire single shots only.

5. **To begin or start a new game.** Press the SELECT button. Your energy bar will charge completely. Once it is charged, the enemy attack will begin.
6. Player 1 uses the D-Pad and A button to play in Games 1 to 4. Player 2 uses the D-Pad and A button on his own Game Boy® Advance unit when it is his turn to play (Game 2 and 4 only).
7. Fire missiles by pressing the A button. Move your mobile blaster left or right across the screen by pressing LEFT or RIGHT on the D-Pad.

8. **Reinforcements.** You begin each game with three blasters in reserve. For each 10,000 points you score, you're given an additional blaster. You can only have up to six reserve blasters on the screen at one time.
9. **Scoring.** Each time you destroy an attacking object, you score points. The point values for each object are listed below:

Megamania™ Point System

Attacking Object	Point Value of Each Attacker (First Cycle Only)
 Hamburgers	20
 Cookies	30
 Bugs	40
 Radial Tires	50
 Diamonds	60
 Steam Irons	70
 Bow Ties	80
 Space Dice	90

These point values apply for the first attack cycle only. After the first cycle, each object is worth 90 points. Each attack cycle consists of all eight waves of objects (see "MegaCycle" under "Special Features").

Bonus Points. You receive bonus points for each energy unit you have remaining at the moment you destroy the last object in an enemy wave. Each energy unit is worth the point value of each attacker in bonus points. For example, in the first wave, if you have 30 energy units left after destroying all the attacking hamburgers, you will be awarded 600 bonus points. There are 80 total energy units in your energy bar in the beginning of each wave.

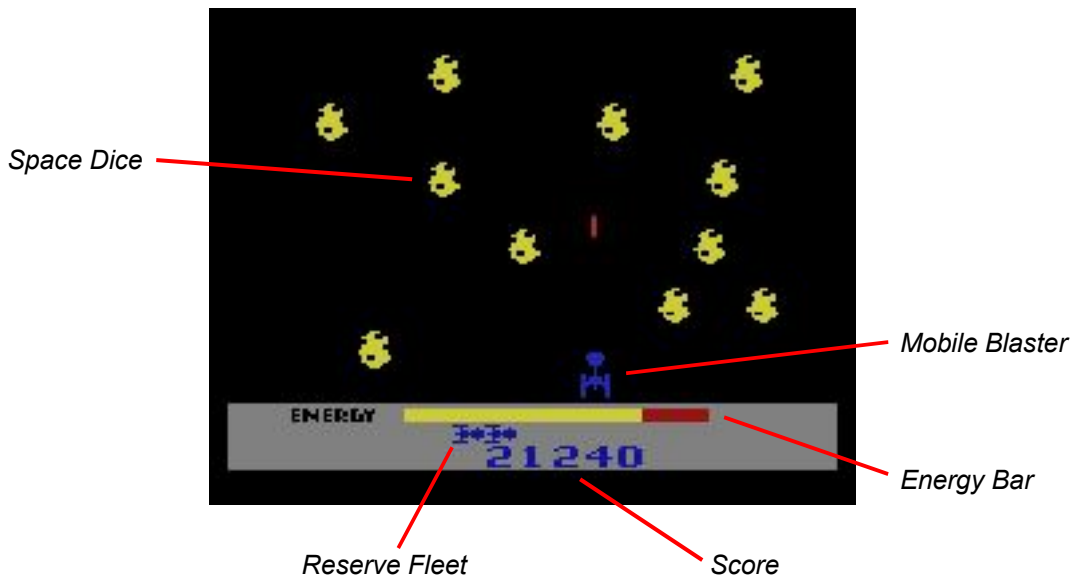

SPECIAL FEATURES OF MEGAMANIA™ BY ACTIVISION®

The Energy Bar. Always keep an eye on your energy bar. It indicates the expenditure of energy with the passage of time. If the energy bar reaches zero, and you still haven't wiped out an attacking wave, you lose your blaster. But, when you completely wipe out a wave, the energy bar will recharge and the next wave will appear.

MegaCycle. When you have destroyed all of the objects in all eight of the enemy waves, you're just beginning. All eight of the waves will return for a rematch. And the better **you** get, the better **they** get. The shapes will be the same, but the colors will be different and the objects will take on more sophisticated motion patterns and evasive actions with each new cycle.

MegaSphere. Each of the enemy objects travels in an orbital path. When an object disappears off the bottom of the screen, it will return at the top of the screen. If an object goes off screen on the right side, it will be back to get you from the left.

GETTING THE FEEL OF MEGAMANIA™ BY ACTIVISION®

To learn to play this game successfully, you'll have to develop a sense of rhythm and anticipation. You do this by becoming expert at the tactics of "Hit and Run".

Always be aware of your position in relation to enemy fire. It takes only a subtle move to dodge enemy disintegrators, but you must move, or you're fried.

Also, if an attacker touches your mobile blaster, you lose that blaster. But, DON'T PANIC! Even though the enemy gets **very** close, you can still destroy them.

Once you have wiped out an entire wave, you have a brief rest while the energy bar recharges. Try and recall the next wave, anticipate and prepare your attack strategy.

HOW TO JOIN THE ACTIVISION® “MEGAMANIACS”

If you reach a score of 45,000 points or more, you will become an official MegaManiac, and receive an official MegaManiac emblem.

HOW TO BECOME A MEGAMANIAC

Tips from Steve Cartwright, designer of MegaMania™

Steve Cartwright is a Senior Designer at Activision. His first release, Barnstorming™, set a new standard for brilliant graphics in the video game industry.

"I hope you enjoy my latest work, MegaMania. Here are a few pointers that I'd like to share with all of my fellow MegaManiacs.

"I recommend that you try to stay in the center of the screen. This keeps you from getting trapped in a corner and also gives you the side-to-side flexibility necessary to guide your missiles effectively.

"And here's a piece of advanced strategy to really help boost your scores: bonus points are awarded depending on your energy remaining at the time you destroy the last object in a wave. So, if you have built up your reserve ships, and you're nearing the end of a wave, go ahead and sacrifice a ship. Your energy will be fully recharged, and, if you can quickly destroy the last attacker in a wave, you'll pick up maximum bonus points.

"It's really wild out there, but please take a couple of minutes and let me know how you're doing. Remember, all of us MegaManiacs are in this thing together!"

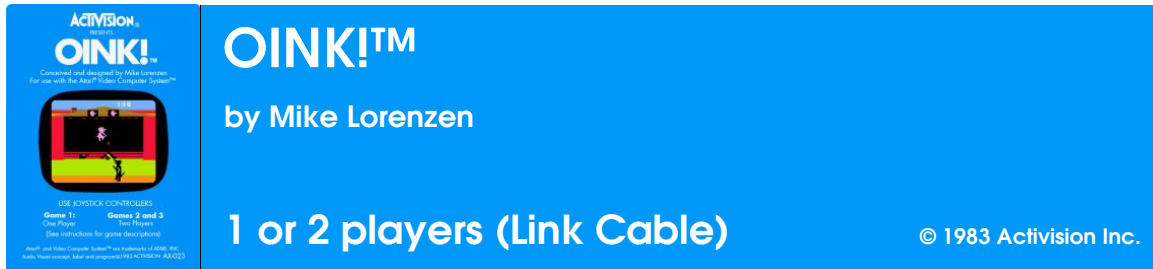

OINK!™ BASICS

1. Please refer to the official manual of *Activision® Anthology* for Game Boy® Advance to review how to setup and select this game.
2. A two-player game requires the use of a second Game Boy® Advance unit connected with a Link Cable. Refer to the official manual for details on how to set this up.
3. **Difficulty Settings.** Hold the L button and press LEFT on the D-Pad to set the difficulty or handicap for player 1. Likewise, hold the L button and press RIGHT on the D-Pad to set the difficulty or handicap for player 2. The effect is the same in both cases:
 - A – Pig must walk down to the wall to drop an object in place. Also, when playing in Game 3, the Wolf will huff and puff a little slower.
 - B – Pig can drop objects from any point on the screen.
4. **Game Select.** Hold the L button and press UP on the D-Pad to select a game:
 - Game 1:** One player (Pig versus Computer Wolf)
 - Game 2:** Two players (taking turns controlling the Pig versus Computer Wolf)
 - Game 3:** Two players (versus game where players alternate between playing as the Pig and the Wolf)
5. **To start a new game,** press the SELECT button. Wait for the Pig to walk to the center of its house. Press any direction on the D-Pad to bring out the Wolf and start the action.
6. Press any direction on the D-Pad to move your Pig in that direction. Press the A button to grab an object; release the A button to drop it in place as a 'patch.'
7. **Scoring.** Points are earned every time your Pig drops an object in place in the wall. Objects in the first row are worth 4 points each. Point values for each object increase by 4 with each new row (see "Row After Row" under "Special Features"). For example, in row 6, each object is worth 24 points. In row 7, each object is worth 28 points.

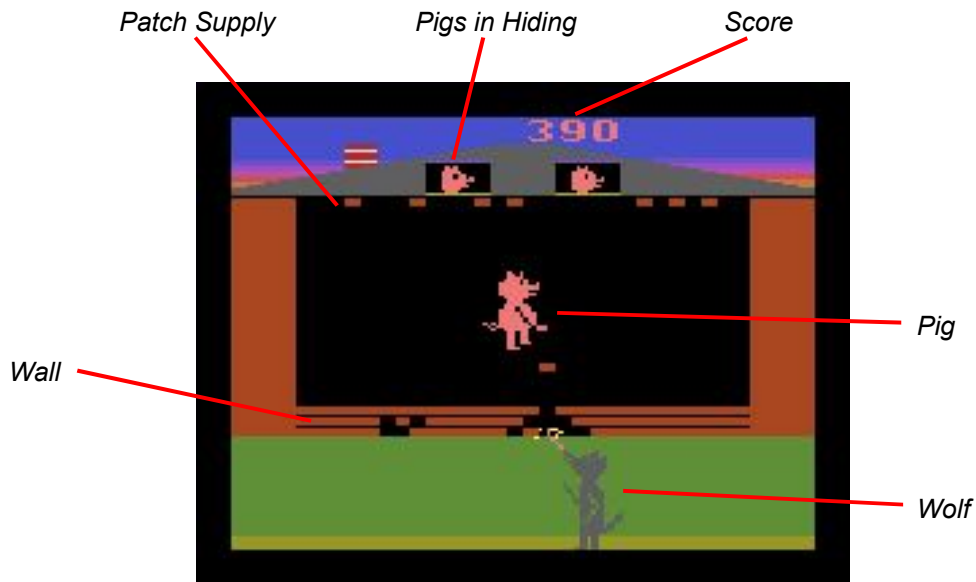

SPECIAL FEATURES OF OINK!™

Three Little Pigs, Three Little Houses. Each Pig defends its own house. The first house is made of straw, so it's yellow. The second is made of sticks, so it's brown. The third house is made of bricks, so it's red. Each time you lose a Pig, you move to the next house and the next Pig.

The Wolf Who Huffs and Puffs. Whether your house is made of straw or sticks or bricks, the Wolf will try to blow it down to get the Pig. He'll blow a little hole here, then a little hole there. And, if you don't keep up with the Wolf, he'll turn little holes into big holes. Then he'll chase after your Pig.

Losing a Pig. If your Pig is struck by the Wolf's breath, he will fall down to the bottom of the wall, losing precious time. And, if the hole is wide enough for the Pig to fit through, the Wolf's breath will take him right out onto the lawn. And then you've lost a Pig.

Row After Row After Row. Every time a row of objects is used up, a new row appears. With each new row, point values increase. But as they do, the Wolf gets tougher and tougher.

If You Can't Beat Him, Join Him. You and a friend can take turns helping the Wolf in his homewrecking crusade. In game number 3, each player will alternately have 3 turns helping the Wolf and 3 turns helping the Pigs. Points are scored only while you're helping the Pigs. At the end of the game, total scores are shown for both players.

JOIN THE ACTIVISION® "OINKERS"

If you reach a score of 25,000 points or more in Game 1, you will join the honorary Oinkers, and receive the official "Oinkers" patch.

HOW TO OINK!™ YOUR WAY INTO THE OINKERS CLUB

Tips from Mike Lorenzen, designer of Oink!™

Mike Lorenzen joined the Activision design team in January 1982. He has an extensive background in video game design and we are pleased to introduce his first work on behalf of Activision.

"If you are helping the Pigs, it's really crucial that you're quick yet calm. You'll soon realize your Pig doesn't need to run all around to get the job done. Just never let a gap get wide enough for a Pig to fit through. Any time a wide space forms, be sure to drop a few objects into it.

"Keep your Pig at the overhead patch supply for quick access. You'll soon find out that he doesn't have to be directly under an object to take it, just in the general vicinity. That should save your Pig some steps.

"Try not to get into the habit of pressing the A button once to grab an object, and then once again to release it. It is much more efficient to HOLD the button down after you've pressed it to grab an object. Then, move the Pig into position, and release the button to drop the object into place.

"If you'd rather help the Wolf, reverse your strategy. You'll want to blow open a gap as wide as possible. Notice that there are three layers of objects. If you've blown one object away, don't move. You're **already** in position to blow out the two remaining objects above it. And watch the Pig. If he's heading toward this newly created hole, blow him down too!

"Whether you play the good guy or bad guy, practice is the real key. But when you need a break, drop me a line. I'll look forward to hearing from you."



OVERVIEW

Okie is a fast moving puzzle game that challenges you with 30 preset puzzles and 435 random puzzles. It seems simple enough: turn off all of the squares. Well, there's a catch! Every time you select a square, it gets "flipped" – if it was on it turns off and vice versa, but to complicate things further, any square directly to the left, right, above, or below the square is also "flipped".

A counter keeps track of the number of moves you make. So you think you are hot stuff for completing level 1 in 756 moves huh? Well, it can be completed in 14 moves!

SELECTING A PUZZLE

Please refer to the official manual of *Activision® Anthology* for Game Boy® Advance to review how to setup and select this game.

When Okie starts, you will see a scrolling message say "SELECT LEVEL". At this point, pressing the SELECT button will cause level 1 to start. Holding the L button instead and pressing UP on the D-Pad will bring the message "LVL01" up underneath the Okie playfield. Tap UP repeatedly on the D-Pad (while still holding the L button) to scroll through the available levels. You can also **hold** UP to make the levels scroll by until you release it.

Okie has 30 preset levels, each one with a unique puzzle to solve. Level 1 has all the tokens on and is fairly difficult. The beginner may want to start with puzzle 2, which is much easier than level 1. The puzzles in level 1 through 15 are fairly symmetrical which makes them slightly easier, while levels 16 to 30 are not symmetrical and thus they tend to be more difficult. Level 31 is a special level that randomly generates 1 of 435 possible puzzles for you to solve.

You can select a new puzzle at any time by holding the L button and pressing UP on the D-Pad, but if you are currently working on a puzzle it will be erased, so be careful! Any time you press the "L + UP" button combination during a game or after solving a puzzle, the level selection will begin at level 1, no matter what level you were previously playing.

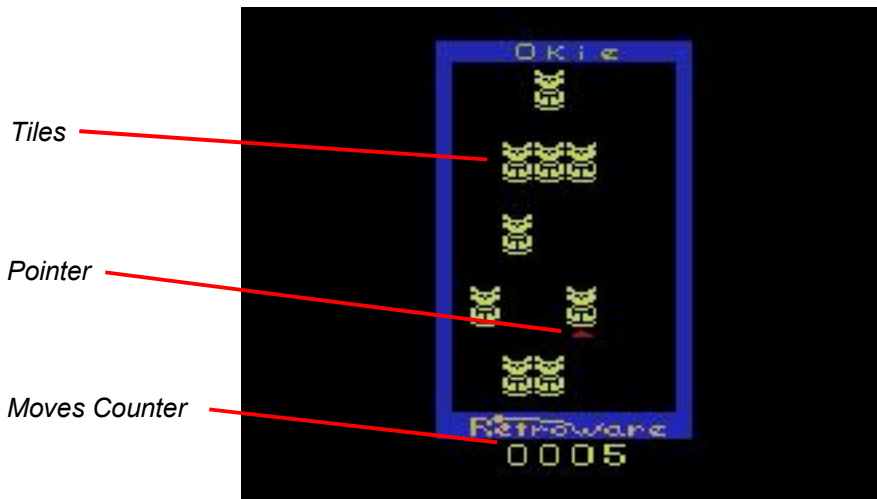

STARTING THE GAME

Pressing the SELECT button will set the "moves" counter to 0000 and randomly pick 1 of 8 different tokens to be used for the puzzle. If you have a favorite token to use, repeatedly pressing the SELECT button will eventually allow you to use it.

If you have selected level 31, pressing the SELECT button will cause the playfield pattern to rapidly change. Releasing the SELECT button will start 1 of 435 possible puzzles that is mathematically guaranteed to be solvable!

USING THE CONTROLS

When you start a new puzzle, you will be able to move a pointer around the puzzle with the D-Pad. Pressing any direction on the D-Pad will move the pointer in the corresponding puzzle direction. If you are in the top row and press UP, the pointer will "wrap around" the puzzle and end up in the bottom row. The "wrap around" feature works for all other directions as well.

Pressing the A button while the pointer is under a token causes that token to disappear. If there is no token above the cursor, a token will appear. This happens to each square to the left, right, above, and below the position the token is pointing to as shown below:

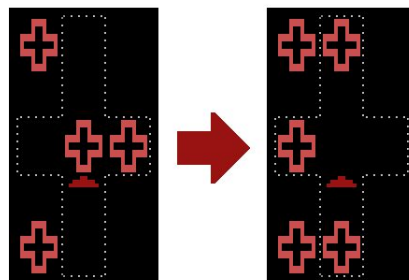

SOLVING A PUZZLE

When you successfully solve a puzzle, a short tune will play and you will no longer be able to move your pointer around. To play the same puzzle again, press the SELECT button. To select a new puzzle, hold the L button and tap UP on the D-Pad to browse through the available puzzles.

Simply solving a puzzle doesn't mean you have mastered it. Level 1 can be completed in 14 moves – Can YOU do it in 14 moves? Level 2 is very simple and can be done in 4 moves, but don't be deceived! Not all puzzles are that easy!

ABOUT OKIE

Okie was written using an Amiga 1200, a Supercharger, the DASM assembler by Matt Dillon and Makewave by Bob Colbert. The goal was to limit the program to 2k to get the "feel" for what classic videogame programmers had to contend with.

DISCLAIMER

Bob Colbert and RetroWare make no guarantees, written or implied, on this software. We are not responsible for any damage due to the use of this software.

CREDITS

Okie would not have been possible without the help and support of the following people:

- Mom and Dad – Couldn't have done it without them, they made me the happiest kid alive when they bought me an Atari 2600!
- My Wife – For putting up with me while I wrote this.
- Dan Borris (Ouphe) – My technical advisor.
- Roloff de Jeu (Deleto) – Designed the label for the cartridge version of Okie.
- Arne Kuilman (Kid-EZ) – Helped Roloff with the label.
- Patrick Wickwire – Supplied me with Atari cartridges.
- John Earney – Supplied me with Atari cartridges.
- Jim Nitchals – Just a nice guy!
- Craig Nelson – Nice enough to give me info on the Supercharger.
- Okie – My cat (R.I.P.), thanks for being there for 18 years!
- The #rgvc IRC channel – When you need to talk to some friendly people, drop on in!

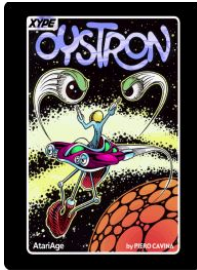

OYSTRON

Homebrew game by Piero Cavina

1 player

© 1997, 1998 Piero Cavina

".....In the Irata solar system lies the planet Stella. It is surrounded by an energy belt. In this belt there live space oysters. They make good food, so there are other outer space creatures living among them, that eat the oysters....."

THE SCREEN

The screen is divided between an upper game area, and a lower status area.

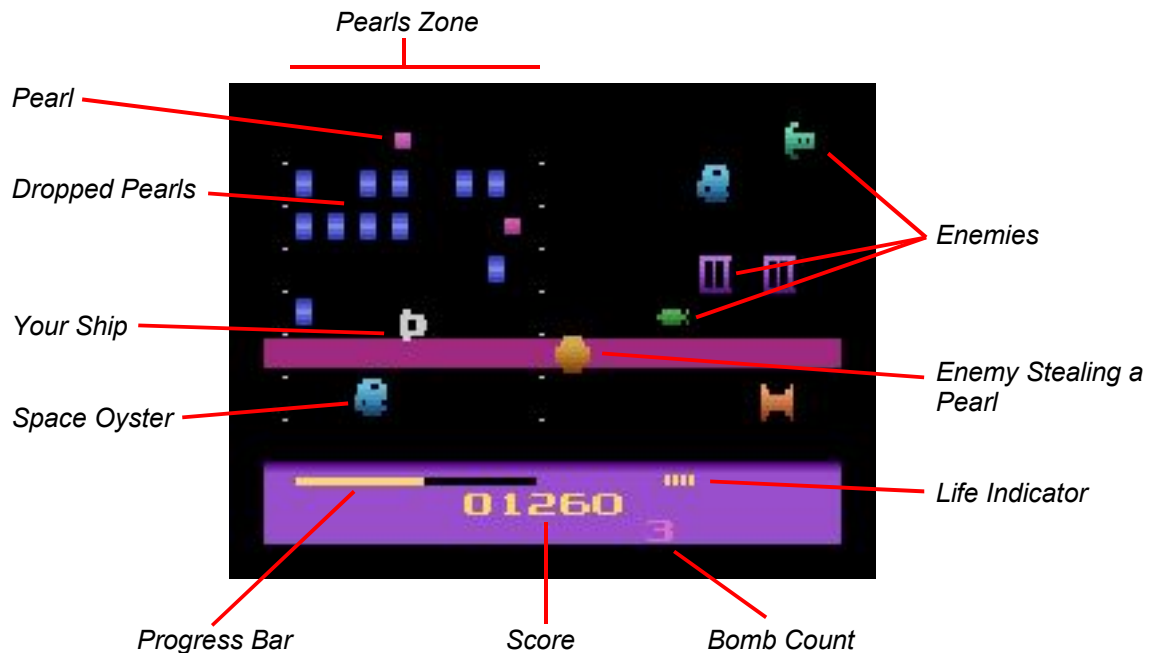

The game area includes the special Pearls Zone, delimited by a grid of white dots. In the status area you can find, from top left to bottom right:

- an horizontal bar, which shows your progress in the current level from the beginning to the Oystron Phase.
- the life indicator, it can show a maximum of 4 lives.
- the score (when playing), or various alternating information when the game is in Game Over status.
- bombs count (when playing), or current variation number.

GAME SETUP

Please refer to the official manual of *Activision® Anthology* for Game Boy® Advance to review how to setup and select this game.

DIFFICULTY SETTINGS

Hold the L button and press LEFT on the D-Pad to set the "bounce" property of your spaceship against the borders of the playfield. When it's in position **B** (advanced), the spaceship will bounce, making the gameplay more difficult. Switch to position **A** (novice) for an easier to control spaceship.

Hold the L button and press RIGHT on the D-Pad to toggle between NTSC and PAL resolution and colors. ***It is not recommended to play the game in PAL mode on the Game Boy® Advance screen.***

CHOOSING A GAME VARIATION

There are three game variations in Oystron: beginner, intermediate and expert. Hold the L button and press UP on the D-Pad to choose the desired game variation. The current variation number is shown in the bottom right part of the status area.

STARTING THE GAME

Press the SELECT button or push the A button to start. You start the game with four lives and zero bombs.

CONTROLLING THE SPACESHIP

Your ship will move in whatever direction the D-Pad is pressed. The A button will fire the missiles. Keep the A button pressed for continuous firing.

The A button has two additional uses:

- Drop off a pearl in the collect zone during normal playing;
- Drop off bombs during the Oystron attack.

GAMEPLAY

Enemies and Space Oysters will enter the screen on the right and attack you moving towards the left border. Some of them will bounce and go back to the right, others will disappear. Learn the behavior of the different kinds of enemies.

Shoot the Space Oysters repeatedly and they will eventually turn into pearls. Collect the pearls and drop them in the Pearls Zone. Your ship glows when it is ready to drop a pearl.

You get a bomb putting 8 pearls in a row.

Beware of the enemies that reach the left border of the playfield, since they will try to steal your pearls. Shoot the thief enemy to rescue the pearls.

Be careful: Stolen or lost pearls will bring undesired guests in... get rid of them as soon as possible!

Oystron phase: Near the end of each level, you'll hear a warning signal and the screen will flash. After a few moments the Oystron will enter and your standard shots will be disabled. From this moment you can either kill him by dropping the bombs and letting him step over them, or wait until he gets bored and mutates into a Space Oyster. You lose the bonus points if you let the Oystron go away. In both cases, you'll enter the Warp phase. If you're killed in the Oystron phase, you'll be put a little back in the level, and you'll have to face the Oystron again.

Warp phase: During the warp phase, you'll travel at high speed between Space Oysters and enemies. The risk of collision will be high, but now everything is worth 100 points! A new level will start immediately after the end of the warp phase, with more enemies and troubles waiting for you.

SCORING

Space Oysters (each hit):	10 points
Enemies (formation destroyed):	30 points
Oystron (killed with a bomb):	1530 points + (number of bombs left) x 100 points

Extra ships: You win an extra ship every 4,000 points. From 75,000 to 99,990 points there are no extra ships. Why? Guess it!

GIMMICK: There's a way start the game near the end of the level with a load of bombs...

OYSTORY

Oystron started in 1997 as an exercise in Atari 2600 programming, when on Stellalist (the Atari VCS programmers mailing list) we were discussing about how to reuse a sprite to put more objects on the screen. After many lines of code I realized that I almost had all the elements for a full game. This was only the beginning of the real challenge: the Atari 2600 is a classic videogame system, so this had to be a game with a true classing feeling. I've tried to recreate the fun and excitement of the great early games, so you may find elements of Sinistar, Defender and Rip Off in Oystron.

AWARDS

Oystron won the first (and only) Stellalist contest in 1998.

ACKNOWLEDGEMENTS

That this project wouldn't have been possible without Stellalist, the Atari 2600 programmers mailing list.

Thanks to the nice people on the list I have found the encouragement, the information and the advice needed to bring this project to completion. Jim Nitchals deserves a special mention, because he helped me a lot in optimizing the 6502 code. You should see what he can do to save just 1 byte! Without his help some features, like the Swiss-cheese guys, wouldn't have been possible.

Also, I received a lot of encouragement and gameplay advice from Glenn Saunders, and I can't avoid mentioning Eckhard Stolberg, Nick S Bensema, Robert Colbert, Greg Troutman...

FINAL WORDS

Have a lot of "classic" fun with Oystron. Isn't this the game you would have bought for Christmas 1981?!

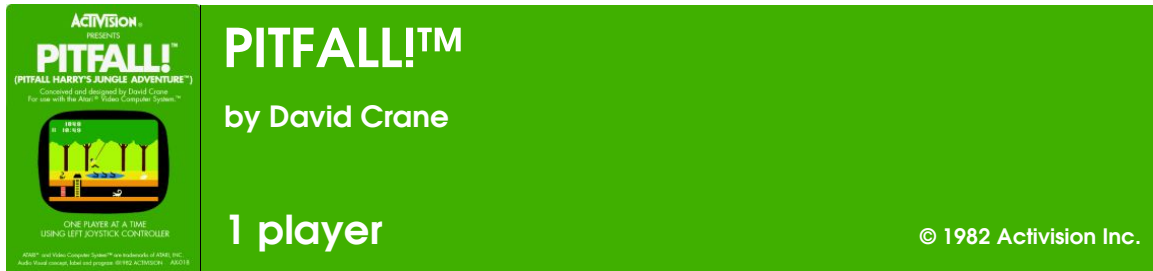

Picture this! You are deep in the recesses of a forbidden jungle – an unforgiving place few explorers ever survive. But you've got courage, because you're with Pitfall Harry, the world famous jungle explorer and fortune hunter extraordinaire. The lure of hidden treasure draws you and Harry deeper and deeper into the bush. But, being a great explorer, you wouldn't think of starting such a difficult journey without reading this manual first – very carefully.

PITFALL!™ BASICS

The object of Pitfall! is to guide Harry through a maze of jungle scenes, jumping over or avoiding many deadly dangers, and helping Harry grab the most treasures in the shortest possible time.

1. Please refer to the official manual of *Activision® Anthology* for Game Boy® Advance to review how to setup and select this game.
2. The difficulty and game select switches are not used in *Pitfall!*. In other words, holding the L button and pressing any direction on the D-Pad produces no effect.
3. To start, press the SELECT button. Action begins as soon as you move the D-Pad.
4. **How to play:**
 - To run left or right, press LEFT or RIGHT on the D-Pad.
 - To jump over dangers, press the A button while running to the right or the left.
 - To climb up or down ladders, press UP on the D-Pad to climb, press DOWN to descend.
 - To grab a swinging vine, press the A button while running to the right or to the left. To let go of the vine, press DOWN on the D-Pad at the end of a swing.
 - To collect a Treasure, just run right to it.
5. **Scoring.** You start each adventure with 2000 points. Some misfortunes will cause a deduction of points. Should you fall down a hole by accident, you will lose 100 points. Rolling logs will also cause point loss depending on how long contact is made with them.

Each treasure you find will add points to your score. There are eight of each type of treasure in the entire game, 32 in all, for a total of 112,000 points. A perfect score is 114,000 points (reached by collecting all treasures, without losing any points by falling down holes or tripping on logs).



6. **Time.** You have 20 minutes to complete each adventure. Harry has 3 lives in each game (See "The Hazards of Pitfall!"). Game is over when Harry is "lost" for the third time or when time runs out.

SPECIAL FEATURES OF PITFALL!™ BY ACTIVISION®

There are 255 jungle scenes through which Harry can travel. Each scene covered underground is equivalent to three on the surface. *Pitfall!* is a circular maze, which means that, if Harry safely goes through all 255 different scenes, he will come back to the starting point. In the course of that journey, Harry will also encounter all 32 treasures.

THE HAZARDS OF PITFALL!™

Pitfall Harry's Jungle Adventure is fraught with danger. Some hazards will slow him down and rob you of points, while others will stop him cold in his tracks. The "lesser" hazards are the open holes in the ground and rolling logs (See "Scoring"). The catastrophic hazards are the scorpions, fires, cobra rattlers, crocodiles, swamps, quicksand and tar pits. These obstacles will not cost you points, **but** they will cost one of Harry's 3 lives.

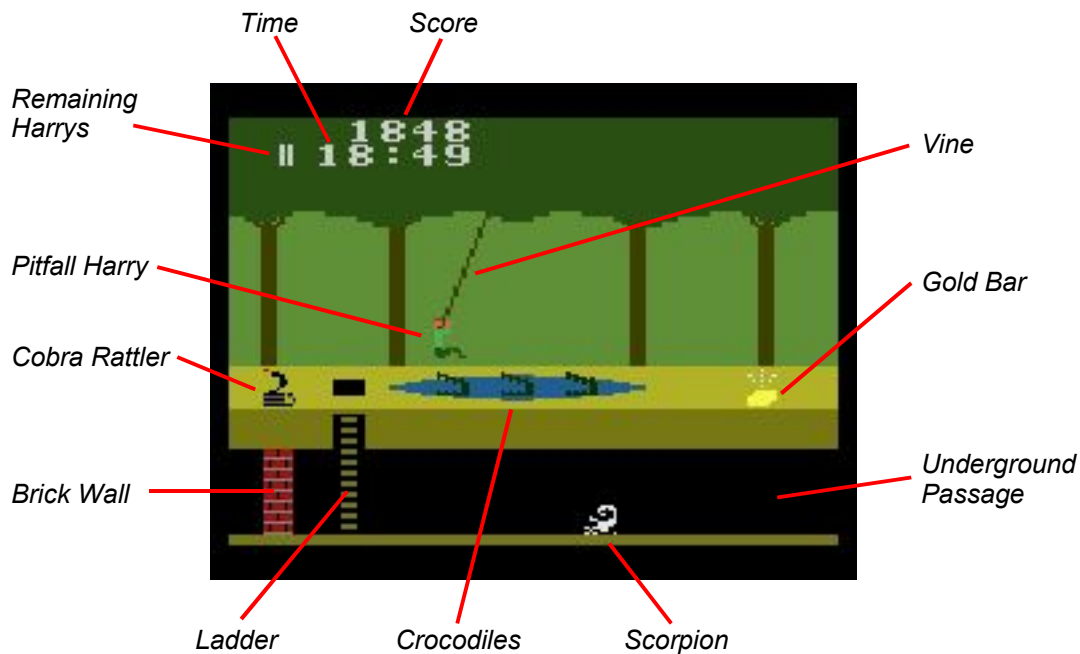

GETTING THE FEEL OF PITFALL!™ BY ACTIVISION®

You cannot excel at Pitfall! without acquiring a variety of skills. The most important is "jumping". You'll need to use both the A button **and** D-Pad at the same time in order to make Harry jump up to a swinging vine. Jumping is also important when you leap atop crocodile heads while crossing the swamp **or** when you hurdle over logs, holes, scorpions, fires and snakes. Special care should be taken when you jump scorpions; the margin for error is less.

To practice your skills, try running to the right. Learn to jump the rolling logs and the holes in the ground first, then tackle the tougher skills of swinging on the vine and jumping over the crocodile pits. Whenever Harry is lost, you'll get another chance to try the hazard again, since the "replacement" Harry appears on the left side of the screen.

JOIN PITFALL HARRY'S EXPLORERS' CLUB

If you score 20,000 points (or more) on any one of your adventures with Harry, you will be eligible to join this prestigious organization, and you will be presented with the special Explorers' Club membership emblem.

HOW TO SEEK YOUR FORTUNE WITH PITFALL HARRY

Tips from David Crane, designer of Pitfall!™

David Crane is a Senior Designer at Activision. He also designed Dragster®, Fishing Derby®, Laser Blast™, Freeway™ and Grand Prix™.

"As you set off on your first adventure with Harry, you'll notice two important features: that the logs always roll from right to left, and that the "replacement" Harrys (after Harry loses a life) drop from the trees on the left side of the screen. So, to minimize the number of rolling logs to be jumped and the catastrophic hazards to be re-tried, simply run to the left.

"Pitfall Harry's trip must be made through a maze of surface and underground passages through the jungle. To capture all 32 treasures in under twenty minutes, Harry will have to use some of the underground passages. I'd suggest that you make a map of the terrain each time you play. Knowing the jungle and planning the best route to all treasures is the only way to insure success time after time.

"Until you get really skilled at making Harry jump from croc to croc, you might wait until the crocodiles' jaws are closed, jump to the top of the first croc's head, then wait for the jaws to open and close again before jumping to the next one. Soon you'll be skipping across crocs like they were stepping stones in a stream.

"If you can find any writing materials deep in the jungle, drop me a line. I'd love to hear how you and Harry are getting along."



PITFALL II – LOST CAVERNS™

by David Crane

1 player

© 1984 Activision Inc.

PITFALL HARRY'S DIARY

We were all pretty worried about Pitfall Harry. We sent him and his niece, Rhonda, along with Quickclaw the cat, on a treacherous journey to an underground cavern. Well, not a word was heard from him – until today. We now present you with Pitfall Harry's diary – the journal he's been keeping in the lost caverns. It arrived this morning by carrier condor. Typical of Harry.

Before you start reading, let's get your gear together. Here's the basic set-up:

- Please refer to the official manual of *Activision® Anthology* for Game Boy® Advance to review how to setup and select this game.
- **The difficulty and game select switches are not used.** In other words, holding the L button and pressing any direction on the D-Pad will produce no effect.
- **To begin a new game**, press the SELECT button.
- **To start the action**, press any direction on the D-Pad.
- **The D-Pad and A button do many things.** Certain maneuvers really require practice.
 - To move Pitfall Harry left or right, press LEFT or RIGHT on the D-Pad.
 - To jump, press the A button. For a running jump, press the A button while pressing LEFT or RIGHT on the D-Pad.
 - To descend a ladder, press DOWN on the D-Pad **just before** Pitfall Harry reaches the hole. To ascend a ladder, press UP.
 - When Pitfall Harry travels by balloon (see 'Balloons') the balloon will follow the left and right movements of the D-Pad. To speed it up, press UP; to slow it down, press DOWN.
- **There is no time limit.** You and Pitfall Harry can explore the lost caverns as long as you wish.
- **The journey ends** the moment Rhonda, the Raj diamond and Quickclaw have all been found.

And now... the diary.

IN CASE YOU'RE WONDERING WHY I'M HERE

Perhaps I've gone too far. I'm in an underground cavern beneath Peru. It seems to be a complex maze, perhaps eight chambers wide and over three times as deep. Niece Rhonda has disappeared, along with Quickclaw, our cowardly cat. I am beset by all manner of subterranean creatures in this vast, ancient labyrinth. And all because of a rock – the Raj diamond. It was stolen a century ago, and hidden here.

Old friends, if ever you see this diary, I hope you'll read it and come to my aid. Help me find Rhonda, Quickclaw and the diamond. On the way, let's also look for a stone-aged rat. A large university wants it for research. Finally, lots of stolen U.S. gold bars were ditched here. The more bars we recover, the more "brownie" points we'll get at journey's end.

For the record, if I want a perfect evaluation (199,000 points), I must find Rhonda, Quickclaw, the diamond, all 28 gold bars, and the rat. And never fall victim to a single danger. Again though, my contract only requires the recovery of Rhonda, Quickclaw and the diamond. Everything else is gravy.

But oh... danger prevails. Poisonous frogs, bats, condors, electric eels, albino scorpions. And leaps over dark voids that dare me to fall to their fathomless depths. All of these pitfalls must be avoided. I'm not really sure what'll happen, should I succumb, but it can't be good. I'll check it out tomorrow.

NEXT DAY: THE CONSEQUENCES

Red Crosses are as good as gold – go for them! They'll never believe this when I get back but it's like this: whenever I succumb to any danger, I'm not put out of commission, as one might think. Instead, I'm magically transported back to the last red cross I touched!

Here's my theory: These caverns are part of a land long inhabited by the Incas. This great civilization must have energized healing, and these ancient crosses mark their locations. Their magic is still potent.

BALLOONS!??

Today I was really out on a ledge. Suddenly, a balloon floated overhead – a perfect cross-cavern transport. I wasn't about to ask questions, but I was curious. Upon closer inspection, I discovered that these "balloons" were actually the specimen bags Rhonda was carrying. She must've inflated them with steam from an underground geyser, to signal that she was still alive. Dear, ever-resourceful Rhonda.

Anyway, just jump up and hang on. Float above the ledge you're headed to and wait for a bat to burst the balloon (that's the only way to let go). You'll gently fall onto the ledge. Careful now. You want the bat to get the balloon. Not you.

Oh, yes – Balloons only appear up and down the length of one specific shaft.

GREAT LEAPS IN FAITH

Courage and confidence may be necessary to leap across fathomless voids, but believe me, you can do it!

When you want to cross a shaft, especially the one with no balloons, stand at a ledge's edge and jump diagonally down to the ledge across the way. Press the A button right before you jump and hold it down as you move the D-Pad in the direction you're heading. You'll float to the other side or bounce off the shaft walls.

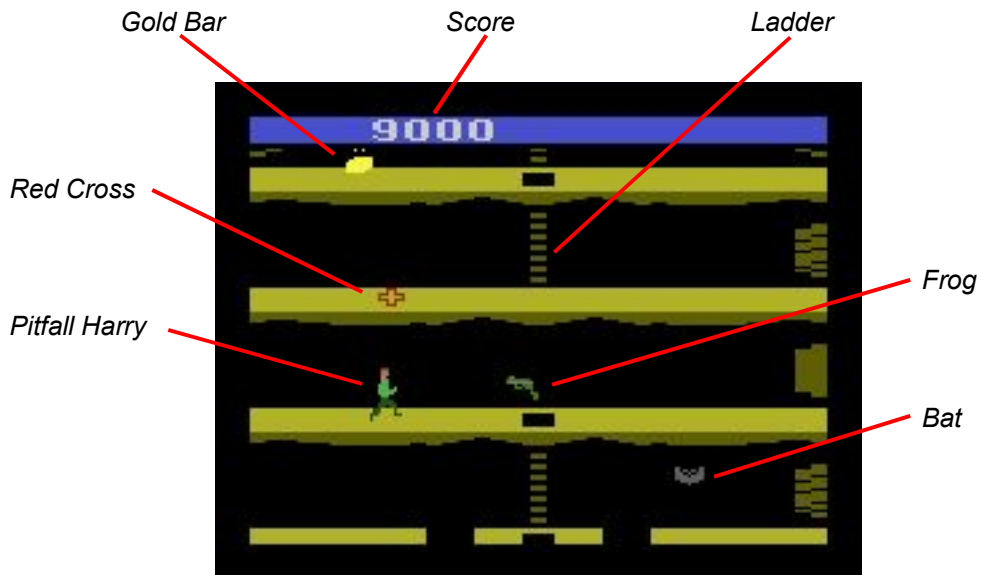

JUST REWARDS

Sure, I love adventure. But let's give credit where credit is due. These are the amounts I agreed to before I left:

** We're given an advance of 4000 points as soon as we begin.*

Thereafter, we'll receive:

- * 5,000 points for every gold bar*
- * 15,000 points for the primitive cave rat*
- * 20,000 points for the Raj diamond*
- * 10,000 points for Rhonda's safe return*
- * 10,000 points for Quickclaw's safe return*

Now hold on. Each time I succumb to a hazard, I'll continually lose points as I regress back to the last healing station (red cross) I contacted. The longer that journey, the more points I'll lose. Also, 100 points are deducted for every unintentional fall.

HARRY STEPS ASIDE

While floating on a balloon today, I realized that it is unfair of me to take all the credit for what we do together. I hereby establish the Activision® Cliffhangers – open to any co-adventurer who collects 99,000 points or more. If you complete this feat, I'll give you the official Cliffhangers emblem.

FAMOUS LAST WORDS OR WHAT DAVID CRANE TOLD ME BEFORE I LEFT

Since David taught me everything I know, I thought I'd share this letter:

Dear Pitfall,

Good luck in the Lost Caverns! Here are some tips that'll help you out:

Time your approach to condors and bats so that you run exactly below their highest elevation.

A free-fall down an entire shaft can be a short-cut to the river below. This particular jump must be timed, though, to avoid colliding with bats on the way down.

If you're **unintentionally** falling down a chute of ladders or past many levels, press LEFT or RIGHT on the D-Pad. The underground wind will **slowly** move you in that direction.

Don't get discouraged if a bat gets you whenever you go from a ladder to a gold bar. Listen up. Stay low on the ladder, wait until a bat is just over you, **then** climb up quickly and run to the gold bar. You'll barely miss the next bat, but miss it you will.

Finally, not everything you **see** is always easy to **get** to. Some things can be so close, yet so far away. Like Quickclaw, for instance. And the rat... who, incidentally, can only be subdued from behind.

Good luck and don't forget to write.

David Crane

David Crane is one of the most highly awarded video game designers in the world. Born in Indiana, he now lives in California and is an avid tennis player. His numerous works include The Activision® Decathlon and, of course, the original Pitfall!™

With that, I'll bid farewell, my friends. I hope to see you soon!

Pitfall Harry

P.S. Please write to David for me. I've run out of paper!



ACTIVISION® DENTAL DEFENSE MANUAL

Flash! Across America, awful jawfuls of junk food are causing deadly dental decay. Plaque is spreading its invisible film, turning teeth yellow as they decompose before our very eyes. Blast this junk with toothpaste before it gets to your teeth! And don't let up. This is the Plaque Attack™, by cuspid, the last stop before gum city!

1. Please refer to the official manual of *Activision® Anthology* for Game Boy® Advance to review how to setup and select this game.
2. A two-player game requires the use of a second Game Boy® Advance unit connected with a Link Cable. Refer to the official manual for details on how to set this up.
3. Holding the L button and pressing LEFT on the D-Pad will allow you to set the continuous firing rate of player 1's tube. Likewise, hold the L button and press RIGHT on the D-Pad to set the continuous firing rate of player 2's tube. In both cases, setting the firing rate to **B** will cause fast continuous fire from your tube when you hold down the A button. Set the firing rate to **A** for slower continuous fire.
4. **Game Select.** Hold the L button and press UP on the D-Pad to select a game:
 - Game 1: One player. Advanced. Difficulty and points increase rapidly as your score rises.
 - Game 2: Two players. Same as above.
 - Game 3: One player. Beginner. Less rapid increase in difficulty, less rapid increase in points.
 - Game 4: Two players. Same as above.
5. **To start**, press the SELECT button.
6. Press LEFT or RIGHT on the D-Pad and you'll move left or right. Press DOWN and you'll aim toward the lower mouth. Press UP and you'll aim toward the upper mouth. Press the A button to squirt the toothpaste.
7. **Time is a factor.** As soon as you press the SELECT button, you'll have 35 seconds to wipe out each wave of food. Your tube will shrink as time runs out.

8. **Scoring.** Points are scored each time you shoot a food article. Bonus points are received at the end of every wave for each tooth remaining and for each second of time left. For example, if you've shot all the food in wave 2, with 10 seconds remaining (100 bonus points) and 8 teeth remaining (160 bonus points), you'll receive a total of 260 bonus points (see chart). After the eighth wave, the scoring peaks, and the food cycle repeats.

WAVE	FOOD	POINTS PER HIT	POINTS PER REMAINING SECONDS	POINTS FOR EACH REMAINING TOOTH
1	Hamburgers	5	5	5
2	Hot Dogs	10	10	20
3	Fries	15	15	45
4	Strawberries	20	20	80
5	Gum Drops	25	25	125
6	Donuts	30	30	150
7	Candy Canes	35	35	175
8	Ice Cream Cones	40	40	200

9. **Bonus Teeth.** You begin with eight teeth in your mouth. With each increase of 2000 points, a bonus tooth will appear beneath your score. Bonus teeth are automatically placed in your mouth at the beginning of the next wave.

10. **The game ends** when you've lost all your teeth and have used up all your toothpaste.

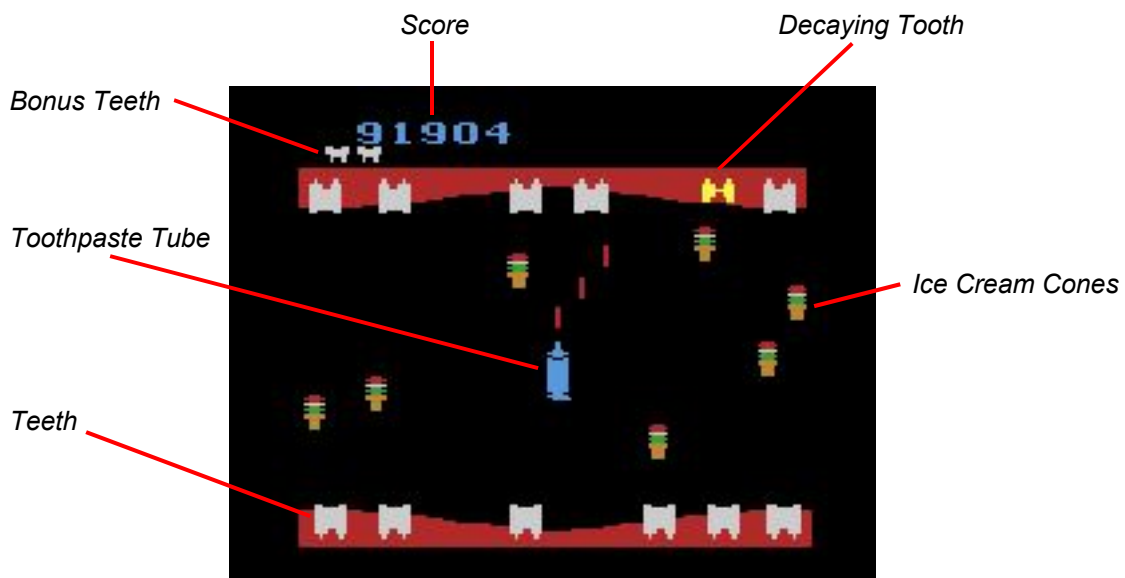

SPECIAL FEATURES OF PLAQUE ATTACK™

Junk Food Cycles. When you've blasted all of the food in all eight of the waves, brace yourself for a super Plaque Attack! All eight waves will return in ferocious retaliation. And the harder **you** work, the harder **they** work, taking on hectic motion patterns and evading your moves with each new cycle.

Limited Time, unlimited shots. There's no limit to the number of shots you can fire. However, your toothpaste tube will shrink as time runs out, and eventually disappear. Careful! Without a tube in your mouth, your teeth are defenseless against the food remaining in that wave.

Dental Restoration. Once plaque attacks a tooth, it turns yellow. But it can still be saved if you act quickly! An immediate blast of toothpaste at the food invader will wipe out the food and plaque and restore your tooth's health and whiteness.

GETTING THE FEEL OF PLAQUE ATTACK™

If you lose all your teeth at first, don't get too down in the mouth. All you need is practice. You'll soon develop a sense of rhythm and timing. Notice that the food waves alternately attack the top and bottom teeth. So, begin to anticipate their movement.

Be generous in your shots of toothpaste. That is, blast away! You've got nothing to lose, since shots are unlimited and time is of the essence.

JOIN THE ACTIVISION® "NO PLAQUE PACK"

Can you reach a score of 35,000 points or more? If so, you will become a "No Plaque Packer", a leader in the bitter war against tooth decay, and we'll give you the official No Plaque Pack emblem.

FIGHTING FOR DENTAL HYGIENE

"Flash! 90% of American mouths are now under plaque attack. Will you be another casualty?"

FACT: Plaque is a bacteria that grows all over your teeth. It uses sugar to form acids that cause tooth decay. Whenever you eat stuff like candy, cakes, sweetened cereals, soda, honey, sweetened juice... you're bathing your teeth with acidic plaque. It's a regular tooth torture test!

Freddie Fluoride™ says – *"You **can** win the war against plaque, just by taking these precautions":*

DENTAL DEFENSE:

1. Cut down on sugary foods! Sure they taste good, but that's just tastebud propaganda. Beneath that sugary coating lies tooth decay. If eaten, avoid panic – remain calm. Brush within 20 minutes.
2. Learn proper brushing techniques and floss daily.
3. See a dentist twice a year for a checkup and a professional cleaning.

"That's all it takes! Won't you give it a try?"

HOW TO JOIN THE NO PLAQUE PACK

Tips from Steve Cartwright, designer of Plaque Attack™.

Steve is one of Activision's most prolific game designers. His previous releases, Barnstorming™, MegaMania™, and SeaQuest™ quickly established his outstanding reputation. Aside from video games, Steve enjoys motorcycle touring, photography, and brushing after every meal.

"Hello there! Let me give you some tips to help you survive the Plaque Attack. It's almost impossible to recover from poor oral hygiene (i.e., sloppy game-play) experienced in the early stages. The best strategy is to acquire as many bonus teeth as possible as soon as you can.

"Next... when things get really hairy, don't bother going after food particles that are not moving towards your teeth. If they're moving off to the side, let them go, concentrating only on defending your teeth from food heading their way. This means playing defensively when the going gets tough. Whereas, in the early stages, it's best to play offensively, blasting away all the junk food in sight.

"Also, remember that the food always reverses direction as soon as a tooth is attacked. Try to save the tooth, then turn your tube around immediately and continue shooting.

"You know, this game is just like real life: Poor tooth care at the start will get you in the end. And the sooner you develop good dental habits, the longer your teeth survive. So put down that junk and write me a letter! Tell me about your system of tooth care – on screen and off!"



COOKING BASICS

Business is booming at "The Grille". Hamburger orders are just pouring in. But back in the Assembly Room, the Food Dispenser is pouring out condiments everywhere. Help Short-Order Sam fill each order with the proper combination of tomatoes, onions, lettuce and cheese. And don't forget the bun! Then, rush the completed orders to the Wrapping Room fast. Alright cooks, grab your spatulas!

1. Please refer to the official manual of *Activision® Anthology* for Game Boy® Advance to review how to setup and select this game.
2. A two-player game requires the use of a second Game Boy® Advance unit connected with a Link Cable. Refer to the official manual for details on how to set this up.
3. Hold the L button and press LEFT to set the music mode. On the **A** setting, the music plays only between waves. On the **B** setting, the music plays continuously. (Note that holding the L button and pressing RIGHT on the D-Pad produces no effect.)
4. **Game Variations.** Hold the L button and press UP on the D-Pad to select a game variation. You have less time to complete each order in the higher game variations.
 - Games 1, 3, 5, 7 – One player.
 - Games 2, 4, 6, 8 – Two players taking turns.
5. **To begin the game,** press the SELECT button.
6. To move Sam up, down, left and right, press the corresponding direction on the D-Pad.

Press and hold the A button down to reject unwanted condiments.

Press the A button to drop completed hamburgers into the wrapping chute.

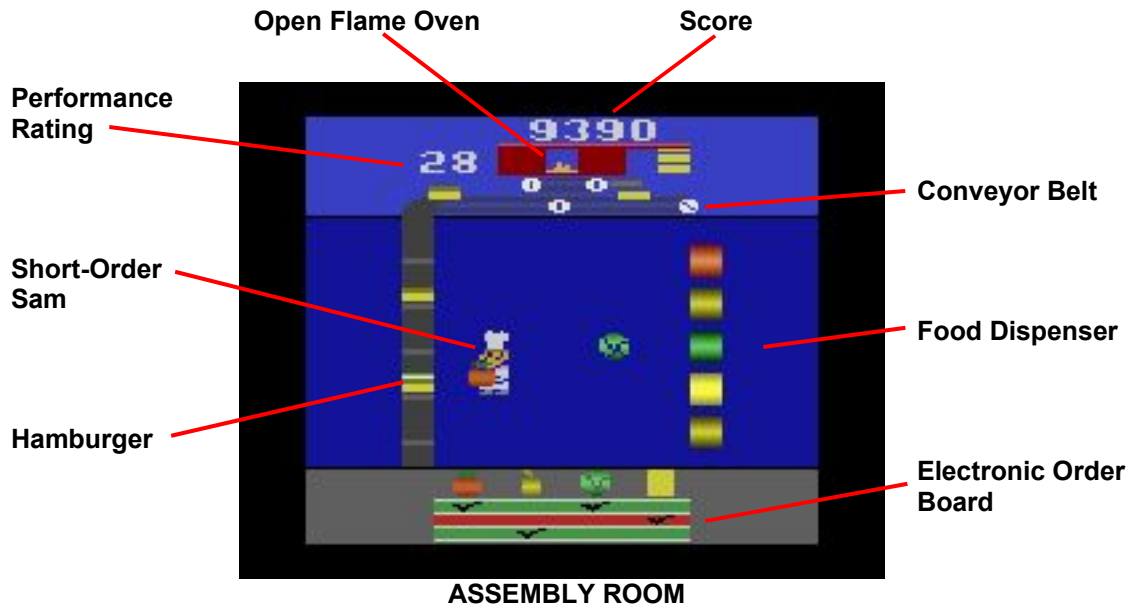

7. **Performance Rating.** You begin with 50 performance points. You can add or lose performance points depending on your efficiency as a cook.

You earn 10 performance points each time:

- Your score increases 10,000 points. The maximum performance rating is 99 points.

You lose 1 performance point each time:

- Any condiment is wasted, smashing against Short-Order Sam or the conveyor belt.
- You place the same type of condiment on any hamburger more than once.

You lose 5 performance points each time:

- You drop a hamburger into the wrong wrapping chute.
- You miss the wrapping chute when you drop the hamburger.

You lose 10 performance points each time:

- A hamburger falls off the end of the conveyor belt.

8. **Scoring.** Each time you catch a condiment you score 5 points. You score 10 points for placing any type of condiment on any hamburger for the first time. 100 points are awarded each time you drop a completed hamburger into the correct wrapping chute. Efficiency Bonus Points and Burger Bonus Points reward you and boost your score at the end of each wave.

9. **End of Game.** The game ends when your Performance Rating drops to zero.

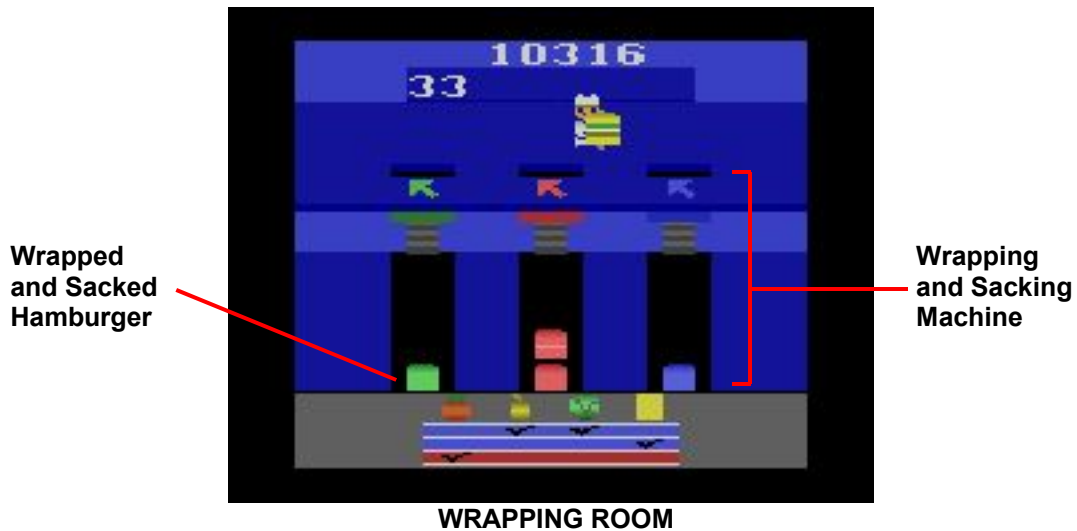

AUTOMATED FOOD SERVICES SILVER KITCHEN

The Automated Food Services Silver Kitchen occupies two rooms in the back of "The Grille". Hamburgers are cooked and orders are filled in the Assembly Room. Completed hamburgers are wrapped and sacked in the Wrapping Room.

ASSEMBLY ROOM

Open-flame oven and conveyor belt. Hamburger patties char broil over the open-flame oven and topples onto the bottom half of a bun. The hamburgers continue along the conveyor belt.

Food Dispenser. Big juicy tomatoes, eight-pound onions, crisp heads of lettuce and squares of cheese fly out of the Food Dispenser one at a time, but hardly ever in the right order. The dispenser throws out the top half of the bun when the proper combination of condiments are placed on a hamburger.

Electronic Order Board. A maximum of three orders appear on the Electronic Order Board at any one time. Each order is color-coded: red, green or blue. A check registers under the condiments needed to fill each order.

WRAPPING ROOM

Wrapping and Sacking Machine. Wrapping and Sacking Machine is equipped with three separate color-coded automatic wrappers. The colors are red, green and blue, corresponding to those on the Electronic Order Board. Completed orders are wrapped and sacked one at a time.

MAKING BETTER BURGERS

Catching ingredients. Flying condiments must collide with Sam's rather rotund stomach – head-on, left or right sides – to be caught. When they hit him anywhere else, splat!

Rejecting ingredients. When you don't want a condiment, press the A button and the condiments will bounce off Sam's stomach. None of the orders ever require any condiment more than once.

Building burgers. Condiments are placed one at a time on the burgers. Touch the burger with the ingredient to place the ingredient on it. When every ingredient needed has been placed on a burger, the color bar on the Electronic Order Board corresponding to that order flashes.

Wrapping burgers. To complete the order, rush Sam to the bottom of the Assembly Room and enter the Wrapping Room. Drop the hamburger into the wrapping chute that is the same color as the flashing bar on the Electronic Order Board.

JOIN ACTIVISION®'S "SHORT-ORDER SQUAD"

Filling orders can really run you ragged, especially at "The Grille". But if you score 45,000 points or more, then we think the cook deserves a round of applause. Stand up and become a bona-fide member of the Activision® "Short-Order Squad": you will receive the special "Short-Order Squad" emblem.

HAMBURGER HERITAGE

Most Americans eat many, many hamburgers each year. But did you know that the name "hamburger" comes from "Hamburg steak" which was a marinated meat dish served in 1801 England? Scholars that study the origins and evolution of food are called Food Historian. Let's see how much you know about the history of the hamburger.

Q. The first hamburger was served in America in what year?

A. In 1900, in New Haven, Connecticut, Louis Lassen served the first hamburger between two slices of toast at his lunch wagon.

Q. When was the first hamburger served between a bun?

A. In 1904, at the Louisiana Purchase Exposition held in St. Louis.

Q. When was the first cheese burger served in America?

A. In Los Angeles in 1929.

Q. Was the Hamburg steak ever prescribed as medicine?

A. The answer is yes. An English doctor named J. H. Salisbury prescribed the "Salisbury Steak" to his patients.

Q. Were hamburgers ever inflated in an attempt to raise the Titanic?

A. The answer is no.

COOKING UNDER PRESSURE

Tips from Garry Kitchen, designer of Pressure Cooker™.

Garry Kitchen is a Senior Designer at Activision. In addition to Pressure Cooker™, Garry designed the best-selling hit, Keystone Kapers™. Garry is a dynamite ping-ponger and, of course, loves to eat hamburgers.

"The Automated Food Services Silver Kitchen waits for no cook. Of course, neither do customers. Here are some tips I use to keep the customers happy and take some pressure off myself.

"First of all, keep moving. The open-flame oven never stops cooking, so you never have time to just stand around. Run to the conveyor belt and place the condiment on the hamburger. After dropping a hamburger into a wrapping chute, hurry back to the Assembly Room. Don't waste time watching the order fall into the sack.

"Also, it is important to remember that the Food Dispenser only throws out one condiment at a time. So, if there is one in particular that you need, then move closer to the dispenser and reject the ones that you don't need. It'll really speed things up, and you'll get the condiment that you need sooner.

"Lastly, there will be times when you catch a condiment that you don't want. When that happens, place it on the hamburger at the top of the conveyor belt and hope the next order will need it. But more importantly, try not to catch any useless condiments.

"When it's closing time at 'The Grille', and all the customers have gone home, drop me a line. I'd love to know how your shift went."

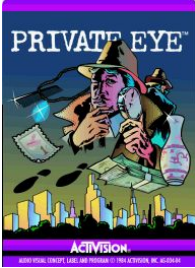

PRIVATE EYE™

by Bob Whitehead

1 player

© 1984 Activision Inc.

"Sacre bleu! I am the great French private eye Pierre Touché and I need your help. I've been summoned to capture the ringleader, Henri Le Fiend, and turn him over to the police. But wait – we first must find evidence against him and the stolen property. There are five cases pending, each with its own statute of limitation. A case is closed when Le Fiend is apprehended and booked. So hurry! Study the files below, grab your trenchcoat and meet me at Precinct 2600 – I'll be waiting for you."

Sleuth wanted! Help Private Eye Touché navigate the city streets, parks, secret passages, dead-ends and one-ways in search of Henri Le Fiend and his gang. Evidence and stolen goods are scattered about – you'll need to find these, too. Let the map and your memory be your guide. And let nothing go unnoticed.

THE "LE FIEND" FILE.

CASE 1: "Safecracker Suite"

On Thursday, Sept. 7, at approximately 1:30 p.m., bankteller Betty Jeepers activated the silent alarm near her foot. The man standing at her window had just handed her a note demanding \$10,000 in one bag. The note also described the loaded gun in his pocket. Jeepers described him as diminutive but suave and said he bowed slightly as he left, saying, "Merci beaucoup." Quickly, Touché looked to the sky and said, "It's him."

PROSECUTION REQUIREMENTS: Find the gun and verify it at the gunstore.
Find the money and return it to the bank.
Find Le Fiend and book him at Police Headquarters.

STATUTE OF LIMITATIONS: 3 minutes
LOCALE: Uptown, 32 blocks

CASE 2: "Closed on Mondays"

"I thought they were the electricians," answered Nimrod Nerdon. Touché had asked the nervous security guard why he let two men enter the museum on an off day and then allowed them to shut off the lights. When they came back on, the men were gone. So was a priceless Ming vase. Nimrod could only remember that the button was missing on one of the perpetrator's cuffs. "Oh... and it was a French cuff," he added. Touché clenched his teeth.

PROSECUTION REQUIREMENTS: Find the button and verify it at the tailor shop.
Find the vase and return it to the museum.
Find Le Fiend and book him at Police Headquarters.

STATUTE OF LIMITATIONS: 2 minutes
LOCALE: Upper midtown, 32 blocks

CASE 3: "Dealing in Diamonds"

Mrs. Lotta Moorcash was beside herself. "But he was such a gentleman!" A man claiming to be her new hair stylist had given Mrs. Moorcash a new hairdo. By the time he'd combed out the last curl, she was oblivious to the four carat diamond necklace that was suddenly absent from her neck. "You must find him!", she said. "It's the best style I've ever had – a French twist!" Touché's daquiri glass shattered in his fist.

PROSECUTION REQUIREMENTS: Find the comb and verify it at the barbershop.
Find the necklace and return it to the gemstore.
Find Le Fiend and book him at Police Headquarters.
STATUTE OF LIMITATIONS: 4 minutes
LOCALE: Midtown, 64 blocks

CASE 4: "Rare Stamp Roulette"

It was the first time Mr. Rich N. Boring had his name in the papers. It was in recognition of his upcoming donation of a valuable rare stamp to the Auxiliary Association of Associated Auxiliaries. Unfortunately, his name was followed by his address. By morning the stamp was gone. From the looks of the footprints on Boring's newly varnished floor, Touché deduced that the thief's sole adhered and came loose. The stamp was described as an 1872 commemorative. "Commemorating what?" asked Touché. "The French Revolution." Touché raised his collar and left immediately.

PROSECUTION REQUIREMENTS: Find the shoe sole and verify it at the shoe store.
Find the stamp and return it to the stampstore.
Find Le Fiend and book him at Police Headquarters.
STATUTE OF LIMITATIONS: 10 minutes
LOCALE: Downtown, 128 blocks

CASE 5: "The Big Sweep"

Touché would take a new approach. Rather than gather the evidence case by case and prosecute Le Fiend four times, he decided to take everything on at once. The whole city, the entire gang, all the cases and, of course, Le Fiend. He rose early that day and took a deep, invigorating breath. "Room service," he said into the phone, "please send up breakfast. What is today's special?" The voice on the other end replied, "French toast."

PROSECUTION REQUIREMENTS: All of the stolen goods and evidence in cases 1–4 must be found and returned for verification at their place of origin. Le Fiend may then be rounded up and booked at Police Headquarters once – and for all.
STATUTE OF LIMITATIONS: 20 minutes
LOCALE: Entire city, 248 blocks

PRIVATE EYE™ BASICS

Please refer to the official manual of *Activision® Anthology* for Game Boy® Advance to review how to setup and select this game.

TO START

Hold the L button and press UP on the D-Pad to choose desired case. The case number appears above the score and its corresponding stolen item appears in the upper right corner. Then press the SELECT button. The statute of limitations begins counting down as soon as you press any direction on the D-Pad.

TOUCHÉ'S AUTO

Upon Touché's arrival, a federal attache will present him with a specially equipped 1935 Model A. Its unique feature is the ability to jump as high as two stories. Additionally, it can make 90° turns and has a cruise control.

USE OF THE CONTROLS

To accelerate left or right, press LEFT or RIGHT on the D-Pad. To drive into an alley or park lane, press UP on the D-Pad.

DIFFICULTY SWITCHES

Hold the L button and press LEFT on the D-Pad to set your car's cruise control; The **A** setting maintains a fast speed, while the **B** setting maintains a slow speed.

Hold the L button and press RIGHT on the D-Pad to set how your car jumps. By setting it to **A**, the height of the jump is controlled by the length of time the A button is held down. Setting it to **B** causes the car to jump to its maximum height with a single press of the A button.

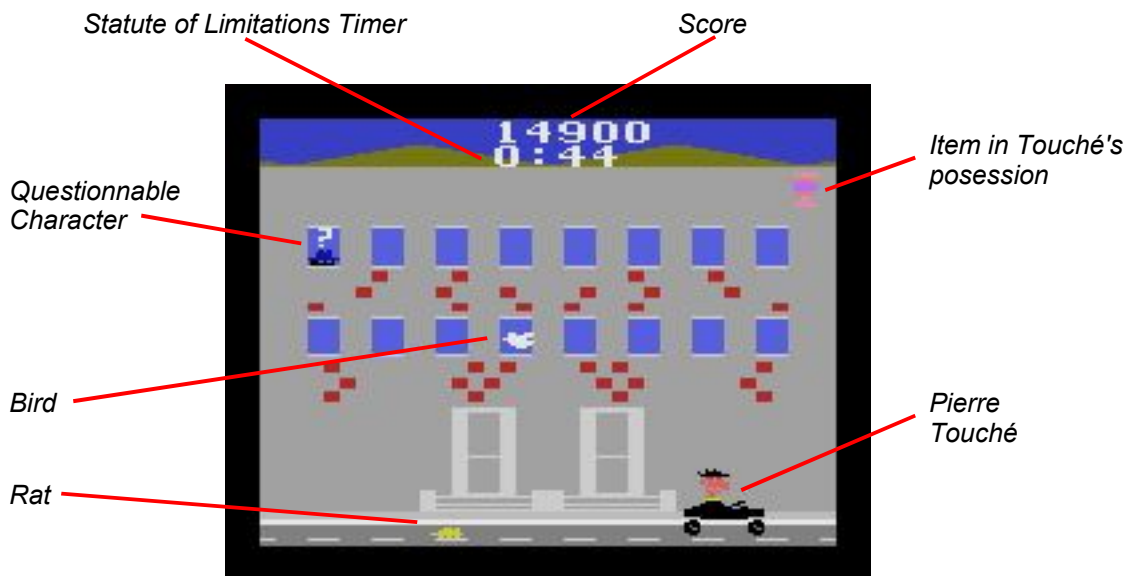

POLICE PROCEDURE

Warrant Requirements – Reasonable cause must be established before Le Fiend can be booked with the police. "Reasonable cause" consists of finding the evidence, verifying it at its place of origin, recovering the stolen property and returning it to its owner. The evidence and stolen item may be found in any order, but you may only carry and return one item at a time.

Proceed with caution: After the first item has been returned, thugs lurch out from behind steps and bushes to throw daggers. Jump to avoid them. If you're hit, the thugs will repossess anything you are carrying.

Questionable Characters – Throughout the case, questionable characters will peek out of windows. Any one of them may be harboring the item you are looking for. Jump up and see! Even if they're empty-handed, you'll still get merit points each time you nab one of them. Finally, if you recover an item while you are carrying another item, the questionable character will make a switch and you will continue with the new item.

The City Beat – Get to know the locations of **detours** and **roadblocks**. Detours are striped; roadblocks are solid yellow. You will also encounter **secret passages, one-ways** and **dead-ends**. Secret passages are short-cuts whereby you enter an alley on one street, and may emerge on a different block, often in a different part of the city! Get to know these short-cuts and map them out. Many offer round-trip passage, but some are one-way only or dead-ends.

POLICE MERIT SYSTEM

Special agents will begin with 1000 merit points – just for taking on the case!

The following system of merits and demerits applies:

DEMERITS

Minus 1	Whenever auto is on a pot hole.
Minus 100	If Touché or his car is hit by a brick.
Minus 200	If hit by a flowerpot.
Minus 300	If hit by a rat.
Minus 400	If hit by a bird.
Minus 1000	If hit by a dagger.

MERITS

Plus 100	For each questionable character nabbed.
Plus 5000	For each questionable character nabbed with evidence (gun, button, comb, shoe sole).
Plus 15,000	For each questionable character nabbed with stolen item (money, vase, necklace, stamp).
Plus 10,000	Whenever evidence is verified.
Plus 20,000	Whenever a stolen item is returned.
Plus 25,000	For nabbing Henri Le Fiend.
Plus 25,000	For booking Le Fiend at Police Headquarters and, thus, closing the case.

SUPER SLEUTH

Super Sleuth is our time-honored enclave of seasoned private eyes who, by serving justice in Case 3, "Dealing in Diamonds" have amply demonstrated their talents in detection. If you have met this criteria, your name will be added to the **Super Sleuth** registry and you will receive its official emblem.

LETTER FROM THE COMMISSIONER

Tips from Bob Whitehead, designer of Private Eye™.

Bob is not only an award-winning, senior designer at Activision, he's also one of its founders! He lives in California with his wife Karron and their four children, and is an avid fan of sports, particularly baseball.

"Well sleuths... I hope you're not looking for any dead giveaways. You've got to figure this one out for yourselves. But here are some clues:

"If you run into a thug's dagger, thereby losing the item you're carrying, all is not lost. You can reclaim the item by retracing your last few blocks. Look for it in a window or by a bush.

"Now here's a riddle for you: What's the difference between a roadblock and a detour (**Besides** the fact that one's yellow and the other one's stripped)? Clue: The answer will have you jumping for joy!

"Try to figure out the best direction to head in when you begin each case. Some cases are easier when you start out to the left, and some are easier when you start out to the right. Also, certain cases "prefer" you to pick up the evidence first, while others are more easily solved when the stolen item is found first. So discover and jot down the "initial direction" and "order of search" for each case.

"Touché! to those of you who will brave Case 5. I feel obligated to say that, although it is the sum of Cases 1–4, some of the secret passages will be changed. But don't let that discourage you. Just adjust your map a bit.

"When you get back to the precinct with Le Fiend, please send a report – it'll be fun to compare notes. Good luck and God bless."

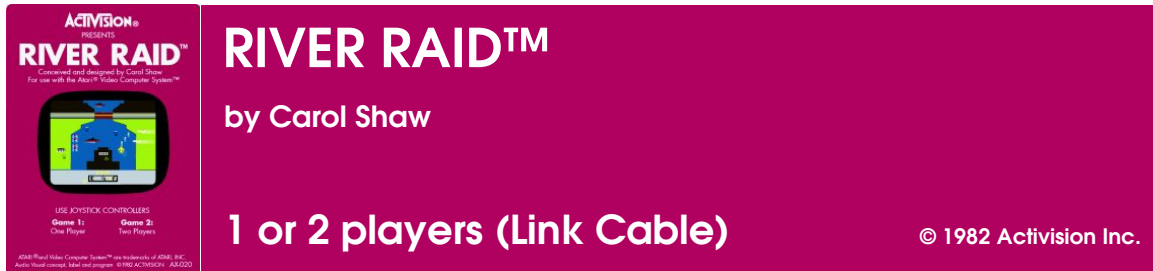





RIVER RAID™ BASICS

Your mission is to score as many points as possible by destroying enemy tankers, helicopters, fuel depots, jets and bridges before your jet crashes or runs out of fuel. Here's how to begin:

1. Please refer to the official manual of *Activision® Anthology* for Game Boy® Advance to review how to setup and select this game.
2. A two-player game requires the use of a second Game Boy® Advance unit connected with a Link Cable. Refer to the official manual for details on how to set this up.
3. **Difficulty Settings.** Hold the L button and press LEFT on the D-Pad to set the difficulty or handicap for player 1. Likewise, hold the L button and press RIGHT on the D-Pad to set the difficulty or handicap for player 2. The effect is the same in both cases:
 - A – (Expert) Missiles streak straight ahead.
 - B – (Novice) "Steer" missiles with the D-Pad.
4. Hold the L button and press UP on the D-Pad to select the number of players:
 - Game 1: One player
 - Game 2: Two players taking turns
5. **To begin or start a new game.** Press the SELECT button. This will bring your jet up to the starter mark. Then press the A button or press any direction on the D-Pad to start the action.
6. Fire missiles by pressing the A button. Hold the A button down for continuous fire. Press LEFT on the D-Pad to bank left, or press RIGHT to bank right. Press UP to accelerate your jet, or press DOWN to slow your jet.
7. **Reinforcements.** You begin each game with a squadron of three jets in reserve. For each 10,000 points you score, you're given an additional jet. You can only have nine reserve jets on the screen at one time.
8. **Fuel.** You have a limited amount of fuel. When you begin to run low, fly over a fuel depot to refuel (See "Fuel Gauge" under "Special Features").

9. **Scoring.** Each time you destroy an enemy object, you score points. The point values for each object are listed below:

River Raid™ Point System

Enemy Object		Point Value
	Tanker	30
	Helicopter	60
	Fuel Depot	80
	Jet	100
	Bridge	500

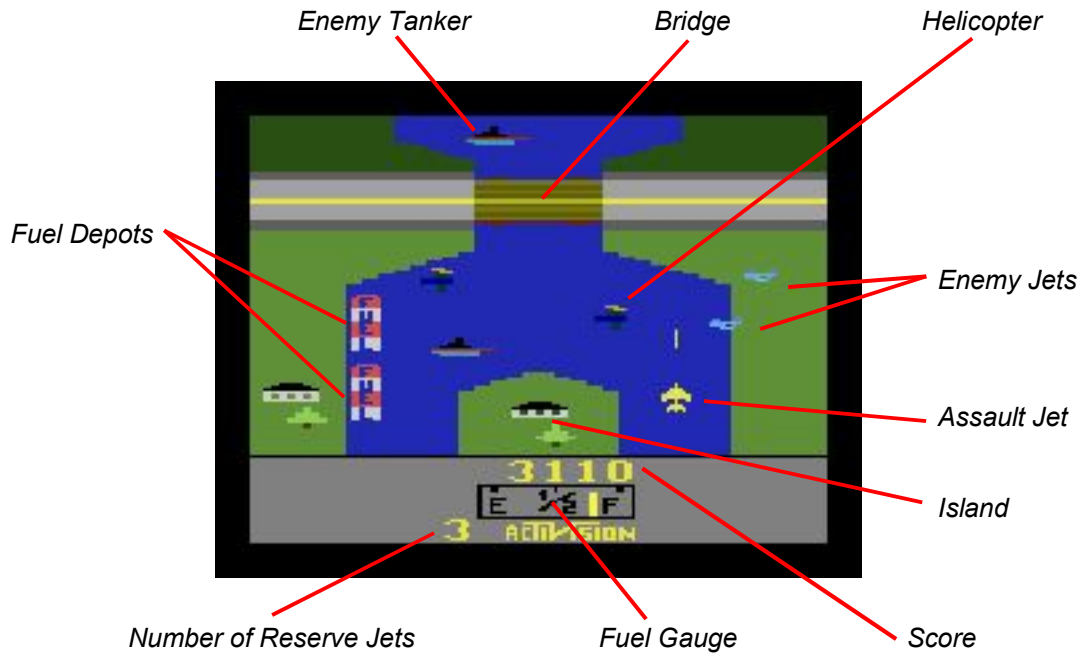

SPECIAL FEATURES OF RIVER RAID™ BY ACTIVISION®

The River of No Return. The river is divided into sections with a bridge at the end of each section. Notice that the river is always changing. You will encounter islands, narrow channels, bays, and lots of enemy ships and aircraft moving to block your path. Also, the farther down the river you fly, the fewer fuel depots you'll find. In some areas, fuel is quite scarce, so you'll really have to move if you want to survive.

Fuel Gauge. Always keep an eye and an ear on your fuel gauge. Fuel is used up at a constant rate, regardless of speed. When your fuel drops below 1/4 full, a warning siren sounds to alert you – it's time to refuel! The slower you fly over a depot, the more fuel you receive. A bell will sound while you are refueling. The sound changes to a higher pitch when your fuel tank is full.

Losing a Jet. You lose a jet when it collides with the river bank or one of the enemy objects (except fuel depots), or when you run out of fuel. If you have a reserve jet left, you restart play at the same section of the river where you crashed. However, if you've managed to destroy the bridge at the end of that section, then you get to restart play at the beginning of the next section.

GETTING THE FEEL OF RIVER RAID™ BY ACTIVISION®

To learn to fly successful missions, you'll need the sensitivity, touch and sharpshooting skills of a precision jet pilot. But that takes time and practice.

At first, try jetting down the river at slow speed. Practice banking your plane, sharpening your aim, and dodging the enemy. To win in this game, you'll have to be just as good at dodging as you are at destroying enemy bridges and aircraft.

Then, accelerate your jet with bursts of speed to see how it reacts to the controls. Since you'll be making split-second decisions, you'll need to know exactly how you and your plane will act in a pressure situation.

HOW TO JOIN THE ACTIVISION® “RIVER RAIDERS”

If you reach a score of 15,000 points or more, you are eligible to become an official River Raider, and we'll give you an official River Raider emblem. Score the maximum one million, and all points on the screen will be replaced with exclamation points.

HOW TO BECOME A RIVER RAIDER

Tips from Carol Shaw, designer of River Raid™

Carol Shaw is one of Activision's newest game designers, but isn't a newcomer to video game design. She's also a scholar in the field of Computer Science.

"The River of No Return holds many special challenges and dangers for would-be River Raiders. You'll not only have to know your assault jet, but you'll need to have a good idea of your basic fight plan before you start.

"By knowing the river, pinpointing areas with the highest concentration of enemy, and the most fuel depots, you'll have a much better chance of surviving. Since the river is in sections, try jotting down notes for each important section as flight aids.

"Fuel is also a critical factor. When you're far up the river, fuel is scarce. So, concentrate on flying to the next fuel depot, and don't try to destroy every object.

"When you become really skilled, you'll find you can actually blow up a fuel depot right in the middle of refueling. That way, you can gain the points and some fuel at the same time.

"Finally, remember that your main targets are the bridges. They're worth the most points. And, please, drop me a note and let me know how you're doing. I'd really like to hear from you!"



OPERATION RIVER RAID

Alone in your F-14 assault jet, you're about to undertake the most explosive mission of your celebrated flying career.

After taking off from a sea-based carrier, you'll tear through the skies above the ocean and streak toward a river delta, where you must destroy an enemy bridge. Once past the delta, you must navigate back to the carrier and safely land. Without stopping for handshakes all around, you'll then set off on a new, more dangerous mission.

This is no contest for amateurs. Once airborne, you'll have to refuel in midair while outmaneuvering enemy fire. If you manage to outfuel these fearless devils by blasting them with missiles or torpedoes, you'll also win points.

If you don't make it, two backup planes will come to your rescue. Your missions will continue until your squadron's name is history.

GETTING STARTED

1. Please refer to the official manual of *Activision® Anthology* for Game Boy® Advance to review how to setup and select this game.
2. A two-player game requires the use of a second Game Boy® Advance unit connected with a Link Cable. Refer to the official manual for details on how to set this up.
3. **Difficulty Settings.** Hold the L button and press LEFT on the D-Pad to set the difficulty or handicap for player 1. Likewise, hold the L button and press RIGHT on the D-Pad to set the difficulty or handicap for player 2. The effect is the same in both cases:
 - A** – (Expert) Missiles streak straight ahead.
 - B** – (Novice) "Steer" missiles with the D-Pad.
4. Hold the L button and press UP on the D-Pad to select a one- or two-player game. The number of players will be displayed at the top of the screen.

Overhead View of River Channel



1. To begin the game, press the SELECT button or the A button. In a two-player game, Player 1 starts the game and takes off first.
2. To take off, press the A button again, holding it down to accelerate down the carrier runway. As you reach the end of the runway, quickly press DOWN on the D-Pad until you're airborne.
3. Once you're airborne, your Thrust bar will be replaced by an altimeter. To increase altitude, press DOWN on the D-Pad. To decrease altitude, press UP on the D-Pad. Increasing your altitude will slow you down; decreasing your altitude will speed you up.

Watch your altimeter. If you fly too low, you'll crash. The altimeter bar flashes red when you're dangerously low. If you fly over land when the altimeter bar is flashing, you'll crash.

The radar screen pinpoints your position throughout your mission and will identify the mission target as a flashing blip.

4. To bank right or left, press RIGHT or LEFT on the D-Pad.

REFUELING IN MIDAIR

To refuel, fly over the gold refueling planes that are flying in your direction. These planes appear only over the ocean, so watch your fuel gauge. At the river, you can refuel by flying at low altitude and picking up the gold buoys floating in the water. A warning sound will tell you when your fuel level is dangerously low. If you run out of fuel, you'll crash.

CONQUERING THE ENEMY

Avoid collisions with enemy helicopters, fighter jets, and flak bursts, or you'll be today's headline.

To fire missiles at helicopters and jets, press the A button. To drop torpedoes on enemy sea vessels, tanks, water towers, landing strips, buildings, or bridges, press the A button while pressing DOWN on the D-Pad.

You cannot destroy enemy flak bursts. Just stay out of their way!

LANDING

When calm seas appear below, your aircraft carrier is close by. The radar screen will display your altitude and proximity to the ship.

1. Press DOWN on the D-Pad to maintain your altitude.
2. Hold down the A button. The Thrust bar replaces the altimeter. Increase your thrust until you reach the aircraft carrier.
3. As soon as you're over the carrier, release the A button and quickly press UP to land.

YOUR F-14 ASSAULT JET SQUADRON

The backup jets in your squadron will take over if you crash, run out of fuel, or are hit by the enemy. Whenever a new plane steps in, it will continue the mission at the position where the last plane was destroyed. Backup planes always begin with a full fuel tank and at the highest altitude.

THE END OF THE MISSION

The game ends if you lose all three planes or you successfully destroy the enemy target and land on the aircraft carrier. At this point you can start a new game or continue the game with a new, more difficult mission. Each new game or mission begins back on the carrier.

RIVER RAID II FLYING TIPS

- Try to enter the river channel with a full tank of fuel. Fuel is tough to come by at the river scene.
- Maintain a low altitude when flying over the river. It's easier to swoop down and pick up fuel buoys.
- Keep a close eye on your radar to locate your mission target.

SCORING

In a two-player game, Player 1's score is displayed in white and Player 2's score is in black.

Enemy Object	Point Value
Fighter Jet	100
Helicopter	150
Destroyer	200
Carrier	250
Water Tower	300
Building	400
Landing Strip	500
Tank	600
Bridge	2500



FROM THE OFFICE OF THE PRESIDENT

Greetings. As you well know, sophisticated enemy Robot Tanks are quickly advancing cross country, firing at will and stopping at nothing. You must command your own Robot Tanks to stop their charge of chaos. Avoid being hit by enemy fire, or your Robot Tanks may be destroyed. The rebels are currently headed towards downtown Santa Clara. Only you can stop them.

Good luck!

GAMEPLAY

1. Please refer to the official manual of *Activision® Anthology* for Game Boy® Advance to review how to setup and select this game.
2. The difficulty and game select switches are not used. In other words, holding the L button and pressing either LEFT, RIGHT or UP on the D-Pad produces no effect.
3. **To begin play**, press the SELECT button.
4. **How to Play.**
 - Press LEFT on D-Pad to maneuver and/or aim your Robot Tank left.
 - Press RIGHT on D-Pad to maneuver and/or aim your Robot Tank right.
 - Press UP on D-Pad to roll your Robot Tank forward.
 - Press DOWN on D-Pad to retreat.
 - Press the A button to shoot your Robot Tank cannon at rampaging enemy Robot Tanks. Hold the A button down for continuous fire.
5. **Scoring.** A small tank appears at the top of your screen for each enemy Robot Tank you destroy. A square with the number 12 appears at the top of your screen each time a squadron of twelve enemy Robot Tanks are destroyed.

6. **Reinforcements.** You begin with one active Robot Tank and three reserves. Reserve Robot Tanks begin operation in perfect condition. You earn one bonus Robot Tank for every enemy squadron destroyed. The maximum number of bonus Robot Tanks allowed at any one time is 12.
7. **End of Game.** You may lose your Robot Tank when it is hit by enemy rocket fire. Your video scrambles with static interference when this happens. Some hits may only damage your tank. (See "Damage Sensors" in "Special Features"). Game ends when all of your Robot Tanks are destroyed or all 12 enemy squadrons are destroyed.

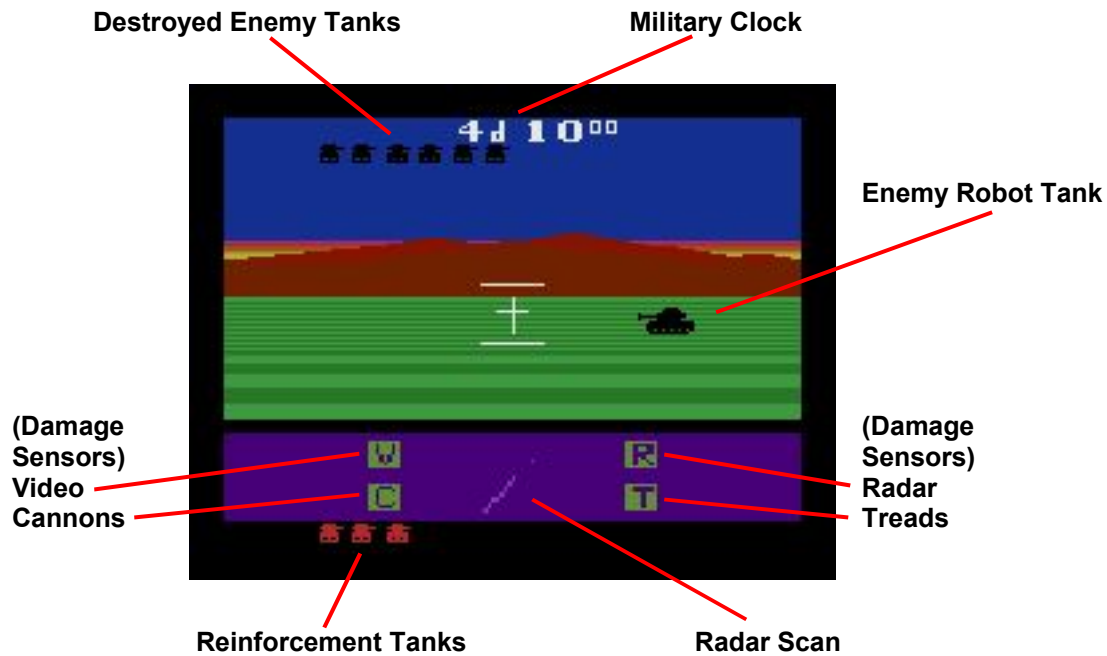

SPECIAL FEATURES OF ROBOT TANK™

Your Electronic Eye. Your Robot Tank's electronic eye lets you view the battlefield from a remote control station. Perspectives are real. The size of enemy Robot Tanks and their fire increase on your remote screen as they get dangerously close.

Twenty-four hours in a day. From the first glimmer of sunrise, beyond the grey dusk and into darkened night, the enemy attacks relentlessly. For you, sleep becomes a distant memory. The military clock counts the hours and the days and can be used as a tool for strategy (see "Tips from Alan Miller"). How long can you go on?

Weather Alert. Fog, rain and snow are reported to you through pre-dawn computer updates. In the snow, your tank will slip and slide. Rain significantly impedes your tank's mobility. In blanketing fog, enemy Robot Tanks are only visible when they are right in front of you. So, take advantage of bright sunshine while it lasts.

Radar Scan. The circular radar scan at the bottom of your screen is your window on the entire battlefield. Your tank is at the center of the scan, and the moving dot describes location, distance and directional movement of the enemy Robot Tank. Enemy tanks only fire rockets when they are in **front** of your tank. Your tank is safe when the enemy tank is behind you – when the moving dot is **below** the center of the scan.

Damage sensors. Video, cannons, radar and treads can be damaged by an enemy hit. Sensors report the damage by flashing on your control panel:



Video, your view on the battlefield, blacks out periodically.



Cannons will never go completely out, but when damaged, don't count on them firing all the time.



Radar scan inoperative. You must depend on your video to fix enemy position.



Treads damaged. Mobility is brought to a crawl. Movement is almost entirely frozen in the snow.

Be forewarned! Damaged tanks can NEVER be repaired.

Guiding your cannon fire. Your tank's cannon fire is continuously targetable while it's in-flight. It will follow the direction of your cross hairs. Also, enemy rocket fire can be prematurely detonated by intercepting it with your own cannon fire. Destroying an enemy Robot Tank automatically explodes its in-flight rockets.

GETTING A READING ON YOUR ROBOT TANK™

To successfully stop the rampage of enemy Robot Tanks, you must first become completely at ease with your own machine. There will be enough tension in the throes of battle.

Start out by practicing simple maneuvers. Roll your tank in all directions – forward, back, left and right. Pay strict attention to your tank's speed. It is important to know how quickly it can advance on enemy Robot Tanks or retreat from them.

Dodging enemy fire is a vital defensive move. Find out how close you can get to an enemy Robot Tank and still have time to avoid on-coming rocket fire.

The radar scanner is a very important monitoring device. It is the only **consistent** way to know where the enemy is located at night or in unforgiving fog. Practice using the scanner by firing your cannon when an enemy tank is directly above the center. It's the only time you can make a hit.

HOW TO JOIN ACTIVISION'S TANK CORPS

For service beyond the call of duty, you are eligible to join Activision's Tank Corps. If you destroy at least 48 enemy Robot Tanks (4 squadrons), then you've earned the Medal of Merit patch. Succeed in destroying 60 enemy Robot Tanks (5 squadrons), and you proudly deserve the Cross of Excellence patch. Distinguish yourself by destroying 72 enemy Robot Tanks (6 squadrons), and your meritorious achievement decorates you with the Star of Honor patch.

SPOTTING NEEDLES IN A HAYSTACK... 5000 MILES AWAY

The United States has the most complex, exact and efficient defensive surveillance system of any country on Earth. This is due, in part, to an elaborate use of computers.

Deep inside hollowed-out Cheyenne Mountain, directly west of Colorado Springs, Colorado, is an expansive bank of computers and security surveillance screens. These computers receive information from strategically positioned radar stations located all over the Earth. The name of this Defense Command Center is NORAD, which stands for North American Air Defense Command.

NORAD's high-powered radar antennas continually scan the skies to detect all aerial movement and transmit relevant data to the computer center in Colorado. Many of the antennas have a 3000 mile scanning range capability, and some of the biggest antennas can detect an object as small as a bouncing basketball 5000 miles away, just about the distance from New York to Honolulu.

The computers evaluate the data to determine the size, shape, direction and speed of the moving objects. The data transmitted by the antennas is so detailed that the computers can even describe such physical features as what material the moving object is made of.

BECOME A HIGHLY DECORATED VETERAN OF ROBOT TANK™

Tips from Alan Miller, designer of Robot Tank™.

Alan Miller is an award-winning senior designer at Activision®. One of the "giants" in the field, he's created Checkers, Tennis, Ice Hockey, StarMaster™ and now, Robot Tank™.

"Once you're locked in electronic battle, there's only one thing you can be sure of – nothing ever stays the same.

"Enemy Robot Tanks continually sneak up on you. You'll frequently end up losing visibility for one reason or another. So, practice aiming at enemy tanks using **only** the radar scan. If you can master this, you will have better battling success at night or in fog.

"When there's no visibility, I suggest constantly maneuvering your Robot Tank to keep the enemy behind you, so that the vulnerable front of your tank is safe. Then, you can wait until conditions improve.

"If your tank is damaged, and it's night, keep track of the time using the military clock. If it's close to 0500 hours, then you may decide to wait for the weather alert. Conditions may improve from the previous day, and your next offensive may prove more successful.

"Remember that you can neutralize enemy fire by shooting into it. But, it's a risky tactic. Your miss could backfire and become a hit for your attacker.

"P.S. When you've put plenty of distance between your Robot Tanks and the enemy, and all robotic communication has normalized, issue me a battle report. I'd love to know how you and your machines are doing."

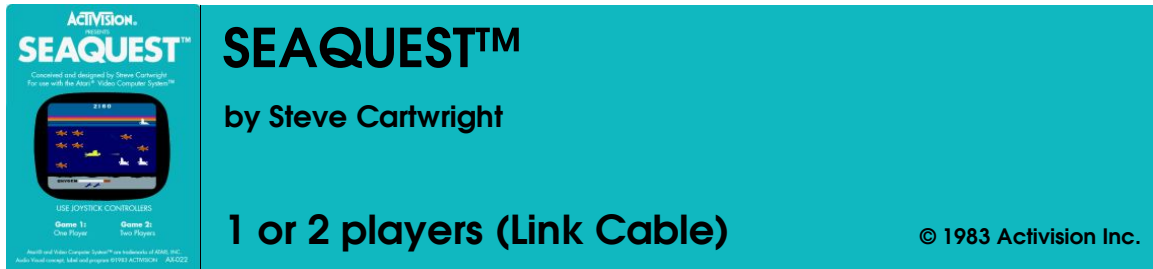

SEAQUEST™ BASICS

Your divers have retrieved the buried treasure, and now you must come to their rescue. The object of Seaquest™ is to retrieve as many treasure-divers as you can, while dodging and blasting enemy subs and killer sharks. All before your oxygen runs out!

1. Please refer to the official manual of *Activision® Anthology* for Game Boy® Advance to review how to setup and select this game.
2. A two-player game requires the use of a second Game Boy® Advance unit connected with a Link Cable. Refer to the official manual for details on how to set this up.
3. Holding the L button and pressing LEFT on the D-Pad will allow you to set the continuous firing rate of player 1's sub. Likewise, hold the L button and press RIGHT on the D-Pad to set the continuous firing rate of player 2's sub. In both cases, setting the firing rate to **B** will cause fast continuous fire from your sub when you hold down the A button. Set the firing rate to **A** for slower continuous fire.
4. Hold the L button and press UP on the D-Pad to select the number of players:
Game 1: One player
Game 2: Two players taking turns
5. **To start**, press the SELECT button. This will position your sub on the waves, place three reserver subs on the horizon and fill your oxygen tank. The action begins as soon as you submerge.
6. Press the A button to fire torpedoes, hold it down for continuous fire. Press DOWN on the D-Pad and you'll submerge; press UP and you will ascend. Tap LEFT or RIGHT on the D-Pad to face your sub to the left or to the right. Hold LEFT or RIGHT to move your sub in that direction.
7. **Rescue divers** by cruising into them with your sub. As soon as you have retrieved your sixth diver, you'll hear a quick beep. Now surface and listen to six gold ingots, worth valuable points, plunk onto your deck (see "Scoring").
8. **Scoring.** When the game begins, every killer shark and enemy sub is worth 20 points. Every time you surface with six divers, the value of enemy subs and killer sharks increases by 10, up to a maximum of 90 points each. Rescued divers start at 50 points each. Then, their point value increases by 50, every time you surface, up to a maximum of 1000 points each. Also, you'll be further rewarded with bonus points for all the oxygen you have remaining the moment you surface. The more oxygen you have left, the more bonus points you're given.

SPECIAL FEATURES OF SEAQUEST™ BY ACTIVISION®

Your Oxygen Gauge is at the bottom of the screen. Whenever your sub is underwater you'll be using up oxygen at a constant rate. When the oxygen tank is almost empty, a continuous beep alarm will sound and the alarm light will flash. You have 8 seconds to surface for air! If you don't surface in time, your sub will blow up and you'll lose one diver. Each time you're forced to surface, with less than six divers, you lose one diver. And, if you surface with no divers on board, you'll lose your sub.

Killer Sharks and Enemy Subs are deadly. If your sub collides with anything except your own divers, your sub will explode. And, the longer you're out in the ocean, the rougher the seas become. So after each round, take a breath – enemy subs and sharks will increase in speed.

The Enemy Patrol Sub will appear on the surface when you've rescued your second group of six divers. Avoid it. If you collide, your sub will explode, and you'll lose one diver. While you are refilling your oxygen tank, the Patrol Sub will move in on you. Your sub cannot move away until its oxygen tank is full. So when you surface, do so as far from the Patrol Sub as possible!

You Have Reinforcement Submarines. You start the game with four subs in your fleet – one ready at sea-level and three waiting on the horizon. Each time you increase your score by 10,000 points, an extra sub will be delivered to your base. You can only have six reserve subs on the screen at one time.

GETTING THE FEEL OF SEAQUEST™ BY ACTIVISION®

Mastering the movement of your submarine will be your first and most important duty. Be careful not to oversteer! "Steady as she goes" is a good rule for beginners. Also, practice "Silent Running" – navigating your sub around sharks and enemy subs without firing. It takes skill to learn this technique, but remember: your real mission is to rescue divers – they're worth the most points!

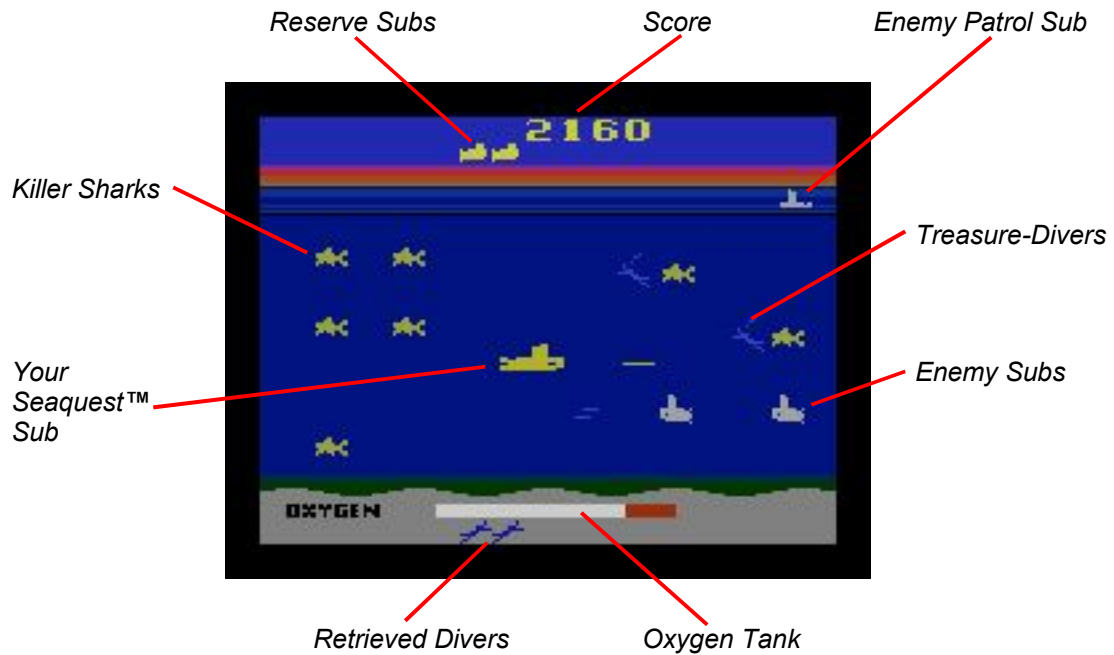

JOIN THE ACTIVISION® "SUB CLUB"

Once your sea legs are steady, you can propel yourself into the "Sub Club." Reach a score of 50,000 points (or more) and you'll be eligible to join this prestigious organization: We'll present you with an official "Sub Club" emblem.

HOW TO JOIN THE SEAQUEST™ “SUB CLUB”

Tips from Steve Cartwright, designer of Seaquest™.

Steve Cartwright is a Senior Designer of Activision®. Before creating Seaquest™, Steve designed Barnstorming™ and MegaMania™ for Activision.

"As you'll quickly discover, you can't join the Sub Club overnight. It takes confidence, sharp aim, and lots of practice. Also, here are a couple of important pointers that should help.

"As soon as you've picked up your sixth diver, start watching out for the Patrol Sub. It's important to surface in the right spot, especially since the Patrol Sub sails faster as the game progresses.

"And, every time you surface, you increase the game's level of difficulty. So, keep your surfacing to a minimum, with one exception: when you've got five divers aboard, and your oxygen's running low – surface to refill your oxygen supply. You'll lose one diver, but you can easily pick up two or more to resurface and gain a lot of extra bonus points.

"Practice 'Silent Running'. It's the best technique I know of to really learn underwater navigation.

"And, next time you return to shore, drop me a note. I'd love to hear your tall tales from the high seas."

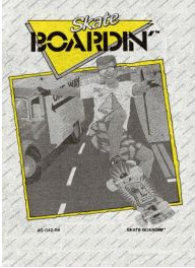

SKATE BOARDIN'TM

1 player

© 1987, 2002 Skyworks Technologies Inc.

"Jump on that board and get psyched for a totally intense cruise!..."

TO BEGIN

- 1) Please refer to the official manual of *Activision® Anthology* for Game Boy® Advance to review how to setup and select this game.
- 2) Press the SELECT button to begin the game. (At any point during the game, press SELECT to begin again.)

Note: The difficulty and game select switches are not used in this game. In other words, holding the L button and pressing any direction on the D-Pad will produce no effect.

THE CRUISE

You *know* you're late for school, but what you *don't* know is that just overnight, an array of obstacles has been placed along the way. **Radical man**, this is a skateboarder's dream come true! You have to get to school on time, but passing up the chance to ride ramps or cruise tubes would make you look like a real nerd! You've got to conquer a total of thirty tubes and ramps in under five minutes to be totally awesome. Not only that, after you find all the tubes and ramps you have to find the front steps of the school building. Check the ratings at the end of the instructions to find out how radical you are.



Your time clock is displayed at the top left of the screen, and next to the clock is a number representing the amount of tubes and ramps you have remaining. Other obstacles include walls, rails and hurdles, **but you need only conquer the tubes and ramps to finish.** The others, however, must be avoided as they will stop you and knock you off your board.

You start at the steps of your house, holding your skateboard. Press the SELECT button to begin. You can walk by pressing any direction on the D-Pad, but that's not going to get you to school very fast. Instead, press LEFT or RIGHT on the D-Pad, and press the A button to jump onto your board. Once on your board, **press the A button to jump or press it and hold it down to crouch.** If the button is held down, you will land into a crouch after the jump.

As you set your course through this gnarly maze, keep in mind that the scoreboard display is not a wall. If you choose to go up, you can cruise right on through. You can cruise through the walks or over the turf area, but cutting across the turf will slow you down. To regain your speed, you must either stay on the turf long enough to stop, or run into an obstacle. This will bring you off your board so you can jump back on and resume at normal speed.

To ride a ramp, you can be in either standing or crouched position – just make sure you are cruising within the area from the bottom to the top of the ramp. In other words, don't try to hit the ramp below or above it or it won't count. A **bing** sound will indicate a successful ramp jump.

To clear a tube, you must travel through it while in a crouch. Head in the direction of the tube, align yourself with the opening and then crouch by jumping and keeping the A button down. While in a crouch, if you need to adjust your position, **tap UP or DOWN** on the D-Pad to fine tune. If you are approaching the tube while standing, or if you miss the opening, you will crash into it and stop. A **bong** sound will indicate a successful pass.



TIPS FROM THE PROS

Remember, each obstacle must be conquered only once. Try to improve upon your time by checking out new shortcuts.

If you want to max out your speed, get yourself up to the street (at the very top of the maze) and try to catch the truck when it passes the stop sign. If you miss it, get off of your board and position yourself with just your feet on the sidewalk. When it passes, it will pick you up and take you for a ride down the street. Get off by pressing any direction on the D-Pad, but watch out – now you're really *cruising*!

You know you're close to the school when you find the schoolyard. If you get really stuck in the maze, try making a map.

There are rumors of a truly radical skateboarder who finished all thirty obstacles and got to school with more than 2 minutes left. See if you can top that!

RATINGS

Number of Obstacles Left	Rating
30–25	Spaz
24–20	Nerd
19–10	Cool
9–1	Radical
0	Totally awesome

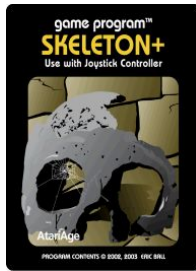

SKELETON+

Homebrew game by Eric Ball

1 player

© 2002, 2003 Eric Ball

STORY

"You are in a maze of twisty passages, all alike" certainly describes the situation you are in.

You hear faint footsteps, so you follow the sound through the maze. To your horror, you discover the source of the footsteps is a Skeleton; and it doesn't look friendly. Acting quickly, you blast it with your Undead Disintegrator and the Skeleton vanishes in a flash of colour. But as you reload your UD, you hear footsteps again; and you wonder; are you the hunter or the hunted in this nightmare?

GAMEPLAY

The objective of Skeleton+ is to eliminate 80 Skeletons without being killed yourself. Use the D-Pad to maneuver your way through the maze. Press the A button to shoot your Undead Disintegrator at a Skeleton. When a Skeleton is destroyed, another will take its place. Destroy ten Skeletons and you will enter the next maze. Complete all eight mazes to win your freedom. Being touched or touching a Skeleton will reduce your life. When your life reaches zero, the game is over.

Each new Skeleton is stronger than the previous and will require more hits from your Undead Disintegrator to be destroyed. You are also not a dead shot with the Undead Disintegrator so sometimes a Skeleton will require more shots to be destroyed. Although each new Skeleton starts moving slowly, the speed with which the Skeleton moves will gradually increase until it is destroyed.

Sound can provide assistance when playing Skeleton+. The sound of the Skeleton's footsteps will get louder the closer the Skeleton is to you. The sound will also be louder if the Skeleton is in front of you and quieter if the Skeleton is behind you. If you're wearing headphones, you will be able to hear if the Skeleton is to the right or left of you as well.

Two numbers are displayed at the bottom of the screen. The number of Skeletons you have destroyed is shown on the left. The amount of life you have remaining is shown on the right.



CONSOLE CONTROLS

Please refer to the official manual of *Activision® Anthology* for Game Boy® Advance to review how to setup and select this game.

To start the game, press the SELECT button, or hold the L button and press UP on the D-Pad. Doing either during the game has no effect.

When the LEFT DIFFICULTY switch is set to **B**, a square will appear at the edge of the screen indicating the direction the Skeleton is in. The square will be near the top of the screen when the Skeleton is ahead of you and near the bottom of the screen when the Skeleton is behind you. To toggle this "Skeleton Locator" on or off, hold the L button and press LEFT on the D-Pad.

Holding the L button and pressing any other direction on the D-Pad produces no effect.

USING THE CONTROLLER

Press UP on the D-Pad to move forward, press RIGHT to turn right and press LEFT to turn left. You must let go of the D-Pad between each move. (*Note: You cannot walk backwards in this game!*)

Press the A button to shoot your Undead Disintegrator. You must release the A button to shoot again. It takes one second for your Undead Disintegrator to reload.

LEGAL STUFF

Permission is granted to distribute the ROM code for the ATARI Video Computer System Game Program, Skeleton+, provided that these instructions are included with the code. Skeleton+ may be included on websites and shareware or freeware compilations, but please contact Eric Ball first.

The end user is granted permission to use the ROM code with an emulator, or a RAM cartridge such as a Supercharger or Cuttle Cart, or to make a single cartridge for use with their ATARI Video Computer System.

Permission is NOT granted for any individual to manufacture or distribute cartridge versions of the ROM code for another end user without the written consent of Eric Ball.

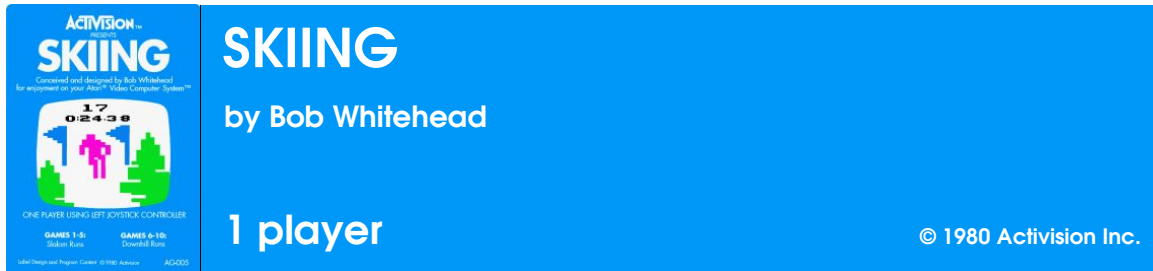

Now you can ski all year long without worrying about tight boots, cold hands, long lift lines – or whether it snows! Skiing by ACTIVISION® challenges you with a wide variety of slalom and downhill runs, designed for everyone from amateur to pro. Even if you've never been on a pair of skis, you can be a champion skier with Skiing by ACTIVISION®. Read these instructions to find out how to make record-breaking runs without getting wrapped around a tree or crashing into a gate.

SKIING BASICS

1. Please refer to the official manual of *Activision® Anthology* for Game Boy® Advance to review how to setup and select this game.

NOTE: The effects of the difficulty switches are explained later in this manual. It is therefore recommended to read this entire manual before playing.

2. Hold the L button and press UP on the D-Pad to select a game:

Slalom Runs

- Game 1: 20 gates, Novice run
- Game 2: 40 gates, Intermediate run
- Game 3: 30 gates, Expert run
- Game 4: 50 gates, Olympic run
- Game 5: 30 gates, a new Expert run every time you select Game 5

Downhill Runs

- Game 6: 200 meters, Novice hill
- Game 7: 300 meters, Intermediate hill
- Game 8: 500 meters, Expert hill
- Game 9: 900 meters, Olympic hill
- Game 10: A new 900-meter Olympic hill every time you select Game 10

NOTE: The hills and courses for Games 1–4 and 6–9 are permanently set. Each tree, gate and mogul is in the same place every time you ski these runs. Whenever you select Game 5 or 10, however, you get a **new course each time**. The course will remain the same for as many runs as you want to take **until you select another game or exit the game**. When you return to Game 5 or 10 again, you'll face a new run and a new challenge.

3. Press the SELECT button to place skier at the top of the hill. The timer will reset to 0.
4. To start skier, press any direction on the D-Pad.

5. The D-Pad controls the position of your skis. Press LEFT and your ski tips will move to the left; press RIGHT and your ski tips will move to the right. The longer you hold either LEFT or RIGHT, the farther your skis will go, until they reach horizontal (you can't ski uphill!). Your skier will go in the direction your skis are pointed and will reach maximum downhill speed when the skis are pointed directly downhill. (See diagram of ski positions.)

SPECIAL FEATURES OF SLALOM RACING

Object: To run through all gates (between the poles) in the fastest time.

Scoring: Elapsed time on timer. You are penalized five seconds for each gate you miss. At the end of each run, the number of gates you missed and your total time (including penalties, if any) are shown on the screen.

If you hit a gate or a tree, do not lose heart: Your skier will jump back up and keep going. But you do lose time, so be careful!

The A button is not used in slalom racing, but can be used instead of the SELECT button to reset your skier at the top of the course. **Don't press the A button unless you want to start over.**

To make a run tougher, set the right difficulty switch to **A** (by holding the L Button and pressing RIGHT on the D-Pad). Now trees will appear on the slalom course in front of the gates (not just off to the side), so you'll really have to be quick to dodge them and still make all the gates.

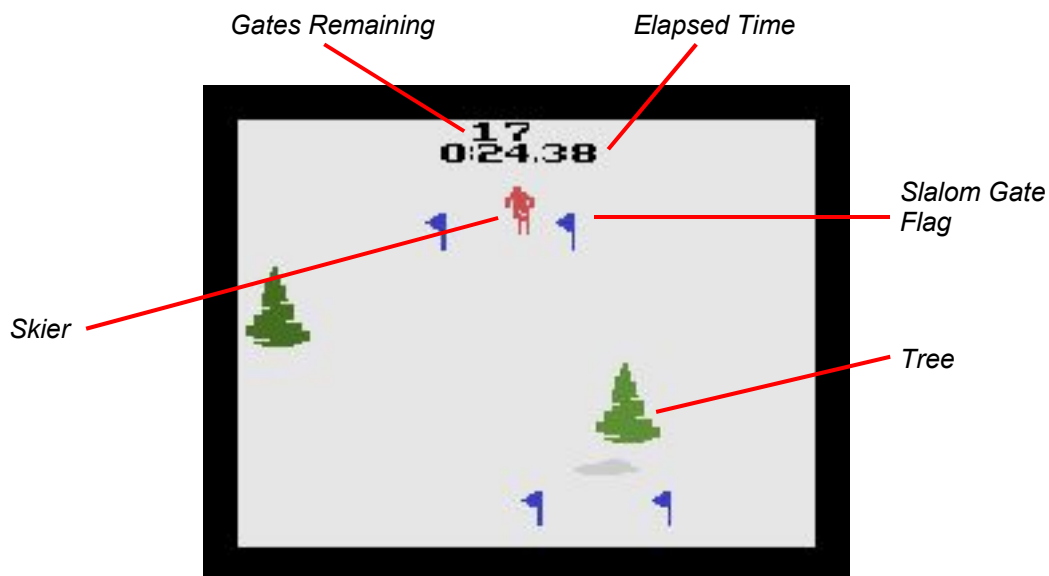

SPECIAL FEATURES OF DOWNHILL RACING

Object: To reach the bottom of the hill in the fastest time.

Scoring: Elapsed time at the end of the run. During the run, the number of meters remaining is shown above the elapsed time.

Penalties: None. But if you hit a tree or fall on a mogul (see below), you'll lose time.

The A button is only used when your right difficulty switch is on the A setting. Then you must push the A button to make your skier jump any moguls in your path (they are the grey patches in the snow). The timing of your jumps is critical; if you're off, your skier will hit the mogul and fall on his face. If trying to dodge trees and jump moguls gets a bit too tricky, just set your right difficulty switch to **B** (hold the L button and press RIGHT on the D-Pad) and your skier will jump each mogul automatically.

Note: You must push the SELECT button to start at the top of the hill on downhill runs.

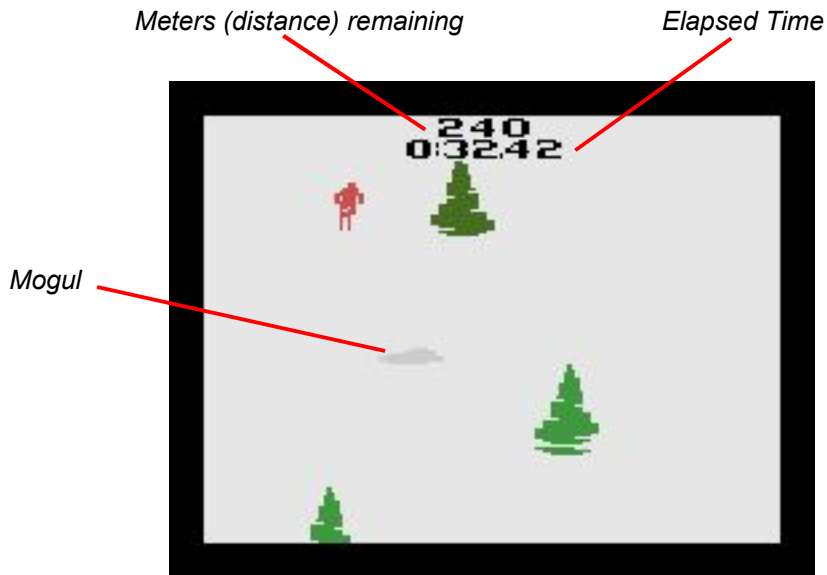

ABOUT THE LEFT DIFFICULTY SWITCH

With the left difficulty switch in the **B** position, the ski run passes by vertically but does not change horizontally, so your skier cannot ski off the course. When he reaches the edge, he stops moving horizontally.

With the left difficulty switch in the **A** position, you can direct your skier off the trail and through the woods – even ski all the way around the mountain, if you wish. We suggest you try this option on **downhill runs only (Games 6–10)**, as an interesting and creative variation on the normal ski run.

GETTING THE FEEL OF SKIING BY ACTIVISION®

Once you know the basics of Skiing, we suggest you get the feel of your controls by skiing on the slow slopes first (Games 1, 2 and 6). Start with both the left and right difficulty switches in the **B** position while you're learning. Gradually tap LEFT and RIGHT on the D-Pad to move slowly across and down the hill, through the trees and gates. See how your skis respond to your D-Pad movements and how changing ski positions changes your skier's direction and speed. You will go fastest when your skis are pointed straight downhill and you'll slow down when you are moving at an angle. You can stop your skier in mid-hill by moving your skis all the way to horizontal.

When you're ready for more advanced challenges, try the faster runs. You'll get faster times, but watch out! The slope is steeper and the gates, trees and moguls come flying at you. And when you're really a hot shot, set your right difficulty switch to the **A** position to push your skills to the limit.

HOW TO BECOME AN EXPERT AT SKIING BY ACTIVISION®

Tips from Bob Whitehead, designer of Skiing.

Bob Whitehead, well known for his fast-action, excitement-packed video games, also designed Boxing by ACTIVISION®.

"The keys to success in Skiing by ACTIVISION®, just as in real skiing, are learning to control the tips of your skis and anticipating and avoiding trouble.

"Keep your skis pointed as straight down the hill as possible. The less you traverse across the slope, the faster you'll make it to the bottom.

"Pick your line through the trees and gates by constantly looking ahead of your position toward the bottom of the screen. When you see the next set of trees and/or gates, point your skis to miss the trees or pass through the gates. Of course, the more you ski any particular hill, the more familiar with it you will become. To get the fastest times, you must memorize the run and ski the shortest possible route down the hill or through the gates.

"When you want to maneuver, I suggest you **tap your D-Pad lightly** to the right or left to move your skis or change direction, rather than pressing heavily on the D-Pad. There are 8 different positions for your skis (see my diagram below) and 15 different directions you can go (downhill plus two possible angles for each left or right ski position).

"We're organizing an Activision® Ski Team. To qualify, you must run slalom course 3 (Game 3) in under 28.2 seconds. If you break that time, we will enroll you as a member and you'll receive our emblem. And if you break 28 seconds, consider yourself Olympic caliber.

"Of course, not everyone wants to ski down a hill in record time. Some of you may just like to ski back and forth and down the hill at your own pace. Go ahead, if you wish.

"I really had a great time working on Skiing by ACTIVISION®. I hope you enjoy playing it as much as I enjoyed designing it. Have fun and God bless!"



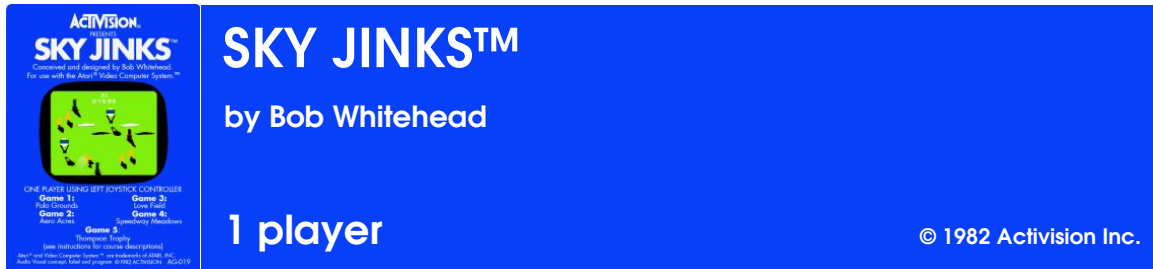

Pre-flight jitters? Air sickness? Dumont got you edgy? Settle down. You'll do just fine. But, please read this manual before takeoff. It'll help put your nerves on autopilot, and give you some real pointers on piloting to victory and the coveted Thompson Trophy.

SKY JINKS™ BASICS

The object of Sky Jinks is to race your P41 through the pylon course, in the shortest possible time, without hitting pylons, trees, or balloonists.

1. Please refer to the official manual of *Activision® Anthology* for Game Boy® Advance to review how to setup and select this game.
2. **Difficulty Switches.** Hold the L button and press LEFT on the D-Pad to set the difficulty of the game. In the **A** position, trees are randomly placed directly in your flight path along the course. In the **B** position, trees are removed from the direct flight path.
3. **Game Select.** Hold the L button and press UP on the D-Pad to select a game:

Game 1: Polo Grounds	(25 pylon course)
Game 2: Aero Race	(50 pylon course)
Game 3: Love Field	(75 pylon course)
Game 4: Speedway Meadows	(99 pylon course)
Game 5: Thompson Tourney	(99 pylons and a new course each time you select Game 5)
4. **To begin or start a new game.** Press the SELECT button to position your plane back at the beginning of the course and set your race timer to 0. Then, press the A button or press any direction on the D-Pad to begin a new race.
5. Pressing LEFT on the D-Pad will bank your plane to the left. Press RIGHT, and your plane banks right. Pressing UP or DOWN during a race does not affect movement of the plane. The A button is your plane's throttle. Press it to accelerate. Release it to slow your plane down.
6. **Pylons.** You must fly to the right of the red pylons and to the left of the blue pylons. There is a 3 second penalty each time you fly on the wrong side of a pylon. Your pylon count is shown above the timer on the screen and counts down each time you either successfully pass or crash into a pylon. So, at the end of the race, the count remaining on the screen indicates the number of missed pylons for that race.

SPECIAL FEATURES OF SKY JINKS™ BY ACTIVISION®

Your P41. You'll quickly find that flying your P41 racer is just like real flying.

As you accelerate to full throttle, notice how your racer's altitude increases and your plane's shadow falls back. Using your plane's shadow as a gauge will help you determine your air speed.

Also, notice how your plane banks when turning. And, just like real flying, your P41 accelerates into turns, but it **won't** respond immediately when turning. This delayed reaction gives a more realistic sense of flying.

Obstacles along the course. You'll not only have to properly bank around the pylons to make the best time, but you'll also have to deal with (and dodge) other obstacles as well.

Trees and hot air balloons have been strategically placed along the course to really keep you on your toes and keep you from flying the fastest, most direct path. You'll need to master your racer and be able to make split-second decisions in order to do well in Sky Jinks™.

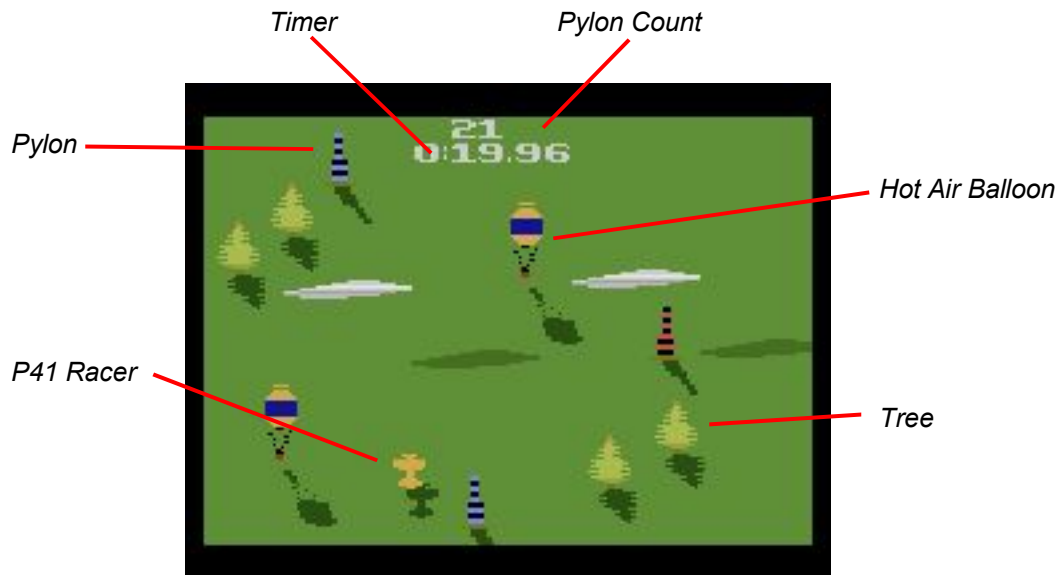

GETTING THE FEEL OF SKY JINKS™ BY ACTIVISION®

In high stakes air racing, you'll need razor-sharp reflexes and a keen sense of anticipation. In order to sharpen your reflexes and really get to "know" your P41 racer, you should take a couple of warm-up runs down the field.

At first, don't even try to fly the pylon course. Just soar at slow speed in a fairly straight path to check out your instruments.

Learn how your plan banks and accelerates. Then, when you're more comfortable with the controls, take a practice run through one of the pylon courses. Learn to anticipate the upcoming pylons and begin turning early, before you reach the pylon marker. At this point, don't even worry about time, there will be plenty of races for time later.

JOIN THE ACTIVISION® "SKY STARS"

If you beat a time of 37.0 seconds on Game 1, without missing any pylons, you can join our Activision® "Sky Stars.". We'll enroll you in this honored club and you will receive our emblem.

HOW TO BECOME A SKY STAR

Tips from Bob Whitehead, designer of Sky Jinks™.

Bob Whitehead is a Senior Designer at Activision. He also designed Boxing, Skiing, Stampede™ and Chopper Command™.

"The key to winning any race is speed. But, in pylon air racing, you'll have to match your speed with flying skills. That means becoming a good judge of distance and how soon or late to begin your turns.

"As your skills really progress, and you become a precision pilot, you should almost be able to fly full throttle through most of a course without slowing down for pylons, trees or balloons. Cut your turns sharply, and try to get as close to the pylons as you can. The path to becoming a "Sky Star" takes lots of patience and plenty of crashes.

"But, remember, even when you do have a mishap and crash into something, quickly accelerate back into the race. You'll be surprised at how good your times can be even after a crash or two.

"And, please stay down from the wild blue yonder long enough to drop me a note. I'd love to hear how your racing career is going. Good luck, good flying and God bless!"



SPACE SHUTTLE – A JOURNEY INTO SPACE™

by Steve Kitchen

1 player

© 1983 Activision Inc.

CONTENTS

FLIGHT PREPARATIONS	188
LAUNCH	190
STABILIZING ORBIT	192
DOCKING	193
DEORBIT BURN	195
REENTRY	197
LANDING	199
ORBITAL MECHANICS	201
ORBITAL MANEUVERING SYSTEM	202
PROBLEMS AND SOLUTIONS	203
EARNING YOUR WINGS	205
FLIGHT NOTES FROM STEVE KITCHEN	206
ACRONYMS	206
STAT MESSAGES	207
GLOSSARY	208

Space Shuttle – A Journey into Space™ is dedicated to the men and women of the National Aeronautic and Space Administration (NASA), without whose kind assistance this game would not have been possible.

IMPORTANT NOTE ABOUT YOUR FLIGHT DECK CONSOLE

Please refer to the official manual of *Activision® Anthology* for Game Boy® Advance to review how to setup and select this game.

You should memorize the following table of game controls. Doing so will help to make the learning curve of this game much easier.

TERMINOLOGY	
GAME SYSTEM	FLIGHT DECK CONSOLE
Power On/Off	Internal Power
L button + DOWN (Color/B&W)	Primary Engines
L button + UP (Left Difficulty)	Backup Engines
L button + RIGHT (Right Difficulty)	Cargo Doors / Landing Gear
L button + UP (Game Select)	Status
SELECT button (Game Reset)	Activate Countdown

IMPORTANT: Since the Primary Engines are fully accessible on your Game Boy® Advance system (by holding the L button and pressing DOWN on the D-Pad), the Left Difficulty Switch (Backup Engines) should NOT be used. Keep Backup Engines offline and **DO NOT TOUCH!**

FLIGHT PREPARATIONS

MISSION PROFILE

It is the 101st Shuttle mission of the Space Transportation System. You are at the helm of the Space Shuttle Discovery. Approximately 210 nautical miles above the Earth is your target: an orbiting satellite with intentionally programmed gyroscope problems.

Your mission is to launch, rendezvous, and dock with the satellite as many times as you can, using the minimum of fuel, then return safely to Earth. A word of caution: Each time you successfully dock, the satellite has been programmed to become even more erratic.

This is a total test of your piloting capabilities. You will be evaluated at the end of your flight.

EQUIPMENT CHECK

Status Switch. Your Flight Indicator. Hold the L button and press UP on the D-Pad to make your Flight Selection (before launch) and to check the following important information: speed, altitude, fuel, MET (Mission Elapsed Time), and stats (see "Stat Messages" for descriptions). Also, hold down L+UP for two seconds during flight to re-start flight.

Primary Engines. Your access switch to all Shuttle engines: Main Engines, Orbital Maneuvering System, and Reaction Control System. Hold the L button and press DOWN on the D-Pad to activate or shut down the engines (**C** setting is ON, **B** setting is OFF).

Backup Engines. Hold the L button and press LEFT on the D-Pad to activate or shut down the Backup Engines (**A** setting is ON, **B** setting is OFF). Since the Primary Engines are fully accessible on your Game Boy® Advance (by holding the L button and pressing DOWN on the D-Pad) you must always keep the Backup Engines in shutdown mode.

Cargo Doors/Landing Gear. A dual function switch used to open and close your Cargo Bay Doors, and to lower or raise your Landing Gear. Hold down the L button and press RIGHT on the D-Pad to toggle this switch (**A** setting is ON, **B** setting is OFF). More on this in later sections.

Hand Controller. The D-Pad is used as a realistic directional hand controller: UP and DOWN move Shuttle forward or back (X axis). LEFT and RIGHT controls your "plane" (left/right) movement (Y axis). With the A button held down, pressing UP or DOWN on the D-Pad moves the shuttle up or down (Z axis). See "Maneuvering in Space" for further explanation. Also, the A button has other uses in launch, orbit, and entry phases as described in those sections.

FLIGHT SELECTION

There are three separate flight modes. Spend time with training flights #1 and #2 before taking on all the challenge of a real, unassisted Shuttle mission (flight #3). Flight mode can only be selected (by holding the L button and pressing UP on the D-Pad) *before* countdown is activated.

Flight #1 – Autosimulator. Flight mode #1 is a combination demonstration flight and autosimulator. The Shuttle flies an abbreviated mission. You do not use any of the console controls. In this flight mode, most aborts (see "Abort indicator") are ignored. Whenever you press any direction on the D-Pad, you take control from that point on. However, you will only need to use your D-Pad to correct your Y axis, and land.

Flight #2 – Simulator. All astronauts spend thousands of hours practicing in ground-based simulators before flying an actual Shuttle mission. In this mode, experience the challenge and demands of a real mission with a couple of important exceptions: You will never use any fuel units, so take your time to complete a mission. Also, your onboard computers will greatly assist you during flight by compensating for less than perfect piloting skills. Most aborts are overridden, but your flight indicator (stat message) will alert you when you've erred.

Flight #3 – STS 101. A full-fledged Shuttle Flight. All aborts are operative and flight conditions are quite realistic. Good luck!

FLIGHT EVALUATION

Abort Indicator. If critical problems occur anytime during a flight, you may receive a "Launch Scrub" or "Mission Abort" signal. If this happens, your flight has ended, and you must check your Status display (by holding the L button and pressing UP on the D-Pad) to find out what went wrong.

Ranking. If you safely land your Shuttle at Edwards Air Force Base, in flight #3, your performance will be computer-evaluated. Your ranking will be determined by the number of successful dockings and the exact number of fuel units you have remaining at the end of your flight:

RANKING	DESCRIPTION	QUALIFICATIONS	
		(Dockings)	(Minimum Fuel units)
Commander	Responsible for overall crew safety and flight execution.	6 or greater	7500
Pilot	Second in command, assists in all flight functions.	4,5	4500
Mission Specialist	Qualified to coordinate mission scientific objectives.	2,3	3500
Payload Specialist	Qualified to operate specific payloads and coordinate Shuttle housekeeping.	1	1

See "Earning your Wings" for important club information.

LAUNCH: DAWN, CAPE CANAVERAL

OBJECTIVE

Launch your Space Shuttle and attain an altitude and orbit as close to the satellite's orbit as possible.

LAUNCH CHECKLIST

Launch Phases. As you fire your enormous main engines and liftoff from the pad, you'll be going through 3 separate phases. The numbers 1,2,3 on your initial computer screen refer to: (1), firing of the SRB's (solid rocket boosters), which really shakes the shuttle, (2), maximum acceleration, and (3), approaching engine shut down. The X indicates MECO (Main Engine Cut-Off).

Thrust. Notice the two, long horizontal bars on the control panel on your screen. "T" stands for thrust, "C" stands for computer. The "C" arrow represents a signal from the onboard computer indicating the proper thrust needed during each phase of liftoff. You control "T" (thrust) using the A button. Always keep both "T" and "C" arrows aligned. Whenever the "T" arrow flashes, you are wasting fuel and should immediately increase or decrease thrust.

Hold Down Bolts. Though your engines are firing, you won't leave the ground until MET +3. The "Hold Down Bolts" will keep your Shuttle on the ground until MET +3 to compensate for the mechanical strain on the Shuttle from firing your engines.

Trajectory/Plane. In addition to regulating thrust, you'll need to also follow the proper trajectory (UP and DOWN on D-Pad), and constantly correct your "plane" (LEFT and RIGHT on D-Pad).

Line Horn. If you stray from the correct launch trajectory, you will waste fuel. To alert you when this is happening, a warning horn will sound. You'll find this feature helpful in avoiding an abort situation.

Separation. A yellow flash at about 65 nautical miles will indicate Solid Rocket Booster separation (SRB SEP). Another flash shortly after MECO (Main Engine Cut-Off) will alert you that the main External Tank has fallen away into the Indian Ocean (ET SEP).

LAUNCH SEQUENCE

1. **Internal Power on.** (Done by default when you boot the game).
2. **Primary and Backup Engines Shutdown:** If necessary, hold the L button and press DOWN on the D-Pad to turn off Primary Engines (**C** setting is ON, **B** setting is OFF). Likewise, hold the L button and press LEFT on the D-Pad to turn off Backup Engines (**A** setting is ON, **B** setting is OFF). (*Reminder: Since your Primary Engines are fully functional, you should never activate the Backup Engines at any time during the mission.*)
3. **Cargo Door closed/Landing Gear up:** Hold the L button and press RIGHT on the D-Pad to make sure that the Cargo Bay doors are closed and the Landing Gear is up (**A** setting is "door closed/gear up", and **B** setting is "door open/gear down").
4. **Activate Countdown:** Press the SELECT button to activate the countdown.
5. **At MET -15 activate Primary Engines:** When the MET (Mission Elapsed Time) reaches -15, hold down the L button and press DOWN on the D-Pad to activate the Primary Engines (**C** setting is ON, **B** setting is OFF).
6. **At MET -4 ignite Engines:** Press the A button to cause engine ignition. Match the "T" arrow with the "C" arrow during launch.
7. **As Shuttle rises, watch both dots on the computer screen:** You must follow the indicated launch trajectory *and* continually correct your "plane" by keeping your Shuttle centered in the small box at right:
 - Press UP on D-Pad to move dot left, DOWN to move dot right.
 - Press LEFT or RIGHT on the D-Pad to correct plane.
8. **At about 205 nautical miles, quickly shutdown engines:** Hold the L button and press DOWN on the D-Pad to shut down the Primary Engines (**C** setting is ON, **B** setting is OFF). The closer you come to the 210 altitude, the closer you'll be to the satellite's orbit.

LAUNCH & ASCENT SUMMARY

Flying the Shuttle into orbit is an extremely challenging task. Following a roller coaster path, you must match your thrust with the computer indicator, stay on the proper trajectory as plotted on the altitude display, and correct your plane as indicated in the small green box. Each area is critical. Incorrect trajectory will cost precious fuel and may abort your mission. A great elevation in the plane setting at MECO will make satellite docking difficult.

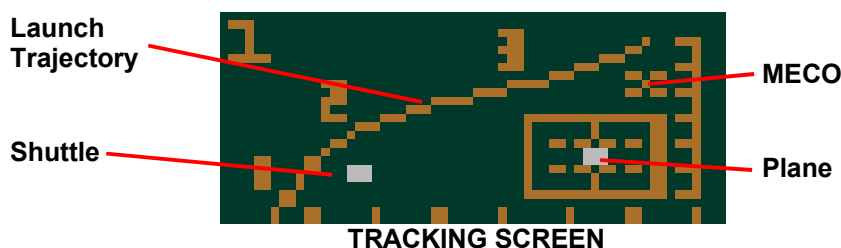

STABILIZING ORBIT

OBJECTIVE

Establish a stable orbit by adjusting Shuttle pitch to enable visual contact, and by opening Cargo Bay Doors for heat release.

STABLE ORBIT CHECKLIST

Nose Down Maneuver. When the Shuttle first achieves orbit, the nose of the craft is pointed up out of the line of sight of the satellite. In order to dock, you must see the satellite. So it's necessary to bring the nose down, which is done by adjusting pitch (the up-down movement of the nose of the Shuttle).

Cargo Bay Doors. One of your first tasks in orbit will be to open the Cargo Bay Doors. This is vital and must be accomplished within first orbit. The radiators that shed excess heat generated by the Shuttle are on the inner surfaces of these doors. If the doors remain closed, heat builds up within the vehicle, and a warning horn will sound. (You then have 30 seconds left to open Cargo Bay Doors.) If the doors aren't quickly opened, the mission will have to be aborted.

SEQUENCE TO STABILIZE ORBIT

1. **Activate Primary Engines.** Hold the L button and press DOWN on the D-Pad to activate the Primary Engines (**C** setting is ON, **B** setting is OFF).
2. **Push Hand Controller forward to set -28 pitch.** Press UP on the D-Pad until your pitch reaches -28.
3. **Shutdown Primary Engines.** Hold the L button and press DOWN on the D-Pad to shut down the Primary Engines again.
4. **Open Cargo Bay Doors.** Hold the L button and press RIGHT on the D-Pad to open the Cargo Bay Doors (**A** setting is "doors open", **B** setting is "doors closed").

STABLE ORBIT SUMMARY

Nose pitch down and Cargo Bay Door events must be performed on the first orbit revolution before any on-orbit operations can be attempted.

DOCKING: 210 NAUTICAL MILES IN SPACE

OBJECTIVE

Properly correct the speed and position (Z, Y, X axes) of your Shuttle to successfully rendezvous with the satellite.

DOCKING CHECKLIST

Maneuvering in Space. There are two separate ways to maneuver your Shuttle in space. For major maneuvers (30 nautical miles or more) the Orbital Maneuvering System (OMS) can be used. This system (explained in a later section) takes a good deal of understanding and experience to use effectively. So, when first starting out, use the Reaction Control System (RCS). These clusters of rocket engines in the Shuttle's nose and tail can move the Shuttle about its three major axes X, Y, Z (called transitional) or about its yaw or pitch (rotational).

Shuttle Speed and Position. Speed is just as important as position. Never allow your speed to drop below mach 17.0, or your altitude to fall below 195 nautical miles, or you'll burn up in the atmosphere! Your X motion to satellite is dependent upon your speed, not the RCS engines. To move toward the satellite, you must increase speed to greater than mach 23.9 (the satellite's speed). When you make your final approach to satellite, keep your speed close to mach 23.9.

Drifting. As you move closer to the satellite, constantly go back and forth to check all axes. Settings continually shift, and the satellite movement is erratic.

"S" Curve. On computer screen #2, the "S" line indicates both the Shuttle's and the satellite's ground track around the Earth. The flashing dot is your Shuttle, the solid dot is the satellite. Notice as you track the satellite, your X axis will suddenly change significantly as the satellite "wraps around" the tracking line. This is because the orbital tracking line wraps around the display as a real orbit would wrap around the Earth.

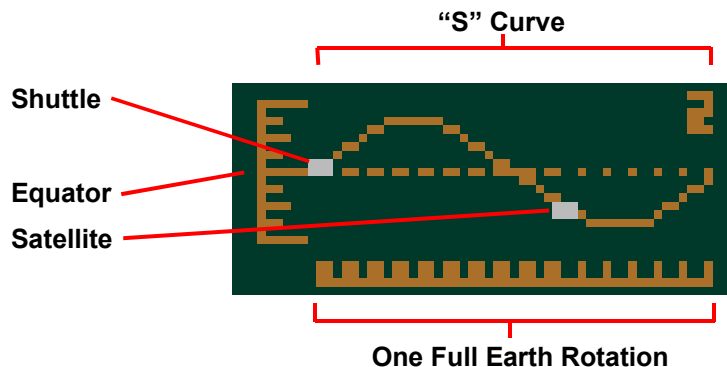

GROUND TRACK SCREEN

Docking Screen. You'll use the "S" curve screen until you get fairly close to the satellite. Then, two smaller radar screens will appear. The left screen shows your Z axis, (up-down), and a wide view of your Y axis, (left-right). The right screen, which you'll use more, shows the X axis (left-right) and micro (close in) Y axis (up-down).

Multiple Dockings. Every time you dock, you receive a "Rendezvous" sign and a certain number of fuel units. However, each docking becomes more and more difficult. So, for each successive docking, you receive more fuel. After each docking, the satellite has been programmed to sail a good distance away from your Shuttle. Wait until it settles ($x = +128$ or -128) before beginning another docking procedure.

DOCKING SEQUENCE

Match the position of your Shuttle with that of the satellite's by correcting your Z, Y and X axes preferably *in that order*.

1. **Correct Z axis to 0:** Hold down the A button and use the D-Pad. A negative number means the satellite is below you, so press UP on the D-Pad to dive. A positive number means the satellite is above you, so press DOWN on D-Pad to climb.
2. **Correct Y axis to 0:** Use the D-Pad. A positive number means the satellite is right of you, so press RIGHT on the D-Pad to line up with it. A negative number means it is left of you. Press LEFT on the D-Pad to line up with satellite.
3. **Correct X axis:** Use the D-Pad. A positive number means the satellite is ahead of you. A negative number means it is behind you. To increase Shuttle speed, press UP on the D-Pad. To decrease speed, press DOWN on the D-Pad. Use the Status switch (hold the L button and press UP on D-Pad) to check Shuttle speed.
4. **Dock:** All axes must be adjusted to 0, and stabilized for 2 seconds, then you will receive a "Rendezvous" signal, indicating you've docked.

DOCKING SUMMARY

You are attempting to dock with a satellite that is travelling at Mach 23.9 and 210 nautical miles above the Earth. You will either need to slow down or speed up to rendezvous (X axis). Also, you will need to be at the same altitude (Z axis), and position (Y axis). All of these maneuvers are interrelated – changing one can affect the others. And, in flight #3, the longer you take to dock, the more fuel you'll use! It is also better to tap the D-Pad than hold it down (saves fuel).

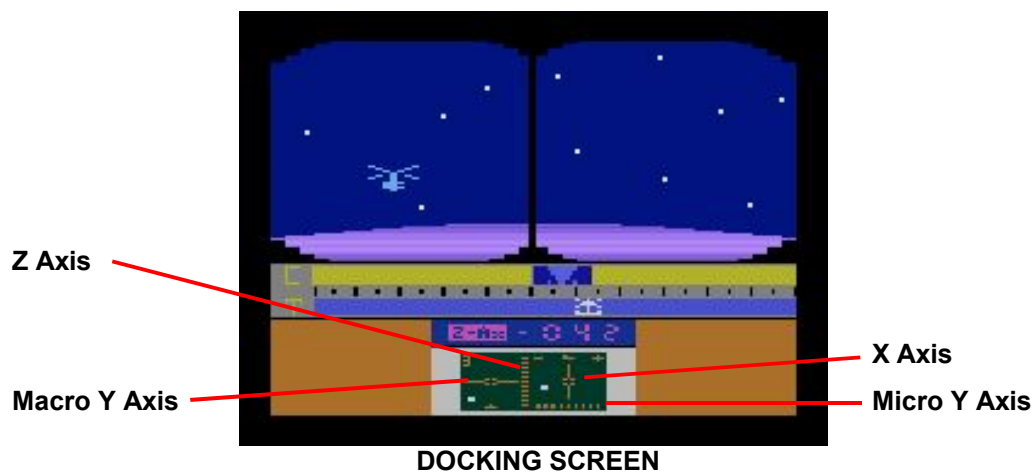

DEORBIT BURN

OBJECTIVE

To turn the Shuttle around, fire the engines, and decelerate to the proper speed.

DEORBIT CHECKLIST

Deorbit Burn Maneuver. You must first turn the Shuttle around so that it is travelling tail-first. Then, in order to maintain the proper altitude, set your Z axis and pitch. Once completed, fire the engines to decelerate. (If the Z axis and pitch are not set properly, firing the engines will make your Shuttle climb or dive). After the deorbit burn, the Shuttle must then be reoriented nose-forward to the proper attitude for reentry. Entering the atmosphere backwards will cause the Shuttle to burn-up.

Yaw. Left–right rotation of the nose of the craft.

Satellite Interference. Before attempting a deorbit burn, you must allow the satellite to pull a safe 128 nautical miles away from the shuttle. If you don't, your deorbit burn will be unsuccessful, and you'll never leave orbit!

SEQUENCE FOR DEORBIT BURN

1. **Check X axis by tapping DOWN on D-Pad.** Wait until $x = 128$ miles *before* proceeding ($x = +128$ or -128).
2. **Check your speed.** Hold the L button and press UP on D-Pad to access the Status screen, which displays the Shuttle's speed. Press DOWN or UP on the D-Pad to set speed at Mach 23.9.
3. **Correct Z axis to 0.** Press the A button and press UP or DOWN on the D-Pad to correct your Z axis.
4. **Activate Primary Engines.** Hold the L button and press DOWN on the D-Pad to activate the Primary Engines (**C** setting is ON, **B** setting is OFF).
5. **Turn the Shuttle around.** Press LEFT on the D-Pad to set yaw at -128 .
6. **Set pitch at -004.** Press UP or DOWN on the D-Pad to set the pitch at -004 .
7. **Display speed (SP/m), speed in Mach.** Bring up the Status screen by holding the L button and pressing UP on the D-Pad, in order to monitor your speed.
8. **Ignite engines.** Press the A button to ignite, and then hold down the A button until speed = 19.0.
9. **Reset yaw to exactly 0.** Press LEFT or RIGHT on the D-Pad to set the yaw properly.

DEORBIT SUMMARY

Deorbit is one of the most critical phases of your flight.

Following completion of orbital operations, the Shuttle is oriented to a tail-first attitude, then decelerated to a necessary speed for reentry.

The orientation of the Shuttle is established by the RCS engines, and deceleration is provided by the larger OMS engines.

You begin to lose altitude once you've slowed the Shuttle down below the actual velocity needed to sustain your 210 mile orbit.

REENTRY

OBJECTIVE

To establish and maintain the correct pitch, yaw and speed; follow the correct trajectory; and properly manage heat build-up during reentry.

REENTRY CHECKLIST

Entry Interface. This is the point in your flight where atmospheric entry officially begins. As the Shuttle descends, atmospheric drag dissipates tremendous energy, generating a great deal of heat. This heat quickly builds up (portions of the vehicle's exterior reach 1540°C). Pitch and speed must be correct to properly utilize the Shuttle's Thermal Protection System.

Terminal Area Energy Management. After entry interface, you must closely follow the proper descent trajectory in order to maintain enough altitude and speed to reach the final touchdown point. This process of conserving your energy by maintaining the correct position, altitude, velocity and heading is called Terminal Area Energy Management (TAEM).

Loss of Signal. During reentry, the Shuttle superheats the gas of the upper atmosphere, creating flashes of color outside your window. Heat strips electrons from the air around the Shuttle, enveloping it in a sheath of ionized air that blocks all communication with the ground. So, at 160 miles, you will experience a temporary partial loss of signal (LOS). Keep a close eye on your radar at this point. You will receive intermittent signals which you need to use to correct your course and plane.

Descent Screens. On your reentry screen, "X" indicates cut-off of your OMS engines (deorbit burn). "T" indicates the Terminal Area Energy Management Phase. "L" indicates your transition to final landing approach. The small box at left is your plane indicator.

REENTRY SEQUENCE

1. **Press DOWN on the D-Pad to set +24 pitch.** This is necessary for having proper reentry attitude.
2. **Close Cargo Bay Doors.** Hold the L button and press RIGHT on the D-Pad (**A** setting is "doors open", **B** setting is "doors closed").
3. **Follow reentry course on computer screen.** Press DOWN on the D-Pad to move right on the computer screen; press UP to move left. LEFT and RIGHT on the D-Pad are used to center the plane.

REENTRY SUMMARY

There are three important stages to Reentry: Entry Interface, TAEM, and LOS. Position, altitude, velocity and heading must all be exact to both properly manage the tremendous heat buildup and correctly position your shuttle for the Final Approach.

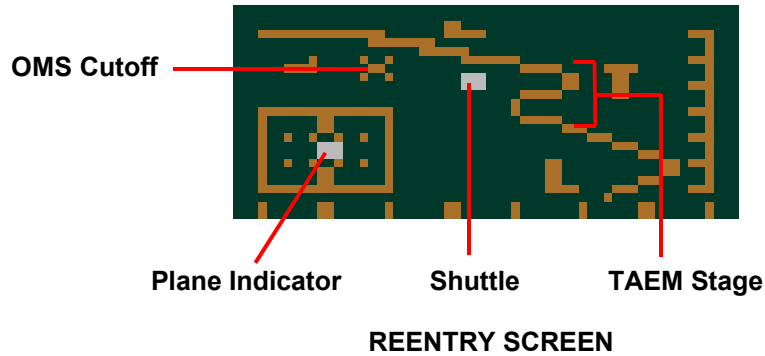

RETURNING TO EARTH

- DEORBIT BURN TO SLOW SPEED
- BEGIN DESCENT
 - MAXIMUM HEATING
 - FOLLOW GLIDEPATH
 - TERMINAL AREA ENERGY MANAGEMENT
 - TURN TO BEGIN FINAL APPROACH
 - BEGIN TO PULL NOSE UP
- PREPARE TO DROP GEAR
- WHEELS DOWN
- TOUCH DOWN

LANDING: EDWARDS AIR FORCE BASE, CALIFORNIA

OBJECTIVE

Properly following the final approach course, maintain the correct pitch and descent rate to safely land.

LANDING CHECKLIST

Final Approach. As you leave the reentry phase and enter your final approach, the first thing you'll see are the mountains around Edwards Air Force Base. You'll hear two sonic booms caused by your craft and the chase planes. At this point, your Shuttle is a glider.

In order to maintain enough altitude and speed to reach the touchdown point, you'll need to make an extreme right turn which will leave you lined up with the runway entry point.

Landing Screens. Now, closely watch all your flight instruments on the front control panel. At this point events happen quickly. You will need to keep your nose pulled down to slow descent while constantly watching altitude and range. Lines on the left screen box, (Altitude Direction Indicator) indicate the ideal trajectory or path and your upper and lower safe limits. The right box is your Horizontal Situation Indicator. It shows your position relative to the runway.

Range. Range is the distance from the edge of the runway to your shuttle. So, when range is negative you're above the runway.

Surface Conditions. Since you're in the desert, crosswinds can become a real problem. Compensate by constantly pressing UP, DOWN, LEFT or RIGHT on the D-Pad to maintain the proper trajectory and descent rate until touchdown. Just because you're close to home – don't let up on your concentration.

LANDING SEQUENCE

1. **As soon as you see the mountains, make a right turn.** Line up Shuttle on runway using radar screen.
2. **Follow final approach course on both computer screens.** Left screen: Keep dot centered between the two arched lines. Right screen: Keep dot centered on straight runway approach line. Press UP on the D-Pad lower nose (quicken descent). Press DOWN on D-Pad to raise nose (slow descent). Press LEFT or RIGHT to keep dot centered.
3. **Press the A button to display altitude.** Release the button to display range.
4. **When range goes negative, you're over the runway,** just seconds from touchdown, so drop landing gear NOW, by holding the L button and pressing RIGHT on the D-Pad (**A** setting is "gear up", **B** setting is "gear down").
5. **Press UP on the D-Pad to lower nose.**
6. **When Shuttle hits runway, your nose will pop up,** so keep pressing UP on the D-Pad to keep nose down until you hear the thud of the front landing gear.

LANDING SUMMARY

During the final approach, descent speed is critical. You will be conducting a series of "flares" (nose-up maneuvers) that reduce speed which is necessary for landing. So, not only will you need to center the Shuttle on the runway, but also you must maintain the proper pitch at the same time. Sounds are important during this phase. Use them to monitor your progress. In addition to the sonic boom as you break through the atmosphere, you'll hear a constant beeping effect which will increase in speed the closer you get to the runway, a high-pitched warning horn after you've passed over the runway (a signal to put your landing gear down), landing gear lowered, and (main gear) tires screech when you've touched down.

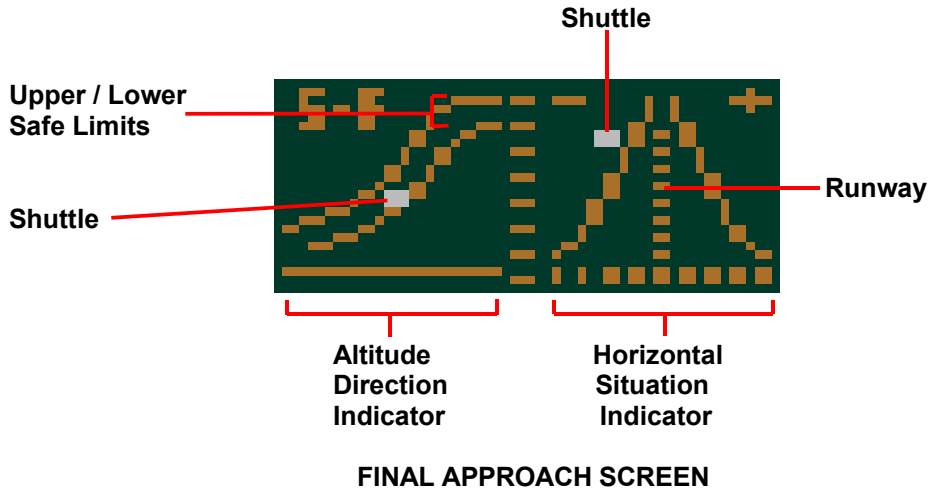

ORBITAL MECHANICS

You've successfully launched your Shuttle into orbit. Now it's time to dock with the satellite. Whether you're making position corrections using the OMS or RCS engines, remember that every action you take may affect your axis (X, Y, Z) or altitude. For example, if your pitch is -028 (nose-down) and you perform an OMS burn to correct your X axis, your altitude will drop because you're actually pointed towards the Earth.

Try and picture the position of the shuttle in your mind as you're orbiting. Use the diagram below to help you visualize Shuttle positioning. And remember: minimum speed is Mach 17.0 and minimum altitude is 195 nautical miles, or your orbit will destabilize and the vehicle will burn up in the the atmosphere.

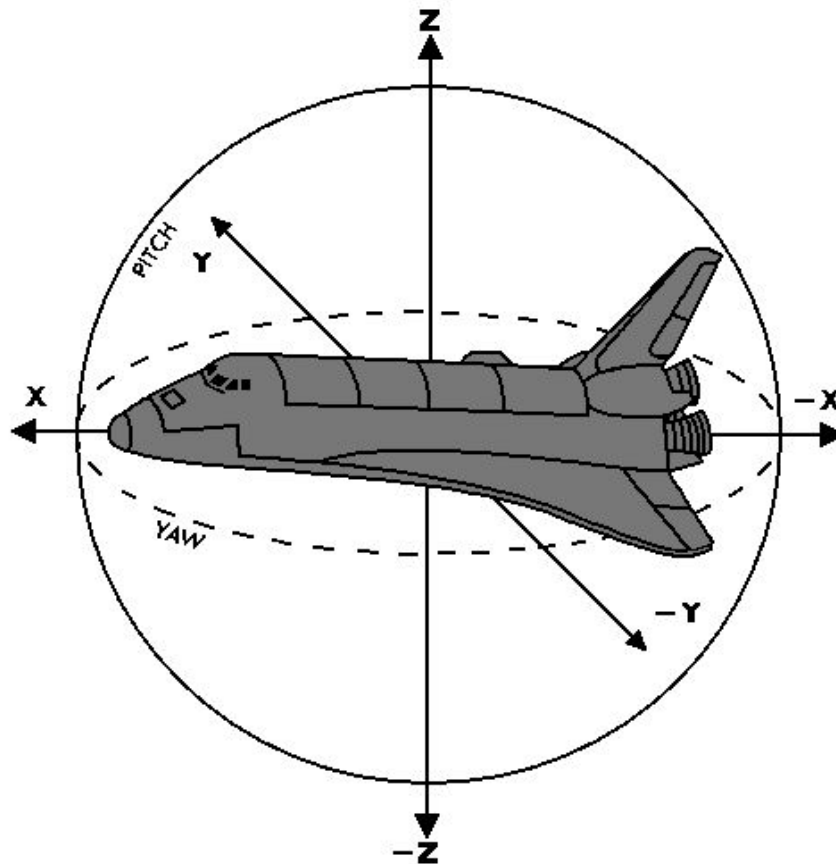

AXIS
Z = Vertical distance to earth
Y = Left and right distance to satellite
X = Forward and back distance to satellite
PITCH = Up-Down of the nose of the craft
YAW = Left-right rotation of the nose of the craft

ORBITAL MANEUVERING SYSTEM

For smaller, precise adjustments, you'll want to achieve orbital maneuvers with your Reaction Control System (RCS) engines. They're easier to use. However, time means fuel. Housekeeping fuel – used to keep the various electrical equipment and life support systems of the Shuttle operating – is constantly being expended. So, it's imperative you make your orbital corrections as efficiently and quickly as possible. This is where your OMS engines can be a great aid. When making maneuvers (30 nautical miles or more) use your 12,000-pound-thrust OMS engines. However, since using the powerful OMS engines can dramatically affect altitude, READ THE FOLLOWING INSTRUCTIONS CAREFULLY.

X AXIS CORRECTIONS USING OMS ENGINES

When flying forward on X (0 Yaw) using your OMS engines, your altitude will drop faster if your pitch is zero or negative. When flying backwards on X (-128 Yaw) using your OMS engines, your altitude will rise if your pitch is positive or zero, and your altitude will not be affected by the OMS burn if your pitch is negative.

SEQUENCE

- Set pitch to correct value.
- Set display to "X" axis, speed or altitude.
- Set yaw to - or +128.
- Press the A button to fire engines.
- Restore yaw and pitch to correct values.

Y AXIS CORRECTIONS USING OMS ENGINES

As you perform a Y OMS burn, you'll see your Y indicator change. If you forgot to change your pitch to 0, your altitude will change. A positive pitch will make you fall. A negative pitch will force you to rise. A non-zero pitch also burns extra fuel.

SEQUENCE

- Set pitch to correct value.
- Set yaw to - or +64.
- Press the A button to fire engines.
- Restore yaw and pitch to correct value.

OMS Summary. In other words, when correcting either X or Y axis using your OMS engines, *altitude may be affected*. Taking this into account, it is possible to make both Z (vertical) *and* X or Y corrections, all in the same maneuver – if very skillfully done.

PROBLEMS & SOLUTIONS

LAUNCH: PROBLEMS

PROBLEM: MET-15 does not appear. Screen only comes up STAT.

SOLUTION: Check switches. Primary and Backup Engines must be shut down. Cargo Doors must be closed. Try again.

PROBLEM: "Launch Scrub".

SOLUTION: You're igniting your engines prior to or too long after MET-004. Wait for launch system to recycle and concentrate on firing as close to (but not before) MET-004 as possible.

PROBLEM: Line horn continually sounds during launch.

SOLUTION: Keep dot (your Shuttle) slightly on the low side of the trajectory line to maintain proper course.

STABILIZING ORBIT: PROBLEMS

PROBLEM: Initial orbit position too low, or speed too slow.

SOLUTION: You're shutting off your engines before proper altitude is achieved. Cut-off your main engines as close to 205 miles as possible.

PROBLEM: "Mission Abort" signal as soon as you shut down engines.

SOLUTION: Dependent upon your Abort number, either: speed/altitude were too low to sustain orbit; you were far off the trajectory line at MECO; you shut down your engines too early, or your orbit insertion angle was incorrect. Either you were very far off the trajectory line or your plane (right-left position) was incorrect.

PROBLEM: Once in orbit, Y axis is off badly.

SOLUTION: Plane (right-left) was not centered at MECO.

PROBLEM: Once in orbit, Z is off badly.

SOLUTION: You shut down your engines too early. Remember, your Z axis is directly related to your altitude. The lower your altitude, the more negative your Z axis. A Z-15 axis equals an altitude of 196.0 miles. When Z axis equals 0, altitude is 210 nautical miles, the altitude of the orbiting satellite.

PROBLEM: Once in orbit, X is off badly.

SOLUTION: Cargo Bay Doors were closed too long and Shuttle overheated. You have approximately 30 seconds to open Doors after you achieved orbit.

DOCKING: PROBLEMS

PROBLEM: Although axes are adjusted, satellite is never sighted and docking screens never appear.

SOLUTION: Check your pitch and Yaw. If pitch is not -28 (Shuttle nose-down), you'll never be in line of sight of satellite. If Yaw is + or -17 or greater, you'll also be out of line of sight (Shuttle line of sight will be too far left or right). With the Z and Y axes adjusted to 0, docking screens should appear when the satellite is a X + or -16, assuming pitch is -28 and yaw = 0.

PROBLEM: Conducting OMS burn sends Shuttle into dramatically high or low altitudes.

SOLUTION: Check your pitch. *Always* make sure your pitch is 0 before conducting an OMS burn unless you intentionally wish to adjust altitude during burn.

PROBLEM: Axes all adjusted. Satellite spotted. But, you can't dock.

SOLUTION: Check your speed. The satellite always travels at Mach 23.9. So, if you're having trouble docking, adjust Shuttle speed + or -1 Mach.

REENTRY: PROBLEMS

PROBLEM: After conduction a successful Deorbit Burn, you still aren't losing altitude for reentry.

SOLUTION: The satellite may be interfering. Wait until it is at least 128 miles (X axis) away before conducting a deorbit burn. Also, make sure your altitude is 210 (Z axis 0) and speed is Mach 23.9 before attempting burn.

PROBLEM: Burn up during reentry.

SOLUTION: If your pitch is greater than +24, your Shuttle cannot be protected by its special insulation. If pitch is less than +24, you'll skip into space. If yaw does not equal 0, you'll spin out. And if your Cargo Bay Doors are left open, your shuttle will also burn up.

LANDING: PROBLEMS

PROBLEM: Mission Abort as soon as you break through the cloud covering.

SOLUTION: You cannot be off course (Klaxon horn is on) during the last few seconds of your reentry (screen). This will place you in the wrong position for Final Approach – altitude and speed will be adversely affected! So, stay right on course at the end of reentry – don't let up.

PROBLEM: You crash into the desert floor.

SOLUTION: This is probably a result of improper use of your Altitude Direction Indicator (ADI). The ADI is your left computer screen during landing. It tracks your altitude and descent. Always keep the Shuttle above the lower of its two lines.

Pressing UP or DOWN on the D-Pad helps to do this by raising or lowering the nose of the Shuttle (quickers or slows descent).

Importantly, as soon as you drop landing gear (by holding the L button and pressing RIGHT on the D-Pad), drag will cause the nose to flare up. So, when landing gear is dropped, hold UP on the D-Pad to bring and keep nose down.

EARNING YOUR WINGS

Pilots are a skilled and hearty breed indeed. If you're able to successfully dock your Shuttle five times and land with at least 4,500 units of fuel, you're worthy of Pilot status and an official Pilot patch.

If, after hours of hard training, study and preparation, you make that sixth and final satellite docking with at least 7,500 fuel units in your tanks, you'll be one of the few, the proud, the elite – Space Shuttle Commanders! Anyone achieving this magnificent ranking will be rewarded with a distinguished on-screen display! You will also receive the appropriate patch for your efforts.



LANDING SCREEN EVALUATION

FLIGHT NOTES FROM DESIGNER, STEVE KITCHEN

"Ever since I can remember, the Space Program has meant something very special to me. Every time a mission took off, so did my imagination.

"That's why designing a home video version patterned after the real Space Shuttle seemed so appealing – yet challenging. It was quite a task to achieve maximum accuracy in my work.

"In the photo on this page, I'm sitting in an actual NASA Space Shuttle simulator. It gave me a firsthand look at what our astronauts really go through. And I can assure you the Space Shuttle cartridge you now have is quite true to real life.

"So, don't be discouraged if you don't achieve Commander on your first flight. There are plenty of skills and a whole lot of knowledge you need to master first. I strongly suggest you fly Space Shuttle with a friend as co-pilot – functioning as navigator and assistant.

"Learn and understand this manual. The knowledge you gain will not only help with my program but, who knows, may get you a seat on the next real trip into orbit."

Steve Kitchen is a master software designer, engineer and inventor. He was involved in the development of digital watches, the first handheld electronic games and electronic calculators. Steve welcomes and encourages your letters, comments and questions regarding his first work for Activision.

ACRONYMS

AX:	Axis
ALT:	Altitude
FLT:	Flight
MET:	Mission-Elapsed Time
MECO:	Main Engine Cut-Off
OMS:	Orbital Maneuvering Systems
RCS:	Reaction Control System
RNG:	Range
SRB:	Solid Rocket Booster
SP/M:	Speed in Mach
SSME:	Space Shuttle Main Engine
STS:	Space Transportation System
TAEM:	Terminal Area Energy Management
DAP:	Digital Auto Pilot

STAT MESSAGES

If you're encountering a problem, or just want to check your status, hold the L button and hold UP on the D-Pad until "STAT" appears. Then, use the following guide. Operational messages are prelaunch alerts. However, Mission Abort messages mean you've made a catastrophic mistake (Flights #2, #3 only) and must relaunch. For further explanations for some of these messages, see "Problems & Solutions."

MESSAGE NUMBER	MESSAGE OR ACTION NEEDED <i>(Prelaunch – Non Abort)</i>
0	All clear
4	Shutdown Primary Engines
24	Shutdown Primary and Backup Engines
44	Shutdown Primary Engines and close Cargo Bay Doors
64	Shutdown all Engines and close Cargo Bay Doors
20	Shutdown Backup Engines
40	Close Cargo Bay Doors
60	Shutdown Backup Engines and close Cargo Bay Doors

MESSAGE NUMBER	MESSAGE OR ACTION NEEDED <i>(Inflight – Mission Abort)</i>
0	All clear
1000	Not lined up with runway on touchdown
7000	Altitude too low to sustain orbit (below 195)
7500	Altitude too high (255 miles maximum)
9500	Speed/altitude too low to attain orbit at MECO
1500	Touchdown too early (hit desert)
2000	Touchdown too late (run off runway)
3000	Nose gear not down at end of runway
3500	Not on course at beginning of banking turn (Klaxon horn is on)
4000	Landing gear not down at touchdown
8500	Cargo bay doors not open during orbit (overheat)
5000	Cargo bay doors not closed at ascent or entry interface
8000	Speed too low to sustain orbit (below Mach 17)
5500	Pitch greater than 24 on reentry into atmosphere (skip into space)
6000	Pitch greater than 24 on entry interface (burn up)
6500	Yaw not 0 on entry interface
9000	Orbit insertion angle incorrect at MECO
9900	Out of fuel

MESSAGE NUMBER	MESSAGE OR ACTION NEEDED <i>(After safely landing)</i>
1–99	Number of dockings. Also may appear as the last digit of a Mission Abort stat.

GLOSSARY

APOGEE: The highest point of an earth ORBIT.

ALTITUDE: Vertical height from Earth's mean surface (sea level).

ATTITUDE: The position of the vehicle; for example, flying tail-first with cargo bay toward the earth.

AXIS: A line through a body about which it rotates.

CONFIGURE: To set equipment to certain specifications.

DEORBIT BURN: The firing of a RETRO-ROCKET to slow the spacecraft to a speed lower than that required to maintain ORBIT. On the Orbiter, this is accomplished with the orbiter maneuvering system (OMS) engines.

GLIDESCOPE: The angle at which you descend in the Orbiter or other glider with respect to the ground.

KILOMETER: 1000 meters, or 0.621 of a mile.

MACH: The term used to describe the speed of objects relative to the speed of sound (about 690 mph). For example, Mach 2 is twice the speed of sound. The shuttle travels through space (in orbit) at approximately 22 mach or 17,000 mph.

ORBIT: A balance between a body's inertia, or tendency to fly off into space, and the gravitational attraction of a central object.

PITCH: Up-Down rotation of the nose of the craft (see Roll and Yaw).

RANGE: Distance to edge of runway.

RETRO-FIRE: To fire engines in the direction of motion in order to reduce forward velocity. In orbit, this permits gravity to pull you downward.

ROLL: To rotate about an axis from front to back (nose to tail) of the Orbiter. To the pilot, a roll is like a cartwheel (see Pitch and Yaw).

RENDEZVOUS: To meet in space and orbit together.

ROTATION: Movement of the Orbiter around its three principal axes producing Pitch, Yaw, or Roll.

TRAJECTORY: Flight Path.

YAW: Left-Right rotation of the nose of the craft (see Pitch and Roll).



ATARI 2600

SPACE TREAT DELUXE



Use with Joystick Controller
© 2003 FABRIZIO ZAVAGLI
CARTRIDGE MADE BY ATARIAGE

SPACE TREAT DELUXE

Homebrew game by Fabrizio Zavagli

1 player

© 2003 Fabrizio Zavagli

INTRODUCTION

Your planet, a peaceful Class M world, has always been living in harmony and this allowed its people to quickly evolve into the space era. Anyway, as you might have guessed, no good is going to last. There came a time where the forces of evil, namely your neighbor planet, started to strike against you. The evil planet's inhabitants are quite different. They don't care about nature and peace. They are greedy, and only think about consuming the planet's sources to gain more and more riches. This quickly led to a total draining of anything their planet had to offer, making them more and more envious of your prospering world. Unable to obtain any more of their environment, the evil planet sent its combat drones to attack your world, aiming at stealing your food resources. Unfortunately, they're succeeding in getting their tentacles on your valuable goods, trapping them in a space cage above your planet...

OBJECT OF THE GAME

Your mission is to bring back as much food as possible before the drones take it away with them.

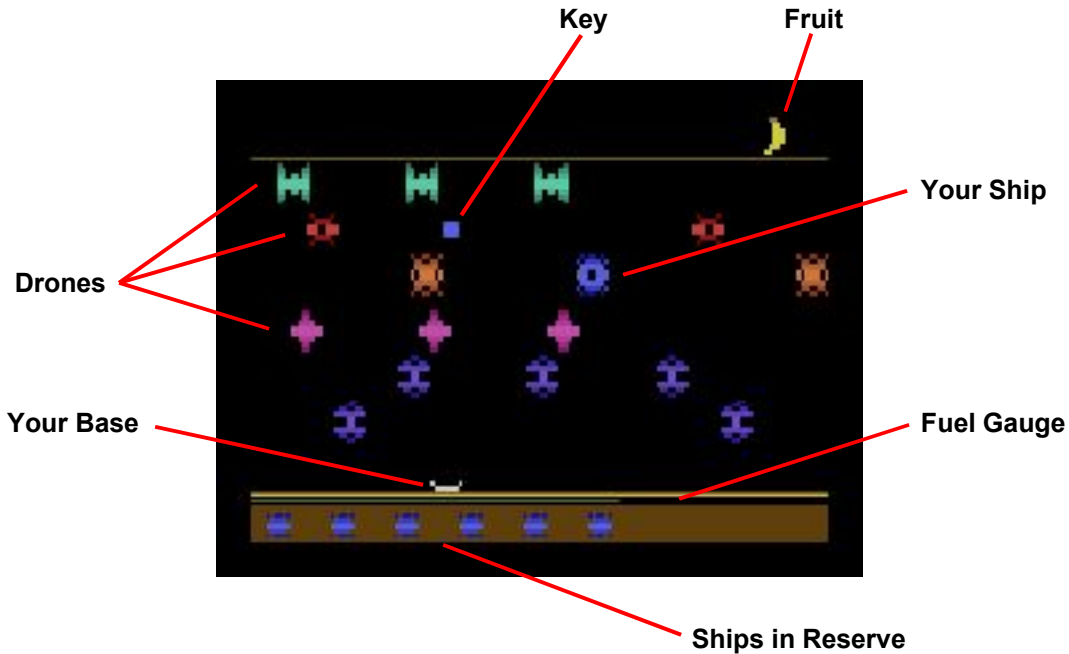

HOW TO PLAY

Please refer to the official manual of *Activision® Anthology* for Game Boy® Advance to review how to setup and select this game.

The controls of Space Treat Deluxe are as follows:

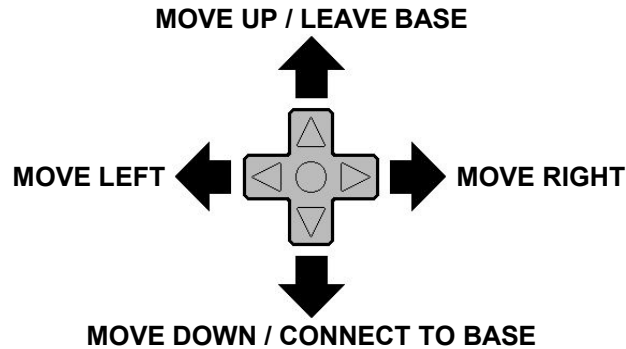

- Both the A button and SELECT button start the game. Also use the SELECT button to get back to the title screen.
- The difficulty and game select switches are not used in this game. In other words, holding the L button and pressing LEFT, RIGHT, UP or DOWN on the D-Pad produces no effect.

In order to complete your mission, you will have to guide your ship to the upper level of the screen, where the cage (represented as a horizontal line) is located, while avoiding the mortal contact with the enemy drones. Position the ship under the opening (door) in the cage and press UP to collect the food. At this point, the enemy will detect you and send a new drone, so quickly get back to the base in order to move on to the next level. After the first few stages, the door in the cage will become locked. You will be forced to collect a Passkey, graphically represented as a square, to unlock the cage.

During your trips, you will have to keep an eye on the fuel level that constantly decreases once you leave the ground. When it's low, it will become yellow. Should it turn red, your ship will move slower and if it runs out, you'd better prepare the next ship! But be careful, because you have a limited supply of 6 ships. You will also lose one when crashing against drones. Getting your ship destroyed will also result in losing the food you're carrying. Maneuver carefully!

LEVELS

Space Treat Deluxe contains 99 levels of increasing difficulty.

The first 2 levels are the easiest ones, useful for basic control practice. Starting from level 3, the cage containing food will be locked and you will have to collect a Passkey in order to open it.

Level 7 and above are the most difficult ones, with speeding drones adopting advanced movement patterns.

Level structures change each time you play.

Every new game is a different challenge!

SCORING

100 points for each remaining ship at the end of level.

10 points for each fuel unit saved at the end of level.

1000 points for clearing level without losing a life.

Additional bonus ranging from 10 to 1000 for each stage cleared (bonus amount depends on your current level).

PLAYING TIPS

- Always carefully choose the location where you will leave your base, as the fuel will not decrease while you're connected to it, but you won't be able to get back to the base until you collect the food.
- Take some time to examine the movement patterns of the drones to find the best place and time to start your trip, both upward and downward.
- You can take a break between levels, since the game will wait for you to push the A button before starting a new screen.

ABOUT THE GAME

Space Treat was started in May 2002 as my first homebrew. The idea has evolved a lot during the creation process, with many features being included or scrapped. A lot of suggestions came from the people on the Stella List, and great support from the AtariAge forums and other individuals.

ABOUT THE AUTHOR

I started my programming experience as a kid, once I understood that creating games could have been at least as much fun as playing them. Being quite too young to fully understand 6502 assembler on my Commodore 64, my early years passed by with mostly basic programming. But the call for speed was strong, and I often tried my hand at 8-bits assembler. By the end of the '64 era, I'd managed to grasp the basics of machine language. After the C64 came the Amiga, along with the powerful and readable 68000 assembler. That's where I've had most of my assembler activity, coding demos that were released in the, at the time, intense demo group scene. Long hours spent on assembler can really open your mind to the inner workings of hardware and software, something that's being lost as more and more generations of programming languages surface. Nowadays, even if my daily job is not related to games or low-level programming, I keep doing asm coding for fun, both because I love Atari and since it's a great exercise.

ACKNOWLEDGEMENTS

Without the help and support from the following people, this game would have never been started and much less finished:

- Cristina
- AtariAge (Albert Yarusso and Alex Bilstein)
- Randy Carihfield
- Thomas Jentzsch, Manuel Polik, Dennis Debro, Eckhard Stolberg, Andrew Davie, Paul Slocum and all the people on the Stella List (sorry all others I've forgotten!)
- All the great guys from the AtariAge forums
- Daryl Litts
- Davide Pasca (Kazzuya)
- Fabrizio Farenga
- Fabio Pacifici (Jag)
- Lorenzo Lapi
- Antonio Daniele
- Christian Padovano
- Sergio Paolantonio (Raoul)

... and everyone else who took the time to write in to support the creation of Space Treat!

HISTORY NOTES ON SPACE TREAT

- Space Treat first Solid State release: CGE2k2 (Aug. 10–11 2002) as a Special Edition
- Space Treat .BIN release: August 12, 2002
- Space Treat Deluxe release: PhillyClassic 4 (March 28–30, 2003)
- Developed with z26 and CyberStella emulators and a CuttleCart.



SPIDER FIGHTER™ BASICS

The object of the game is to protect your fruit orchard from insect fruit thieves, scoring points by exterminating the attackers.

1. Please refer to the official manual of *Activision® Anthology* for Game Boy® Advance to review how to setup and select this game.
2. Hold the L button and press LEFT on the D-Pad to choose between the regular game (**A** setting) and expert game (**B** setting). This affects the speed, fire-power and point values of insects.
3. Hold the L button and press RIGHT on the D-Pad to select the way pellets are guided: In the **A** setting, pellets move upward in a straight line, and in the **B** setting, pellets can be guided with the D-Pad.
4. Holding the L button and pressing UP on the D-Pad has no effect in this game.
5. **To begin or start a new game.** Press the SELECT button. Action begins when the first Master Nest descends.
6. **How to play.** Fire poison pellet volleys by repeatedly pressing the A button. Press LEFT or RIGHT on the D-Pad to move mobile blaster left or right across the screen.
7. **Fruit Orchard.** Your fruit orchard is growing oranges, grapes, strawberries and bananas. You must protect each variety of fruit from waves of insects. Four waves attack oranges, grapes and strawberries. Then, unlimited waves of insects attack your bananas. Each wave starts out with three fruit and four Master Nests.



Strawberry

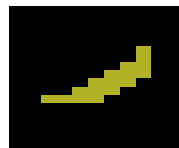

Banana

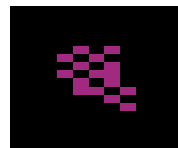

Grapes

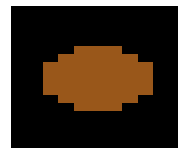

Orange

8. **Reinforcements.** You begin each game with four bug blasters in reserve. If you manage to save all three fruit from an insect wave, you're awarded an additional blaster. You can only have up to four reserve blasters on the screen at one time.

9. **Scoring.** Each time you exterminate an attacking insect, you score points. The point values for each insect are listed below:

SPIDER FIGHTER™ POINT SYSTEM

Insect	Point Values (Regular game only)
Master Nest	100
Stinger	50
Spy Pod	50
Green Widow	30

In the expert game, point values for insects are multiplied when you are protecting certain fruit: insects are worth twice as much when protecting grapes, four times as much for strawberries, and eight times as the regular game point values when bananas are present.

Bonus points: If you manage to save all three fruit in a wave, and you also have four bug blasters in reserve, then you will receive 500 bonus points.

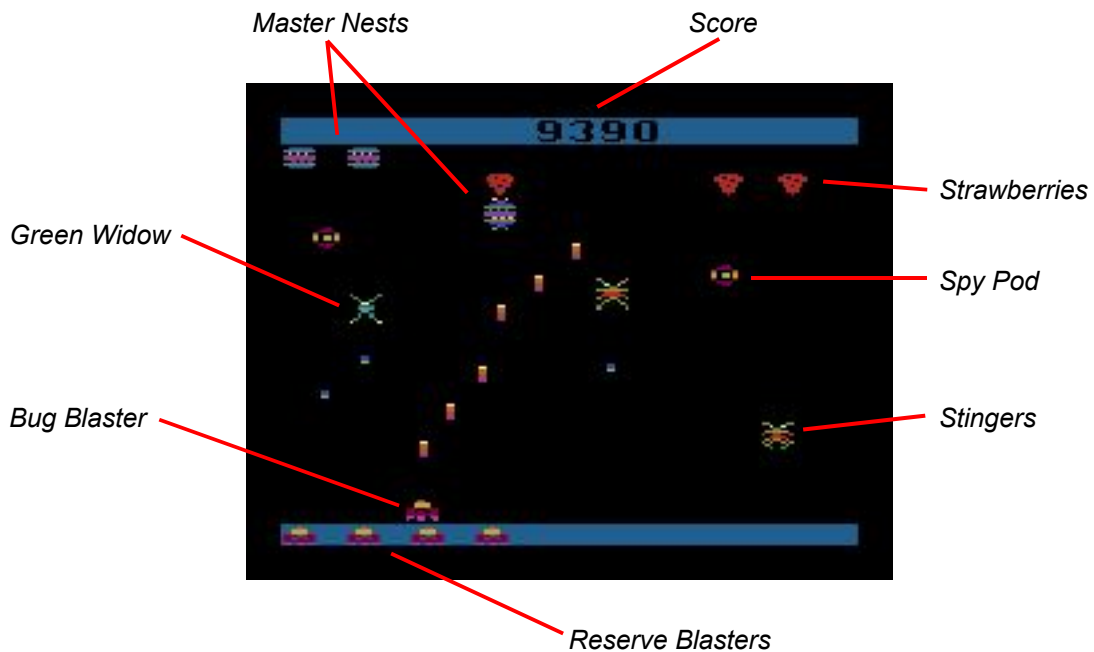

BUG GLOSSARY

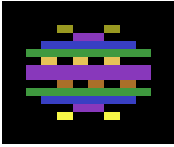

The Master Nest. This is the ringleader and major fruit thief. It is protected from poison by a white band, until it releases a Spy Pod. Its sole aim is to keep you busy with bugs, so that it can slip away with your fruit.



Spy Pods. These sneaky critters scout around and instruct the Master Nest to release more insects. As long as any Spy Pods remain on the screen, the Master Nest continues to release its creepy offspring. Destroy the Spy Pods and you slow the infestation!

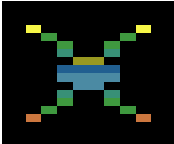

Green Widows. Green Widows fly interference, protecting the Master Nest with cover-fire. They also act as living shields, sacrificing themselves by intercepting your poison pellets. Even though Green Widows are slower and dumber, by careful! They still deal a deadly bite.



Stingers. The most dangerous and aggressive of the pack. Stingers track your blaster with the single-minded goal of destroying you. Warning! When you kill the Master Nest, Pods and Widows instantly transform into Stingers! Then, the mortality rate is very high.

HOW TO JOIN THE ACTIVISION® “SPIDER FIGHTERS”

If you score 40,000 points or more on the regular game level, you qualify for Activision's elite corp of Spider Fighters. We'll give you an official Spider Fighters emblem.

BECOMING A MASTER BUG BLASTER

Tips from Larry Miller, designer of Spider Fighter™.

Larry is the newest addition to the Activision design team. He's an experienced designer, having completed a number of games for home computers.

"As you can see, keeping a fruit orchard isn't exactly easy. Those bugs can really become a nuisance. You can never get rid of them entirely, but you can control them.

"There are various strategies you can experiment with, but one of the most effective that I have found is to first gun down the lone Spy Pod. If you can exterminate that Pod, you halt the flow of reinforcements. Afterwards, you can pick off the rest of the attackers, leaving the Master Nest for last.

"Occasionally, the Master Nest will release a continuous stream of Spy Pods, and each one you hit seems to be replaced. If this happens, you must immediately destroy the Master Nest and take your chances against a squadron full of angry Stingers. Normally, though, it is best to destroy the slower Spy Pods and Green Widows that hover near the bottom of the screen before killing the Master Nest. A low-flying Stinger is your worst enemy.

"So maintain a stiff upper lip, and send me a line in between Spider Fights. I'd sure like to know how this year's fruit harvest will fare."

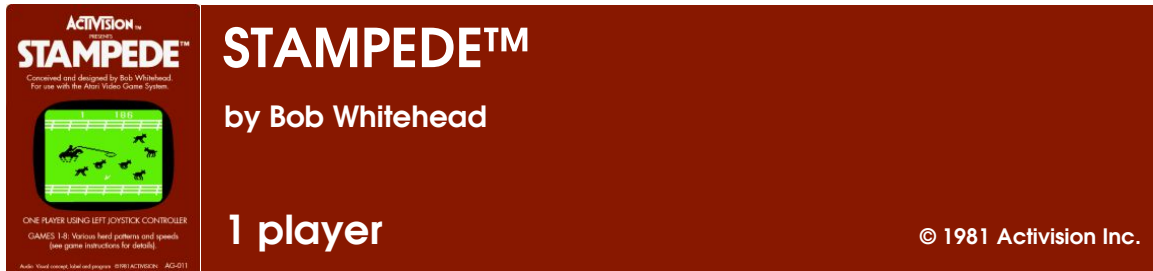

So you want to be a cowboy? Well, greenhorn, it can be tricky. So, before ya start to lasso them dogies, you'd best learn the ropes. That's why you should read these instructions first. Real careful-like. Then saddle-up... and head'em out!

STAMPEDE™ BASICS

1. Please refer to the official manual of *Activision® Anthology* for Game Boy® Advance to review how to setup and select this game.
2. Hold the L button and press LEFT on the D-Pad to set the length of your rope: In the **A** position, the rope is short, and in the **B** position, the rope is longer. Holding the L button and pressing RIGHT on the D-Pad has no effect.
3. **Game Select.** Hold the L button and press UP on the D-Pad to select a game:
 - Game 1: Sidekick
 - Game 2: Pilgrim
 - Game 3: Cowpoke
 - Game 4: Wrangler
 - Game 5: Top Hand
 - Game 6: Trail Boss
 - Game 7: Rancher
 - Game 8: Cattle Baron(see explanation under “Games”)
4. **To begin play.** Press the SELECT button.
5. **Controls.** Use the D-Pad to move horse and rider up and down on screen. Press the A button to throw the rope.
6. **Scoring.** You score points by roping cattle. Each dogie is worth points, depending on its colour, as follows:
 - Black Angus = 100 points
 - Light Brown Jerseys = 25 points
 - Medium Brown Guernseys = 15 points
 - Dark Red Herefords = 3 points

The numbers on the upper right side of the screen indicate the player's score. The number on the upper left side of the screen indicates the number of dogies which you can allow to stray behind you before the game ends. This number starts at 3 – and decreases by one each time a dogie strays off the left side of the screen. When the last one strays behind your horse, the game is over.

7. **Object of the Game:** To score as many points as possible by roping as many dogies as you can before too many stray behind you.

HOW TO PLAY STAMPEDE™

Climb into your saddle and start ridin'! You'll want to practice playing your horse and rider in the right position to rope and herd those dogies without letting any get by you – and to dodge any surprises on the trail.

To rope, position your horse directly behind the dogie you wish to lasso. The rope will always be thrown directly in front of your horse, and the loop **must** touch a dogie in order to rope him. If you attempt to rope a steer which is too far away or too close, you'll come up empty. When you get more at home on the range, you'll know the right time to throw your rope.

It's impossible to score well if you can't keep the game going long enough to rope a passel of dogies. The only way to do that successfully is to keep the cattle in a herd in front of you. Herding is as important as roping in helping you run up your score.

When you ride just behind one of the dogies, you'll notice he'll speed up and run further out in front of your horse. Since all dogies do not run at the same speed, you will have your work cut out for you to keep them all together and ahead of you.

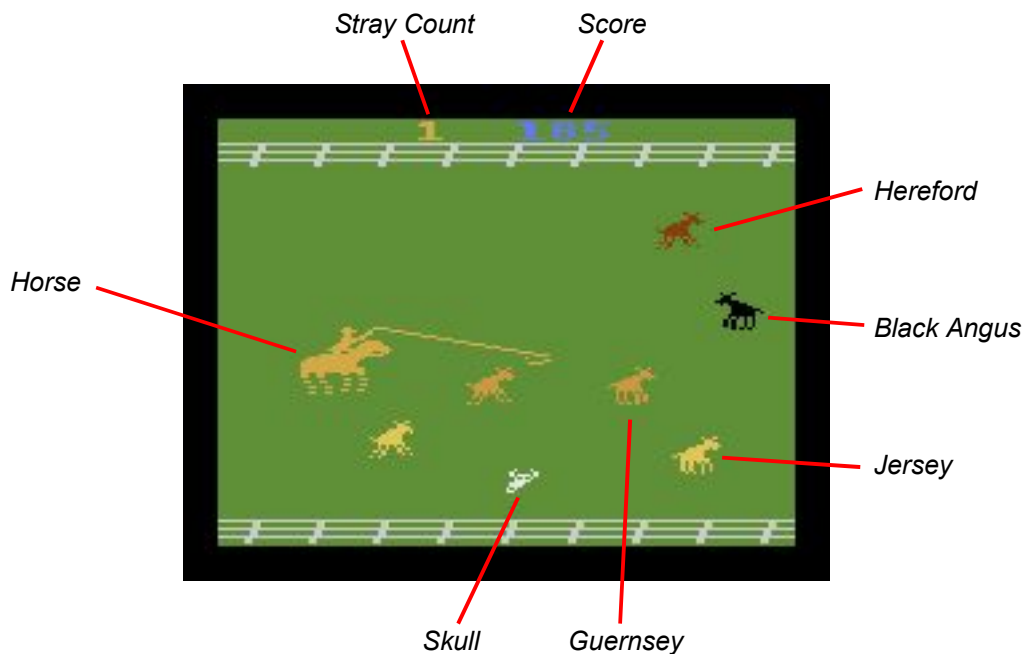

GAMES

Each game of Stampede offers a different pattern, speed and movement of the dogies, providing new challenges every time you play.

GAME ONE / SIDEKICK LEVEL. When the game begins, dogies lope along, gradually running faster as the game progresses. They will run only straight ahead, and they travel in a specific pattern. Dark Red Herefords are first. After you rope these critters, the Light Brown Jerseys appear, followed by the Medium Brown Guernseys. Keep your eyes peeled for an occasional Black Angus.

GAME TWO / PILGRIM LEVEL. Same as Game 1, except all dogies try to avoid your lasso by moving up and down the screen.

GAME THREE / COWPOKE LEVEL. Same as Game 1, but there is no set pattern of appearance of dogies on the screen.

GAME FOUR / WRANGLER LEVEL. Same as Game 3, but all dogies try to avoid your lasso by moving up and down the screen.

GAMES FIVE THROUGH EIGHT. Same patterns as Games 1 through 4, except all dogies start out at a full gallop.

SPECIAL FEATURES OF STAMPEDE™ BY ACTIVISION®

Dangers on the trail. The cattle drives of the Old West had their share of hazards – and Stampede does too. Occasionally, you'll come upon an old bleached skull on the trail, and your horse will rear if you attempt to ride over it. If that happens, some of the dogies you are herding and roping could stray by, so look out and be prepared to ride around the skulls.

There's also a Black Angus who pops up every now and then (worth 100 points if you rope him), and he can be a bum steer. Since he's sitting still and facing you – and can't be herded – he's tough to rope. Worse, if you bump into him, not only will he have strayed out of the herd, but your horse will rear, slowing your pursuit of other dogies.

A well-trained horse. Your pony's no stranger to a roundup. When you throw your lasso, **he won't move.** This keeps you firmly in the saddle – but you can't change your mind and chase another dogie once you've decided to throw your rope.

No time limit. You can keep on ridin' and ropin' as long as your "stray count" (the number on the left side of the screen) is 1 or more. The better you get at roping and herding dogies, the longer your roundup will last.

Increasing your stray allowance: After each 1000 points, you'll notice your stray count will **increase** by one, giving you more of a chance to rope and ride. The number, however, will never get larger than 9.

JOIN THE ACTIVISION® "TRAIL DRIVE"

If you succeed in scoring 3,000 points at Stampede™ by ACTIVISION®, we will enroll you in the Activision® "Trail Drive", and you will receive a special patch.

Should you score a whopping 10,000 points (whew!) a small brand (looks like the head of a steer) will appear at the bottom left of your screen, and the score will "wrap around" to zero.

HOW TO BECOME A CATTLE BARON WITH STAMPEDE™ BY ACTIVISION®

Tips from Bob Whitehead, designer of Stampede.

Bob Whitehead is a Senior Designer at Activision. Before creating Stampede™, Bob designed Boxing and Skiing for Activision.

"If you are a really savvy cowboy, you could probably play Stampede till the cows come home. Strategy, patience, and smart herding and roping are what really count.

"First of all, keep in mind the particular sequences in which the different dogies appear. My advice is to establish a priority for roping the stampeding herd.

"One strategy is to lasso the high-point dogies first, while keeping the darker (low-point) ones herded in front of you. REMEMBER, herding is the most important part of the game. A dogie that is constantly herded will actually get stubborn and become more difficult to rope because he's too close to you; but he won't stray.

"You'll notice that the dogies appear in rows. When you rope the last one of a group of dark red Herefords... get set for some fast action, 'cause there's trouble ahead!

"Drop me a line. I'd like to hear about your Stampede Trail Drives... Happy Trails! God Bless!"



You are alone in space. A critical and difficult mission awaits you. Carefully read these instructions and commit them to memory. Then, study "The Power of StarMaster" (in Appendix A, page 283). It will help to instruct you in the ways of advanced space combat. And then, perhaps someday, **you** can attain the level of Supreme StarMaster.

STARMASTER™ BASICS

PILOT BRIEFING

"You must protect your starbases by destroying all invading enemy starfighters before they destroy you or your starbases. You must accomplish your mission quickly, using the least amount of energy, sustaining the least damage. Succeed, and you will be rewarded. Fail, and you will be destroyed. The destiny of the galaxy is in your hands."

1. Please refer to the official manual of *Activision® Anthology* for Game Boy® Advance to review how to setup and select this game.
2. **Is it important NOT to toggle the difficulty switches during game play.** In other words, do not press LEFT or RIGHT on the D-Pad while holding the L button.
3. Select your game level as follows:
 - a. Hold the L button and press DOWN on the D-Pad to call up the Galactic Chart (see illustration next page).
 - b. Consult the first line of your Mission/Attack Control Computer (MACC) information at bottom of screen.
 - c. Hold the L button and press UP on the D-Pad to select the game level. The initial letter of game level will appear on the first line of the MACC information. Game levels vary based on the number, speed and accuracy of enemy starfighters, and the number and speed of meteors encountered in space.

GAME LEVELS

	Number of Enemy Fighters	Meteor and Enemy Speed
E: Ensign	9	Nominal
L: Leader	17	1.5 X Nominal
W: Wing Commander	23	2.0 X Nominal
S: StarMaster	31	2.5 X Nominal

4. **The Adventure Begins.** Press the SELECT button to start your mission. Your ship will be cruising through an empty sector of the galaxy. Now, you must seek out the enemy and race at warp speed to meet and destroy them.

MISSION OPERATIONS

During the course of your mission, you will make use of four distinct modes of operation:

- Galactic Chart Analysis
- Warp Travel
- Engaging the Enemy
- Docking with a Starbase

GALACTIC CHART ANALYSIS

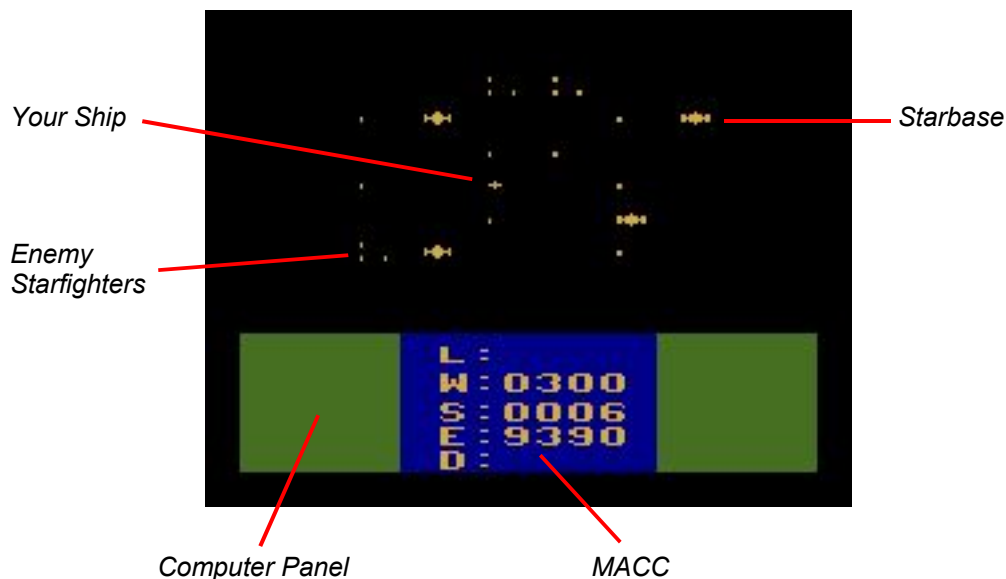

Display your ship's Galactic Chart by holding the L button and pressing DOWN on the D-Pad. The chart displays three types of information:

1. **Galactic Radar/Sector Analysis.** Displays the relative locations in the galaxy of your ship (indicated by a +); your starbases (shown as large oval dots); and enemy starfighters (shown as white "blips" on the radar). There are 36 sectors of the galaxy (a 6x6 matrix) shown on the radar.
2. **Mission/Attack Control Computer (MACC) Information.** Displayed below the Galactic Chart:

E or **L** or **W** or **S**: Game level (see page 221).

W: Energy required to warp between sectors of the galaxy.

S: Stardate (elapsed time of your mission).

E: Energy remaining (your ship starts with 9999 units).

D: Damage Control Status (see discussion next page).

3. Color of Computer Panel Display:

Green: You are in or flying to an empty sector.

Red: You are in or flying to a sector occupied by enemy starfighters.

Blue: You are in or flying to a sector occupied by a starbase.

In Galactic Chart/Sector Analysis your object is to locate enemy starfighters – or your starbases. After consulting MACC, select a sector of the galaxy to which to warp, to either engage the enemy or dock with a starbase for refueling and repairs.

Select a sector of the galaxy by pressing UP, DOWN, LEFT or RIGHT on the D-Pad, which moves a cross on the Galactic Chart display. Place the + in the sector of the galaxy to which you wish to travel.

Press the A button to begin Warp travel to the selected sector.

WARP TRAVEL

In this segment of your mission, you will be travelling at warp speed from one sector of the galaxy to another. Be alert to meteors which enter your path. Use your D-Pad to steer around them (press any direction on the D-Pad to maneuver) or destroy them with your laser cannons (press the A button to fire). Each meteor that hits your ship drains 100–500 units of energy from your shields, and could result in even greater damage to your ship.

During warp travel, MACC will provide only Energy and Damage Control Status.

ENGAGING THE ENEMY

When you enter an enemy sector, your ship's laser gunsight will begin to flash, indicating the presence of enemy starfighters. Your object is to destroy all enemy starfighters in the sector, in the fastest time, using the least amount of energy and avoiding damage to your ship.

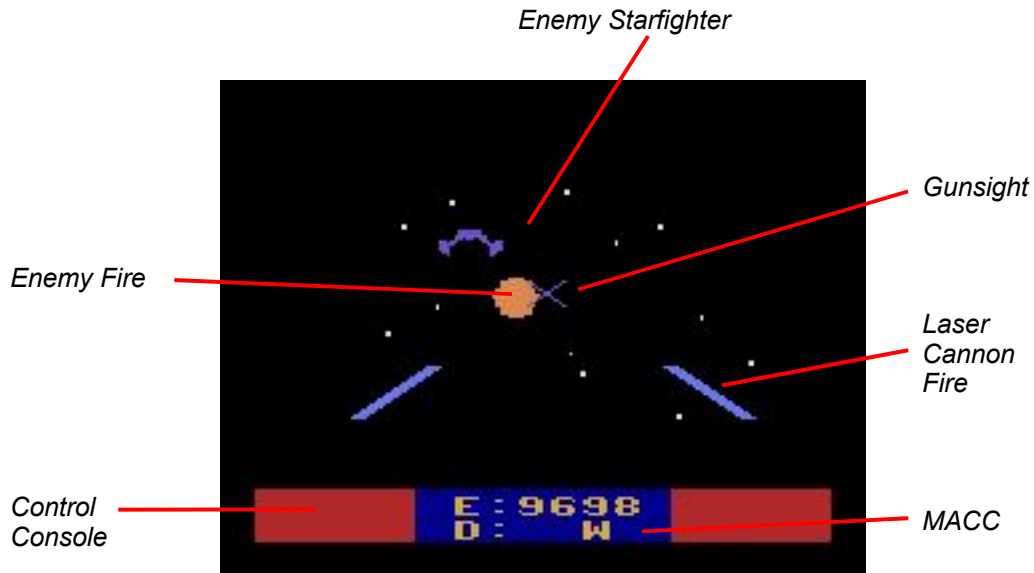

Press the A button to fire your laser cannons. A red explosion occurs when an enemy ship is destroyed. A blue explosion occurs when you destroy incoming enemy fire. A **yellow** explosion results when your ship is hit by enemy fire. Each firing of your laser cannons requires 100 units of energy; each time you are hit by enemy fire, you lose between 100 and 500 units of energy, depending on the severity of the damage.

When all the enemy ships in a sector have been destroyed, your control console will turn from red to green. You should then refer to your Galactic Chart (hold the L button and press DOWN on D-Pad) to seek out more enemy or locate your starbases.

While engaging the enemy in battle, MACC will display **only** Energy and Damage Control Status. Monitor Damage Control to determine when damage occurs, as follows:

Damage Control Status (D: LSWR)

- L: Laser cannons destroyed.** You cannot fire at the enemy or meteors.
- S: Shields destroyed.** Your ship is defenseless. One more hit from enemy fire or collision with a meteor during warp travel will destroy your ship and end the game.
- W: Warp engines are damaged.** Your ship will use twice as much energy during warp travel. Watch energy reserves.
- R: Radar destroyed.** You can no longer spot enemy fighters on the Galactic Chart. Your starbases will continue to appear.

Whenever damage occurs, you will hear an explosion, whether you are monitoring your Galactic Chart or viewing the space around you.

Energy Reserves

MACC will activate the energy reserve alarm (a yellow hazard light on the control panel) when energy drops below 1000 units. If your ship runs out of fuel, your mission cannot be continued, and the game is over.

To repair damage and/or refuel, you must reach one of your starbases and dock.

DOCKING WITH A STARBASE

To reach a starbase for docking, call up your Galactic Chart (see Galactic Chart Analysis), select a sector of the galaxy in which a starbase is located, and press the A button to warp to the starbase sector.

To dock, use the D-Pad to pilot your ship until your ship's sights connect with the orbiting starbase at its closest approach.



Once docked, your ship's energy will be completely replenished and all damage will be repaired. You will then be prepared to continue your mission to destroy the enemy.

When a Starbase is Destroyed

Enemy starfighters are constantly trying to surround and destroy your starbases. Only you can prevent this from occurring. When the enemy succeeds in destroying a starbase, an explosion is heard (no matter where your ship happens to be at the time), and the starbase disappears from the Galactic Chart.

THE MISSION ENDS

When all enemy ships are destroyed **or** your ship is destroyed **or** your ship runs out of energy, your mission is over.

Call up the Galactic Chart (hold L button and press DOWN on D-Pad) and review your Mission Evaluation (score).

MISSION EVALUATION

When your mission is over, the top line of MACC will display an evaluation of your performance next to the game level indicator. You must call up the Galactic Chart (hold the L button and press DOWN on the D-Pad) to review your performance.

Your score is determined by how efficiently you complete your mission. You are awarded 100 points for each enemy starfighter you destroy. You are penalized:

- 500 points for each starbase destroyed by the enemy.
- 100 points for each time you dock for refueling and repairs.
- 1 point for each Stardate elapsed.

These bonus or penalty points are added to or deducted from a base score set at the beginning of each mission, as follows:

Game Level	Base Score
Ensign	3100
Leader	4300
Wing Commander	5700
StarMaster	6900

Example: At Leader level, you destroy all enemy fighters (17) in 83 stardates, docking once and losing one starbase. Your score:

Base Score	4300
Credit for Enemy Destroyed	+ 1700
Deduct for Stardates	- 83
Deduct for Docking	- 100
Deduct for Loss of Starbase	- 500
FINAL SCORE	5317

The maximum score for each game level is as follows:

Game Level	Maximum Score
Ensign	4,000
Leader	6,000
Wing Commander	8,000
StarMaster	10,000

ENTER THE "ORDER OF THE SUPREME STARMASTER"

Any Mission Evaluation score which meets or exceeds the standards set below qualifies you to be inducted into the **"Order of the Supreme StarMaster"**.

Game Level	Qualifying Score
Ensign	3800
Leader	5700
Wing Commander	7600
StarMaster	9000

If you qualify, we will enroll you and give you a special emblem of achievement. *(There are four emblems to collect in all, one for each game level.)*

"THE POWER OF STARMASTER™"

A special training manual accompanies these instructions. It contains invaluable information, insight and guidance to help you understand the special features of StarMaster™ by Activision®, and the skills and techniques which can help you achieve the "Order of Supreme StarMaster™." *(You will find this guide in Appendix A, on page 283)* Read it thoroughly, and practice its principles. With proper dedication and training, you, too, can have "The Power of StarMaster™".



Now, you'll never have to wait for a court again. With Tennis by ACTIVISION®, you can enjoy the challenge and excitement of tennis right on your home TV. But before you start, take a minute and read these important instructions. They'll help you to really enjoy all the special features of the game. In no time you'll be playing like a pro!

TENNIS BASICS

1. Please refer to the official manual of *Activision® Anthology* for Game Boy® Advance to review how to setup and select this game.
2. A two-player game requires the use of a second Game Boy® Advance unit connected with a Link Cable. Refer to the official manual for details on how to set this up.
3. **Difficulty Settings.** Hold the L button and press LEFT on the D-Pad to set the difficulty or handicap for player 1 (orange player). Likewise, hold the L button and press RIGHT on the D-Pad to set the difficulty or handicap for player 2 (blue player). The effect is the same in both cases:
 - A – The widest-angle shots are eliminated.
 - B – Players can hit shots at a wide variety of angles (some of them very sharp).
4. **Game Select.** Hold the L button and press UP on the D-Pad to select your run:
 - Game 1: You against the Activision® computer pro (full speed).
 - Game 2: You against a friend (full speed).
 - Game 3: You against the Activision® computer pro (slow motion).
 - Game 4: You against a friend (slow motion).

NOTE: In games 1 and 3, you are the orange player, and the computer pro is the blue player.
5. Player 1 uses the D-Pad and A button to play in Games 1 to 4. Player 2 uses the D-Pad and A button on his own Game Boy® Advance unit (Game 2 and 4 only).
6. **To begin play or start a new set.** Press the SELECT button. The orange player begins serving each set. Players will change sides following each odd game. Server is shown with bouncing ball.
7. **How to play.** Pressing LEFT on the D-Pad moves your player left, and pressing RIGHT moves him right. Press UP or DOWN to move to and from the net. Before each serve, you can only move to the right or left. During game action, you can move in all directions.

8. **To serve.** Use the D-Pad to position your player, then press the A button to serve. The A button is used **for serving only**. After serving, players will swing automatically if they are in position to return a shot.
9. **Scoring** is the same as in real tennis: 15–30–40, "deuce" at 40–all, and "ad in" or "ad out" following "deuce". The first player to win at least 6 games and be ahead by two games wins the set. If players tie in games at 6–6, the score returns to 0–0, and the first player to go two games ahead wins the set. One bell sounds after each point, three after each game, and six at the end of each set. Each player has his own bell tone.

SPECIAL FEATURES OF TENNIS BY ACTIVISION®

SERVING AND VOLLEYING

You can serve to any part of the court and your first serve is always "in". Also, you can never hit the ball to long (beyond your opponent's baseline or sidelines) or too short (into the net). Just like in real tennis, when you're volleying at the net, you'll notice that your shots don't travel as far as they do when you hit them from the baseline. Also, you'll be able to hit your most sharply-angled shots while playing at the net.

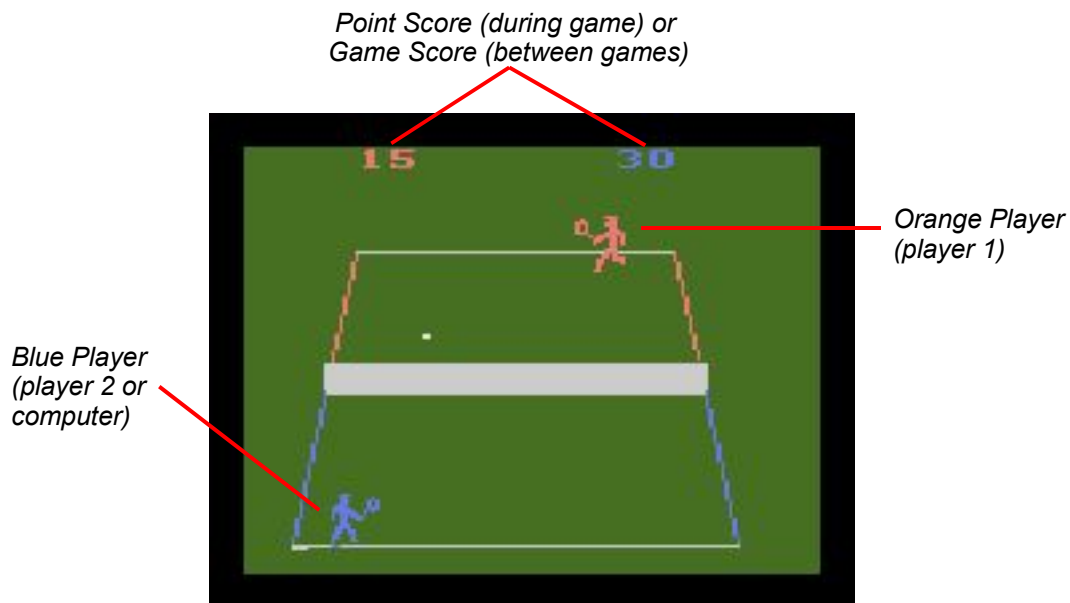

PLACING YOUR SHOTS

Just as in real tennis, in Tennis by ACTIVISION® you can aim and "place" the ball depending on how you hit it. The angle of your shot is controlled by **where** you hit the ball on your racket. If you hit the ball in the center of the racket, your shot will go straight forward. The closer you hit the ball to the edge of the racket, the sharper the angle will be in the direction your racket is facing. But you'll need to be careful. It's easy to attempt a sharply-angled shot and miss the ball entirely. There are a wide variety of angles to hit the ball. Experiment with them and you'll soon be able to precisely aim your shots and hit them out of reach of your opponent.

GETTING THE FEEL OF TENNIS BY ACTIVISION®

Once you understand the game's basics, we suggest you start off with game 3 or 4 and play in slow motion for a while. Put the left and right difficulty switches in the **B** position (hold the L button and press LEFT and RIGHT on the D-Pad to do this). You'll soon get the feeling of the court, when to rush the net, when to lay back and play the baseline, and how the ball reacts when it's hit from various positions on your racket. If the wide-angle shots are too much at first, move either or both difficulty switches to the **A** position while you practice. After you've gotten a little confidence, take on the Activision® computer pro or a friend at full speed (Game 1 or 2) with full wide-angle shot capability (difficulty switches on **B** setting). You'll find it quite a challenge.

HOW TO BECOME A PRO AT TENNIS BY ACTIVISION®

Tips by Alan Miller, designer of Tennis.

Alan Miller is a Senior Designer at Activision. A fierce video game competitor, he's the designer and undisputed champion of Checkers and Tennis by ACTIVISION®.

"My Activision® Tennis, like real tennis, puts a premium on anticipation, reflexes, and conditioning. You really have to stay on your toes, try and anticipate where your opponent's shot will land, and get in position to return.

"Practice moving quickly to the area where you think your opponent's shot will go. If you can do that, then you'll get a jump on placing your shot out of your opponent's reach.

"For an extra tough challenge, try to serve and volley against the computer with the difficulty switches set on **B**. Hit a sharply-angled serve off the edge of your racket to either the right or left side, then move quickly about two-thirds of the way to the net.

"If you've anticipated properly, you can nail his return with a cross-court volley for a winner. But, guess wrong and he's passed you. This strategy demands a high level of concentration, razor-sharp reflexes, and lots of practice.

"But you know the old saying, practice makes perfect. So, keep at it, good luck and have a great game. Drop me a line and let me know how you do. I'd love to hear from you."



Thwocker™ is an unreleased prototype originally programmed by Charlie Heath for Activision at their East Coast Design Center. It was recently discovered by a retro-gaming fan who found a copy at a local thrift store. While Thwocker™ looks fairly polished and complete, it reportedly is only around 80% complete. Which is unfortunate as it's a great looking 2600 game with interesting gameplay to boot.

GAMEPLAY

For Thwocker, music is his life. Litterally. He wants nothing more than to complete his symphony. To find the perfect notes, Thwocker will have to navigate through a cacophony of noisome instruments. It's up to you, Maestro!

In Thwocker™, the object is to gather the musical notes in the correct order as indicated in the status area, while also avoiding the flying musical instruments.

Once you have collected the proper musical notes, grab the large note at the top of the level. At that point, a tune will begin playing and you can now grab all the remaining musical notes, as well as the musical instruments.

THWOCKER™ BASICS

1. Please refer to the official manual of *Activision® Anthology for Game Boy® Advance* to review how to setup and select this game.
2. **Game Select.** Hold the L button and press UP on the D-Pad to select a game. There are 16 different game levels in Thwocker™. The higher the number, the more difficult the level.
3. To begin play, press the SELECT button. You can reset the game at any time this way.
4. **Movement.** The D-Pad is used to control Thwocker's bounce height and direction:
 - Pressing LEFT or RIGHT moves Thwocker in the corresponding direction
 - Pressing UP increases Thwocker's bounce height.
 - Pressing DOWN or the A button decreases the height of Thwocker's bounce.

Your goal is to find and grab the musical note identical to the one at the bottom right of the screen. Once a note is taken, a new note will appear. Catch all the notes to write your symphony.

5. **Scoring.** You score points by catching the right notes. After your symphony is completed, you also score points when bouncing on dangerous instruments.

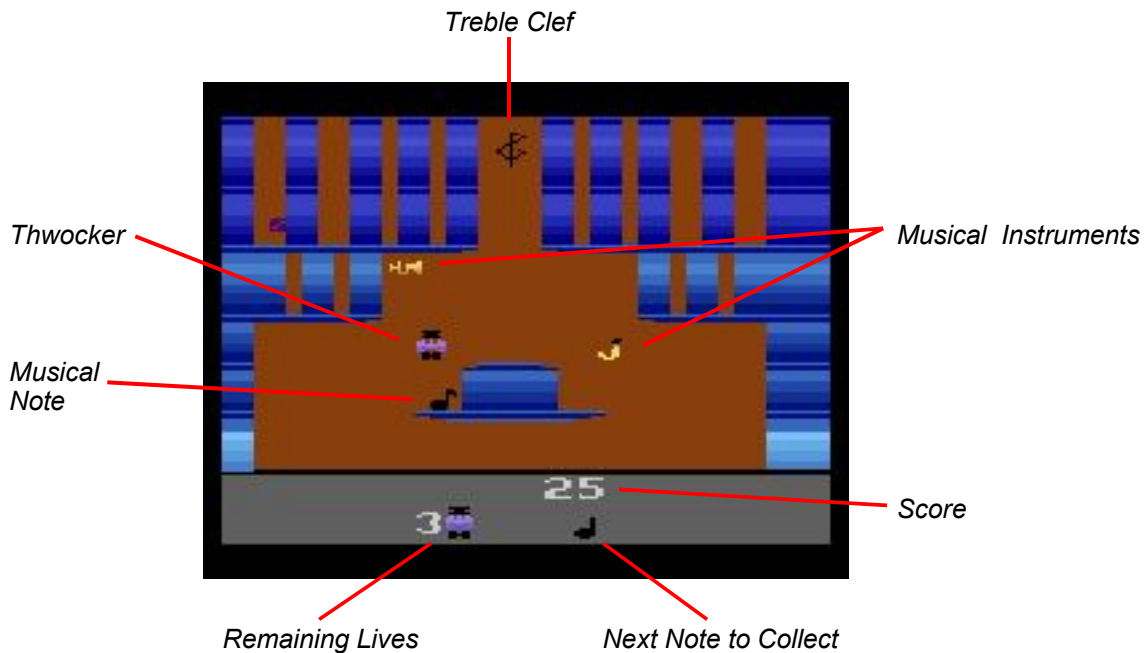

SPECIAL FEATURES OF THWOCKER™ BY ACTIVISION®

Avoid the Instruments. All moving instruments in the level will take a life from Thwacker if they touch him. You'll have to use the utmost care in bouncing the Maestro through the level.

A Bigger Bounce. To get Thwacker to bounce higher, you press UP on the D-Pad. But, you'll have to time your press with Thwacker's bounce if you want to get the most height.

The Treble Clef. Once all notes to the symphony are caught, the last symbol needed is the Treble Clef (which looks similar to an ampersand). It always appears at the very top of the game level. This usually means a very long and dangerous climb back to the top!

A Complete Symphony. Once Thwacker has grabbed the Treble Clef, his symphony is completed – his finished music plays at the bottom of the screen. You've completed the level! Well done! You can now bounce on your instrumental enemies and destroy them.

Continuing On. Once you have a completed symphony, your game is over. Try playing again on a harder level to see if you're up to the challenge.

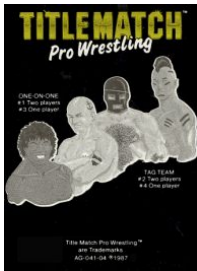

TITLE MATCH PRO WRESTLING™

1 or 2 players (Link Cable) ©1987, 2002 Skyworks Technologies Inc.

TONIGHT'S THE NIGHT

"...the screams of the crowd shake the arena as the Title Belt contenders circle one another. Mad Dog makes the first move smashing his fists into Skin Head's chest who gasps for air, then retaliates with a shin cracking kick. Mad Dog growls and grabbing from behind drags Skin Head across the ring whipping him around in an airplane spin; letting go so he flies into the ropes and bounces back to meet Mad Dog's concrete forearm across his neck... a perfectly executed clothesline. Wasting no time Mad Dog elbow drops him. Skin Head's face winces in pain as he fights his way up and staggers to his corner to tag his partner in. Big Chief takes the tag, grabs Mad Dog lifting him over his head and body slams him into the mat. Mad Dog's stunned, he's not getting up. Big Chief, looking for the pin, climbs the ropes for a dive. As he lunges into the air, Mad Dog scrambles to his feet and Big Chief's sweaty red skinned body splatters on the empty mat..."

TO BEGIN

1. Please refer to the official manual of *Activision® Anthology* for Game Boy® Advance to review how to setup and select this game.
2. A two-player game requires the use of a second Game Boy® Advance unit connected with a Link Cable. Refer to the official manual for details on how to set this up.
3. Hold the L button and press UP on the D-Pad to go to the selection screen. The number on the scoreboard displays the type of match currently selected:
 - 1 one on one
 - 2 tag team match (two on two)
 - 3 one on one computer wrestler (you against the computer)
 - 4 Tag Team Match – computer wrestlers (your team against the computer's team)



Holding the L button and tapping UP on the D-Pad will cycle you through the match selections. Once you have selected a match, choose your wrestlers beginning with player 1 (the person holding the Game Boy® Advance unit which carries the game cartridge). Move the D-Pad to highlight your selection and then press the A button. Once player 1 has selected a wrestler, it is player 2's turn. In a tag team match, this selection occurs twice. The contenders are from left to right:

Mad Dog – From Mad Dog, Louisiana, and weighing in at a whopping 390 lbs., this redneck husky vows to "chew up and spit out" anyone who tries to tangle with him.

Skin Head – Weighing in at 265 lbs., from Cowpoke, Idaho, this farmboy was brutally forced to shave his head after losing in a cow-tipping contest. To overcome his humiliation, Skin Head turned to wrestling at the age of 9, and today is one of the most feared wrestlers of our time.

Mr. Mean – Currently weighing in at 320 lbs., from Hoboken, New Jersey, Mr. Mean acquired virtually all of his early training on the streets, defending himself against *slime*.

Big Chief – One part Apache and one part hulk, from Big River, Utah, he is merciless at 420 lbs. Big Chief pow wow doesn't miss a trick – he will crush you without a second's thought.

4. Once contenders have been chosen, the arena screen is displayed and the match can begin. At any point during gameplay, pressing the SELECT button will restart the currently selected match.

TAKING THE BELT

Each wrestler's strength is displayed by power bars on the scoreboard. The upper bar represents the strength of wrestler #1 (player 1), and the lower bar represents the strength of wrestler #2 (player 2 or computer). Your challenge will be to sustain your strength while depleting your opponent's. **Strength, used in combination with skillful maneuvering will enable you to pin your opponent.** Next to each wrestler's power bar is a digit representing how many times the opposition has fallen. Pinning your opponent for 3 counts will constitute a fall. The rule for winning a match is best out of three falls.

YOUR CONTROLS

There are two modes of control used during gameplay. The first is "**movement mode**", which is simply moving the D-Pad in any desired direction. Your wrestler's movement or pattern will correspond to that of your D-Pad. The second is "**attack mode**". To switch from *movement mode* into *attack mode* you must first release the D-Pad. Then press the A button and use one of the four directions on the D-Pad to execute a move. To use *attack mode* in succession, you must release both the A button and the D-Pad and then press the A button and move the D-Pad again. The following instructions will refer to *attack mode* as either "**attack mode up, down, right or left**".

SOFTENING YOUR OPPONENT

Once the match begins, your wrestlers can walk around the ring in *movement mode*. Make your wrestler punch with **attack mode up**, and kick with **attack mode down**. You can "soften" your opponent with these moves by knocking down his strength, while maintaining your own.

THE BEAR HUG...

With the exception of punching and kicking, you must first grab your opponent into a *bear hug* before making a move against him. Do this by moving your wrestler right next to his opponent, release the D-Pad, and in *attack mode*, grab by directing the D-Pad toward the opponent. (To release your opponent you must re-activate *attack mode*, this time directing the D-Pad toward your own wrestler). Once you have captured your opponent in a bear hug, you can drag him around the ring in *movement mode*. Using **attack mode down**, *canvas slam* your opponent.

“AROUND HE GOES...”

While you have him in a bear hug, direct the D-Pad towards your opponent in *attack mode* to swing him into an *airplane spin*. Switch to *movement mode* by releasing the A button and throw your opponent. You can swing your opponent just a little to bounce him off of the ropes or swing him around many times and then let go to send him bouncing into the ropes and then flying back across the ring! When your opponent bounces off the ropes, get in his path and press the A button before he passes you to *clothesline* him and knock him to the canvas.

NOTE: When *caught* in a bear hug, you must use **Muscle Mode** to generate the extra power needed to escape. See **Muscle Mode**.



“HE'S FLYING HIGH!”

To *power lift* your opponent, get him into a bear hug and use **attack mode up**. Once he is overhead, use *movement mode* to carry your opponent around the ring. Using **attack mode up**, you can *back drop* and pin your opponent. Or use **attack mode down** for a *body slam*. Carry your opponent to one of the top corners of the ring and use **attack mode down** to throw him out of the ring.

“HE'S DOWN...”

With your opponent down, in *movement mode* you can walk freely around the ring. Position your wrestler right next to his opponent and use **attack mode up** to power lift him, or use **attack mode left or right** to grab him into a bear hug. Use **attack mode down** to *elbow drop* and pin your opponent.

NOTE: When a wrestler is down, he can use **Muscle Mode** to generate the additional strength needed to get back up. See **Muscle Mode**.

“HE'S UP ON THE ROPES!”

If your opponent is down and you are away from him at the very top or very bottom of the ring, you can climb onto the ropes using **attack mode up**. Once on the ropes, pressing LEFT or RIGHT in *movement mode* allows you to walk back and forth. Use **attack mode down** to climb off of the ropes, or use **attack mode up** to do a *rope dive* and pin your opponent.

SWITCHING WITH TAG TEAM PARTNERS

When competing in a tag team match, move your wrestler to his corner at the bottom of the ring and use **attack mode down** to switch with your tag partner. *A good time to do this is when your strength is down, but remember that your partner must be at maximum strength in order to switch. You can tell that your partner's strength is up by walking near your corner. If your partner attempts to follow you, then he has fully regained his strength.*

MUSCLE MODE

When your opponent is down or in a bear hug, he can escape by putting "**Muscle Mode**" into action. Muscle Mode is executed by rapidly tapping LEFT and RIGHT on the D-Pad. Jiggling the D-Pad provides extra strength to be used in combination with the wrestler's already existing strength. The following are situations in which you will find it necessary to utilize *Muscle Mode*:

- When your opponent has gotten you into a bear hug – If your strength combined with your extra power from using *Muscle Mode* exceeds the strength of your opponent, you can break away. **Example:** if you have more strength than your opponent and he grabs you, minimal muscle will be needed for you to break away.
- To get back up when you are down on the canvas – If you already have at least half of your strength, little muscle is needed to get back up. With less than half your strength available, you must work harder in *Muscle Mode* to get back up.
- When you are pinned – If your strength combined with the extra muscle generated by using *Muscle Mode* exceeds that of your opponent, you will succeed in escaping.
- When you have your opponent pinned – In this situation, *Muscle Mode* is used offensively. This is a *Muscle Mode* competition, in which you, the aggressor, are trying to maintain your pin for three seconds, while your opponent is trying to escape.

SOME STRATEGIC ADVICE FROM THE EXPERTS...

- Keep in mind that certain offensive moves, such as power lifting, or holding your opponent in an airplane spin for an extended period of time will use up a lot of your own strength, while increasing your opponent's. Try to use less expensive moves such as punching and kicking to soften your opponent, so that when the time comes, you will have enough strength to pin him.
- Pin your opponent unexpectedly to get a head start in the *Muscle Mode* competition.
- In tag team competition, if you know that your opponent's tag partner is weak, throw your opponent out of the ring. This will force his partner into the ring, allowing you to take advantage of the competition's weakened condition.
- In tag team competition, if you know that your opponent is weak, guard his corner to prevent him from switching with his tag team partner.

POSITION	JOYSTICK CONTROL MODE				
	Movement Mode	Attack Mode UP	Attack Mode DOWN	Attack Mode RIGHT	Attack Mode LEFT
Free	Walk Around Ring	Punch	Kick	Grab – Bear Hug	Grab – Bear Hug
Holding Opponent in Bear Hug*	Drag Him Around Ring	Power Lift	Canvas Slam	Towards Opponent – Airplane Spin	
				Away From Opponent – Let Go of Him	
Holding Opponent Overhead	Carry Him Around Ring	Back Drop	Body Slam		
Swinging Opponent – Airplane Spin	Throw into Ropes	Continue Airplane Spin	Continue Airplane Spin	Continue Airplane Spin	Continue Airplane Spin
Opponent Down*	Walk Around Ring	Power Lift	Elbow Drop and Pin Opponent	Grab – Bear Hug	Grab – Bear Hug
Up On Ropes	Walk Around Ropes Left, Right	Rope Dive	Climb Down From Ropes		
Opponent Pinned**	Muscle Mode	Get Up	Get Up	Get Up	Getp Up

* Opponent can use Muscle Mode

** Both players can use Muscle Mode



NOTES FROM A TOP GUNNER

by Dan Kitchen, designer of TOMCAT – THE F-14 FIGHTER SIMULATOR™

"I've always been fascinated by the technology of military fighter aircraft and admired the courage of the pilots who routinely defy the odds in the skies above. I've tried to incorporate the spirit and challenges of actual fighter jet combat into this game and I've consulted with many actual fighter pilots to ensure the accuracy of TOMCAT – THE F-14 FIGHTER SIMULATOR™.

"I owe many thanks to my brother and co-designer Steven Kitchen, without whose help we would not have made it off the flight deck.

"Here's thumbs up in your quest for Top Gun!"

FLIGHT MANUAL FOR TOMCAT - THE F-14 FIGHTER SIMULATOR™

TO BEGIN:

- 1) Please refer to the official manual of *Activision® Anthology* for Game Boy® Advance to review how to setup and select this game.
- 2) Press the SELECT button to begin game. At this point the cockpit controls of the F-14 TOMCAT will light up and you will see the deck of the aircraft carrier U.S.S. Enterprise through your cockpit canopy.

Your TOMCAT F-14 FIGHTER SIMULATOR™ features an intelligent reset function to guard against resetting the game by mistake. If you're in the middle of a game and you hit the SELECT button, you must hold it down for at least 2 seconds before a new game will start.

READY FOR FLIGHT

You're at the controls of your F-14 TOMCAT fighter at 1900 hours, waiting to receive authorization for take off from the U.S.S. Enterprise. During your mission you'll face the enemy's most challenging air combat forces. At your disposal are the state-of-the-art computer controls and weapons systems of one of the U.S. Navy's most sophisticated fighters: the F-14 TOMCAT.

Your first take-off will be during daylight hours. But by the time you receive order to return to the U.S.S. Enterprise, you'll notice the approach of dusk and you'll have to successfully perform a most dangerous nighttime landing on the aircraft carrier. Your next mission will be a night mission. You'll have to take off, engage in combat and return to the Enterprise in total darkness, relying more on your computer control systems to see you through safely.

After each successful return to the aircraft carrier, or if you crash or are shot down, you'll receive a MISSION RATING score (from 0 to 9) that is based on your flying skills, the number of weapons fired, and kills. There are four phases of flight operation: LAUNCH, FLYING, COMBAT, and LANDING.

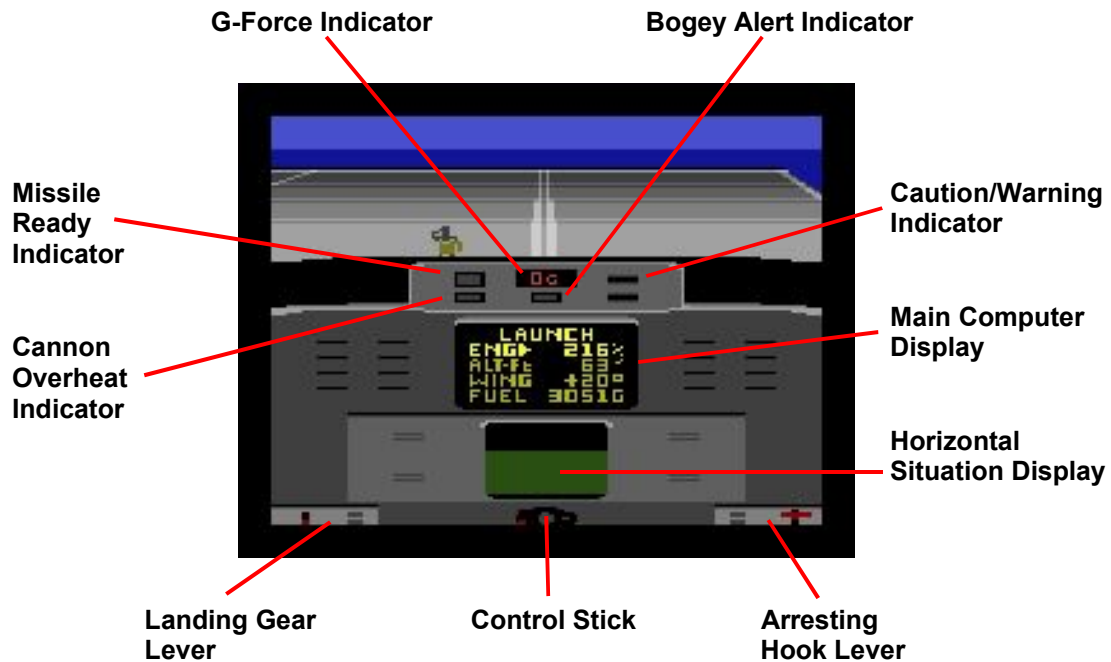

CONTROLS

TOMCAT THE F-14 FIGHTER SIMULATOR™ uses the D-Pad and almost all the buttons of your Game Boy® Advance system.

Reset (SELECT button):

- Starts game.
- Enters select mode from THREAT screen.

Select (Hold L button and press UP on D-Pad):

- Cycles through computer display screens.

Right difficulty (Hold L button and press RIGHT on D-Pad):

- Raises / lowers arresting hook.

Left difficulty (Hold L button and press LEFT on D-Pad):

- Raises / lowers landing gear.

Control stick forward (Press UP on D-Pad):

- Dives aircraft.
- Moves highlight when in select mode.
- Increases thrust when the A button is pressed.

Control stick back (Press DOWN on D-Pad):

- Climbs aircraft.
- Moves highlight when in select mode.
- Decreases thrust when the A button is pressed.

Control stick right (Press RIGHT on D-Pad):

- Banks aircraft to the right.

Control stick left (Press LEFT on D-Pad):

- Banks aircraft to the left.

Control stick fire button (Press the A button):

- Fires weapons when THREAT screen is up.
- Chooses options when in select mode.

LAUNCH

You're on the flight deck of the U.S.S. Enterprise, waiting for your F-14 TOMCAT to be fueled and readied for take-off. After your fuel reaches its total capacity of 3080 gallons and the angle of your wings opens to 20°, the FLIGHT DECK OFFICER (in the yellow jacket) will come out to signal you to move onto the carrier catapult. Press and hold down the A button and press UP on the D-Pad to increase engine thrust. When you're locked on to the catapult, the F.D. OFFICER will wave his hand in a circular motion to indicate that it's time to throttle up. Press and hold down the A button and press UP on the D-Pad until the ENG% indicator on your MAIN COMPUTER DISPLAY shows that your engine has reached its full afterburner thrust to 216%. The F.D. OFFICER will salute you, indicating that you are "go for launch" after which you'll be automatically catapulted from the flight deck. After you clear the flight deck, you'll hear the crash warning klaxon horn. Press DOWN on the D-Pad to raise your nose (Angle of Attack) and increase altitude. You will hear this warning sound whenever you are flying below an altitude of 500 feet with the aircraft in a diving position. On launch remember to raise your landing gear by holding the L button and pressing LEFT on the D-Pad.

FLIGHT

Once you're airborne, your MAIN COMPUTER DISPLAY will automatically switch from the LAUNCH screen to the STATS 1 screen, which will show your **SPEED** (measured in mach), your **ALT**itude (measured in feet from sea level: 0'–999' when below 1000' or 1K'–56.0K' when above 1000'), your nose **Angle Of Attack** (from -50° to +55°), and your **ENGINE** % of thrust (from 0% to 100%, 200% to 216% for afterburners).

Holding the L button and pressing UP on the D-Pad will switch your MAIN COMPUTER DISPLAY to show various information screens describing the condition of your aircraft. For example, STATS 2 shows your **WING** angle (from +20° to +68°), your **ALT**itude, your compass heading (**C-HDG**, 0° to 358°), and the amount of **FUEL** remaining.

To increase or decrease your engine thrust, you must press and hold the A button and press either UP or DOWN on the D-Pad. Pressing UP increases engine thrust, pressing DOWN decreases thrust. When you are controlling engine thrust, the STATS 1 screen appears automatically. The only time in which you are unable to change thrust is then the THREAT screen is visible on the computer display.

To manoeuvre the aircraft simply press UP, DOWN, LEFT or RIGHT on the D-Pad. Pressing DOWN will raise your nose **Angle Of Attack**, making the aircraft climb. Pressing UP will reduce the nose **Angle Of Attack**, making it dive. Pressing LEFT or RIGHT will bank the aircraft. At the altitude of 5000 feet you will hear a signal indicating that operating altitude has been reached. The enemy aircraft will not engage before you have reached this altitude. When your aircraft crosses the sound barrier (1.0 Mach) you will hear a distant sonic boom.

COMBAT

For air combat, your F-14 TOMCAT is supplied with a sophisticated computerized defense system, machine guns, and three types of air-to-air missiles.

OFFENSIVE WEAPONS AND MANEUVERS

When an enemy aircraft, or BOGEY, enters your air space, the THREAT screen will automatically appear on your MAIN COMPUTER DISPLAY. The DETAILED DATA DISPLAY (DDD) screen will also appear on the HORIZONTAL SITUATION DISPLAY to show the exact location of the enemy aircraft. The BOGEY will appear as a flashing blip on this top view display.

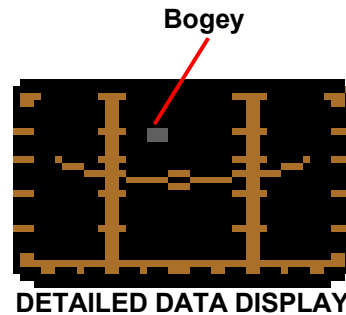

The THREAT screen shows the condition of both your offensive and defensive weapons systems. You can bring the THREAT screen up at any time while you're in flight by holding the L button and pressing UP on the D-Pad until the THREAT screen appears.

On your THREAT screen:

- RNG** shows the distance of the enemy from your F-14, measured in feet.
- or **KILLS** will show the number of enemy aircraft shot down.
- AIM** indicates the type of missile you have ready.
- EC-M** shows whether your counter measures are operating.
- M-61** indicates the on/off condition of your machine gun.

Each time a new BOGEY enters your air space the klaxon horn sounds, the THREAT screen appears and the BOGEY ALERT INDICATOR will flash. The HEADS UP DISPLAY (HUD) will also appear on your visual screen. Through the threat screen you can arm your F-14 with missiles or machine guns and fire them only when the THREAT screen is up.

To choose a weapon, simply press the SELECT button to enter the select mode (be careful not to hold the SELECT button for more than 2 seconds, since this will reset the game). On launch your F-14 is ready and armed with an **AIM 54** missile.

You can choose between selecting a missile type, turning on/off your Electronic Counter Measures (**EC-M**), and turning on/off your M-61 machine guns. Pressing UP or DOWN on the D-Pad will highlight **AIM-**, **EC-M**, or **M-61**. Pressing the A button will select one of these options.

Pressing the A button while the **EC-M** is highlighted will turn on/off your counter measures and bring you back to the flying mode.

When the enemy is at close range you should select your **M-61** machine gun. You start with 675 available rounds. The CANNON OVERHEAT INDICATOR will light green, indicating that your guns are operational. When firing your guns, the CANNON OVERHEAT INDICATOR will flash red to warn you that your guns are in danger of overheating. When it turns bright red, your guns are overheated and will automatically be shut down for cooling. When the lamp returns to green, you can fire your guns again.

Pressing the joystick button while **AIM-** is highlighted allows you to select a missile type. The ARMAMENTS screen will now appear.

You have a choice of three types of Air Interception Missiles:

AIM 7: Sparrow, infrared missiles (most effective when the BOGEY is visible on your viewing screen).

AIM 9: Sidewinders, heat-seeking missiles (most effective when you are on your opponent's tail.)

AIM 54: long range missiles (the best choice for a novice pilot).

You have 15 missiles available of each type. Move the D-Pad to highlight the missile type you want and press the A button to arm your aircraft. At this point you'll return to the flying mode. By pressing the A button, you fire missiles or machine guns. When the BOGEY is within machine gun range (approx. 500 feet) the HUD will flash red. You must continually fire the guns for about three seconds to destroy the enemy aircraft.

Each time you fire a missile you must wait until the MISSILE READY INDICATOR lights to fire another missile.

If you run out of a missile type, the computer will automatically select the most effective missile type from your remaining armaments. You may also select another type of missile by bringing up the THREAT screen and pressing the SELECT button.

When using missiles, use the HEADS UP DISPLAY to lock your missile onto your target by moving the BOGEY into the center of the HUD. The HUD flashes red when your computer has locked on to the target. Firing at this time guarantees a hit.

If you run out of machine gun ammunition, the computer will automatically not allow you to turn on your machine guns and arms any remaining missiles. If you use all of your missiles, the computer will not allow you to select a missile type.

DEFENSIVE WEAPONS AND MANEUVERS

When a BOGEY is on your tail and fires a missile at you, the CAUTION WARNING INDICATOR (see cockpit diagram) will flash. As the enemy missile approaches the C/W INDICATOR will flash faster. If your electronic counter measures (**EC-M**) are on, the EC-M screen will automatically appear on your Horizontal Situation Display. The on-coming missile will appear as a flashing blip approaching your aircraft.

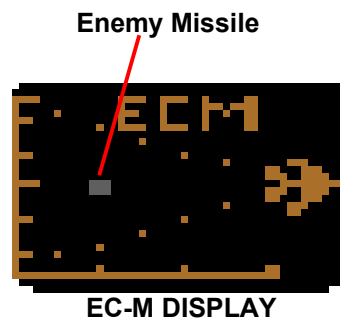

In order to avoid the missile you will want to take evasive action by banking, climbing or diving. When the C/W INDICATOR has stopped flashing you have successfully avoided the missile.

LANDING

When you are running low on fuel or have used up most of your available armaments, you'll be called back to the aircraft carrier. The LANDING screen will appear on your MAIN COMPUTER DISPLAY showing your **SPEED**, **ALT**itude, range (**RNG**, your distance from the carrier), and your **Angle Of Attack**, along with an audible return signal.

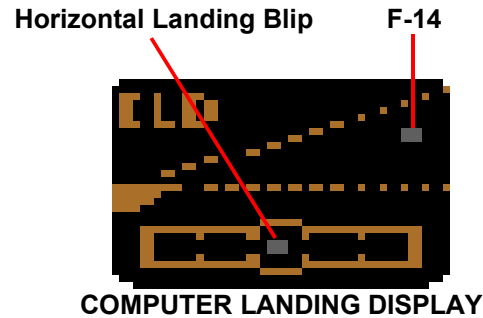

Hold the L button and press UP on the D-Pad until the STATS 2 screen appears on your main computer display. To land you must bring your compass heading (**C-HDG**) to approximately 30° (30° to 40°) by banking to the right or the left and lower the altitude of your F-14 to below 2,000 feet. Also, lower your engine thrust to 30% in order to reduce aircraft speed for landing.

After your F-14 has dropped below 2,000 feet at a compass heading of approximately 30° you will enter the landing corridor and, in a few seconds, you'll see the carrier appear as a dot in the distance. The COMPUTER LANDING DISPLAY (**CLD**) screen will appear on your HORIZONTAL SITUATION DISPLAY.

The CLD has two graphs showing your position relative to the aircraft carrier. The top graph displays your altitude and range. Maintain the blip between the upper and lower limits of your vertical glide path by adjusting your altitude. Try to keep the aircraft's altitude between 60 and 80 feet. The graph below allows you to center your aircraft horizontally. As you approach the carrier you may encounter cross winds. Simply bank the aircraft to the right or left to center yourself for a successful landing on the flight deck. You must keep the blip in the center of the graph to ensure a safe landing. When your aircraft is over the flight deck you will hear a warning sound. Press UP on the D-Pad to drop the aircraft onto the deck.

When approaching the carrier and your landing gear or arresting hook is not in the correct "down" position, a klaxon horn will sound. Hold the L button and press LEFT on the D-Pad to lower your Landing Gear, and hold the L button and press RIGHT on the D-Pad to lower the Arresting Hook so the aircraft can catch the carrier cable.

If you have landed successfully, you'll be back on the deck of the aircraft carrier. Reduce your thrust to 0%. The RATING SCREEN will appear on your MAIN COMPUTER DISPLAY, showing the number of KILLS, missiles FIRED, and providing an overall RANK for your mission. Press the A button and you'll be on the deck ready for another take-off.

If you forget to put your landing gear or your arresting hook down, come in too low, too high, or too far right or left on the carrier deck, you will crash and receive the final rating. Hit the SELECT button to start a new game.

RATINGS:

- 0 – CIVILIAN
- 1 – SWABO
- 2 – RECRUIT
- 3 – SEAMAN
- 4 – LIEUTENANT J.G.
- 5 – LIEUTENANT
- 6 – LIEUTENANT COMMANDER
- 7 – COMMANDER
- 8 – CAPTAIN
- 9 – TOP GUN GRADUATE

TIPS FROM THE DESIGNER

It is a good idea to turn on your Electronic Counter Measures as soon as you're launched from the flight deck.

To avoid an enemy missile, adopt an eccentric flight path. Dive, climb and bank quickly. If you haven't turned on your Electronic Counter Measures before an enemy attack, you still have time to do so once a missile has been fired at you.

During combat, try to keep the BOGEY on your viewscreen at all times and stay on his tail. This will keep him from getting behind you.

While approaching the aircraft carrier for a landing, you'll see the carrier landing lights before you. Keep the center line of lights straight to ensure that you're centered on the flight deck.

Approach the carrier at a speed well below 1.0 Mach to insure a safe landing.

To reduce the amount of fuel used during flight, throttle back your engine thrust to below 100%.

The altitude of the flight deck at landing is approximately 60 feet.

When flying at night, you must depend more on your instrumentation, especially when engaged in combat.

GLOSSARY

ACM –	AIR COMBAT MANEUVERING
AIM –	AIR INTERCEPTION MISSILE
AOA –	ANGLE OF ATTACK
BOGEY –	UNDEFINED AIRCRAFT
CANOPY –	GLASS BUBBLE OVER THE COCKPIT
C/W –	CAUTION / WARNING
ECM –	ELECTRONIC COUNTER MEASURES
G –	UNIT OF ACCELERATION
HSD –	HORIZONTAL SITUATION DISPLAY
HUD –	HEADS UP DISPLAY
CLD –	COMPUTER LANDING DISPLAY

ACTIVISION
PROTOTYPE

UNKNOWN ACTIVISION® PROTOTYPE #1

1 player

Found in a salvage yard in 1998, the identity of this mysterious Activision prototype still remains a mystery. The game binary itself was sent to all of the original alumni for possible identification, only to still turn up nameless. The only alumni able to comment on the title at all was Alan Miller. His thoughts were that it may have been an early Activision foray into 3-D gaming on the Atari 2600 platform. Still he too was unsure of it's true nature.

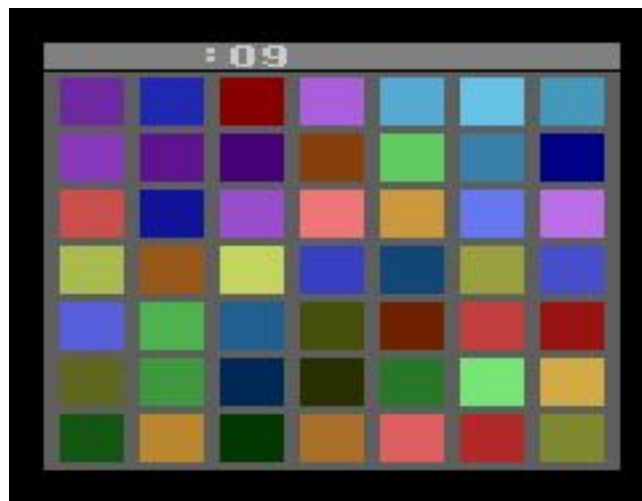

GAMEPLAY

Unknown Activision Prototype #1 play like a cross between a 3-D puzzle cube and the old "sliding tiles" puzzle game. The goal of the game seems to be that you, the player, need to line up all the colors in each row, from light to dark. If you've done it correctly, the board should look like the initial startup screen with the colors descending from red to purple.

Lining up all the colors is easier said than done due to the unique way the squares move across the board. When you move your square up or down a row or column, the last square in that row will move behind your square's new position.

Mastering how the squares move is essential to solving the puzzle. If you forget what the original order of the squares was, pressing the A button will cause all the squares in the correct positions to turn black. While this is helpful for positioning the shades of color in each row, it won't help you remember what color is supposed to go in each row.

CONTROLS

The difficulty switches are not used for this game. In other word, holding the L button and pressing LEFT or RIGHT produces no effect.

Hold the L button and press UP on the D-Pad to select a game variation:

Game Variation #1: The board is always randomized at the start of this game.

Game Variation #2: The board pattern is fixed in this game.

Game Variation #3: This game is (still) a mystery. Unlike the other two games, the board starts out already solved. Of interesting note, is that this game is not timed like the others. Instead, it appears as though you are able to score points in some manner. This game variation may be unfinished.

Game Variation #4: This almost seems to be "Demonstration Mode". In this variation, the board starts out empty and is filled in by the sliding squares. It does not appear that the player can interact with this game in any way.

While Activision® Prototype #1 looks above average for a 2600 game at that time, the gameplay just doesn't seem up to Activision standards. The game seems a bit slow, overly difficult, and in the end "Not terribly enticing". Perhaps this is the reason this game never saw the light of day. Still, it's a piece of Activision's 2600 history and we're glad that we could present this one teeny tiny slice of it to you.

ACTIVISION
PROTOTYPE

UNKNOWN ACTIVISION® PROTOTYPE #2

1 player

Unknown Activision® Prototype #2 was also found in a salvage yard in 1998. Since the label that once existed for this game has long since fallen off the cartridge casing, we really have no idea as to the identity of this game. The game binary itself was sent to all of the original alumni for possible identification, only to still turn up nameless. However, this game appears to be much more playable than Unknown Activision® Prototype #1.



In Unknown Activision® Prototype #2, you control a sort-of Space Flea who must use the blocks at the bottom of the screen to build an escape ladder and "flee" the scenario he's in. As these blocks come rolling down the conveyor belt, you must jump up and bump the blocks as so they land on top of each other, thus creating a sort of escape ladder or path. Blocks that are bumped and/or are knocked near the edge of the screen don't accrue any score at all. "Odd, to say the very least."

Character movement in this prototype is a bit unusual as well. It seems the longer you hold the D-Pad in a certain direction, the faster your flea will run. Although this is a nice touch, it's a bit odd for a 2600 game and may take some getting used to.

Now, once you've constructed your Escape Ladder or Path, you must carefully jump on the conveyor belt avoiding all forthcoming blocks and then make your way to the Ladder itself, all the while avoiding the moving blocks. Touching one of the blocks will crush your flea and you'll end up having to start all over again.

Starting on the second level, you will undoubtedly notice that some blocks will flash yellow or blue. These colored blocks are actually part of an elaborate timing/bonus system. The yellow block (which we'll call the "Bump block") moves up the tower at a rate of one block a second, while the blue block (which we'll call the Bonus block) moves up the tower one block every time the yellow block reaches the top of the screen. If your flea happens to be on the tower when the yellow block touches him, you'll be knocked down one level (now slowing your decent up the ladder). However, if your character touches the blue 'Bonus' block, you'll gain bonus points as long as he remains on the block. Greed can be a dangerous thing though, as the tower will eventually collapse after a certain amount of time (determined by the difficulty level). When the warning alarm sounds, you have approximately 10 seconds to high-tail it up the ladder or you'll be crushed by its falling debris.

Starting on the third level, strange alien creatures will begin to emerge from around the screen. You can destroy them by hitting them with a block. Smashing any of these aliens is worth 180 points, while simply bumping a block will only net you 5 points.

If you let the Octopus alien reach the bottom of the screen, he'll start breeding other alien enemies that will eventually clog your playing field, making game play even tougher. Since you can knock the extra aliens out of the way using your blocks, he's not that much of a problem. If you're really good, you can try using this method to your advantage and use the blocks to fence the alien in.

Starting on the fourth level, a squat looking alien with two legs will rapidly move down the screen and try to catch your flea at the bottom of the screen. When this happens, you'll need to jump on the conveyor belt temporarily to escape until he disappears. Unfortunately, this Alien Boss is immune to your blocks so the trick is to avoid him at all costs. Do that, and you'll be OK!

Unlike most Activision Atari® 2600 titles, this prototype has no game variations what-so-ever. Again though... "This is a prototype".

Hold the L button and press LEFT on the D-Pad to set the difficulty level (**A** is hard, **B** is easy).

Hold the L button and press RIGHT on the D-Pad to control how your character climbs the tower: In the **A** position, you cannot touch the tower, as doing so will result in a block smashing your character. In the **B** position, your character can climb the tower normally.

Although this prototype appears to be nearly complete, there are still quite a few bugs to be found in the game.

The graphics and sounds for this title look to be top notch. It's obvious that a lot of work went into this game. Everything from the smooth animation of your character to the cute "Can-Can" sequence at the start of the game really screams quality. "So why was this title never released?" Unfortunately, no one but the original programmer knows the answer to that. The game EPROM, which this cartridge came to us on, was labeled MM NTSC D#3, which really doesn't match up with any of Activision's known works in progress.

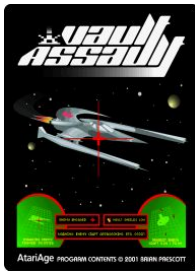

VAULT ASSAULT

Homebrew game by Brian Prescott

1 player

© 2001 Brian Prescott

OBJECT OF THE GAME

The object of Vault Assault is to keep your vault from being destroyed for as long as possible. Fighter ships appearing from four different directions (the top of the screen, left side, right side and bottom) will appear. Once a fighter appears, it will delay for a short time before firing a bomb at the vault.

Your defenses consist of a laser cannon that can be positioned in these same four directions. You must destroy any fighter or bomb that appears. As the game goes on, the fighters appear for a shorter period of time and fire their bombs toward the vault faster.

Occasionally, a miniature vault will appear at either the top or bottom positions on the screen. If you do not fire at and destroy the miniature vault, when it disappears, you will receive a bonus vault.

PLAYING THE GAME

Please refer to the official manual of *Activision® Anthology* for Game Boy® Advance to review how to setup and select this game.

Use the D-Pad to move the cannon to one of the four firing positions. When the A button is pressed, a laser blast will be fired in the current direction of the cannon. There is a slight delay after the cannon is fired before it can be moved and fired again.

For each fighter (or miniature vault) that you destroy, you will receive 100 points, and for each bomb that you destroy, you will receive 10 points. The game starts at level 1, and once you destroy a certain number of fighters and bombs, you will automatically advance to the next level, up to a maximum of level 9. A bonus vault is awarded for every 10,000 points that you score, up to a maximum of 9 vaults in reserve.

CONSOLE CONTROLS

To start (or reset) the game, press the SELECT button. The level number (from 1 to 9) and number of reserve vaults remaining (maximum of 9) appear at the bottom of the screen.

The other switches are not used (or in other words, holding the L button and pressing any direction on the D-Pad produces no effect).

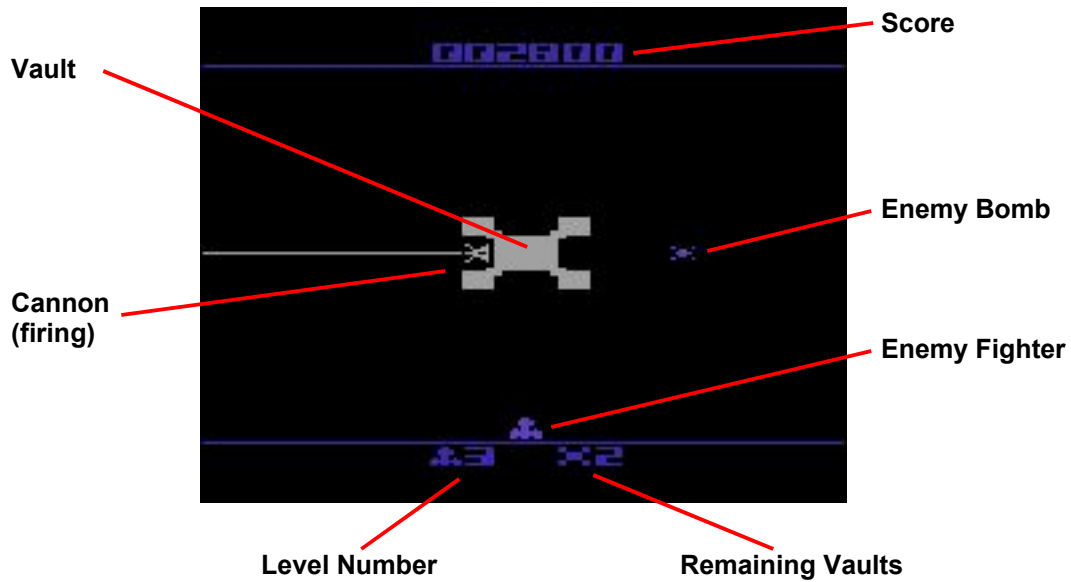

TIPS FROM BRIAN PRESCOTT, DESIGNER OF VAULT ASSAULT

The fighters on the left and right side of the vault are farther away from the vault, so their bombs take slightly longer to reach the vault than those fired from the top or bottom. However, once you reach level 9, this difference is negligible, so the best bet is to pick off the fighters in the order that they appear.

If you want a slightly different challenge, follow these steps:

1. Select another game with Link Cable support (such as "Kaboom!") from *Activision® Anthology's* main game menu. Do not boot up the game immediately. Instead, get to the screen with the message "To add a second player, please connect a Game Boy® Advance Game Link cable... etc." and let it wait there.
2. Connect another Game Boy® Advance unit with the Link Cable, as described in the official instruction manual.
3. Turn the other Game Boy® Advance on, then boot up the selected game on your GBA. The message "Player 2 Ready" should now appear on the screen of the other Game Boy® Advance.
4. Press the START button on your GBA, press the A button to exit the game, and go back to *Activision® Anthology's* main game menu.
5. Select "Vault Assault" from the menu, and run the game normally. Now press the A button on the other Game Boy® Advance, and get ready!

Thanks for your interest and good luck.



As the name implies the Venetian Blinds demo isn't a game, but a demo that simulates a pair of Venetian blinds! The D-Pad can be used to raise and lower the blinds by pressing UP or DOWN. When the blinds are raised a nicely done sunset is visible out the window.

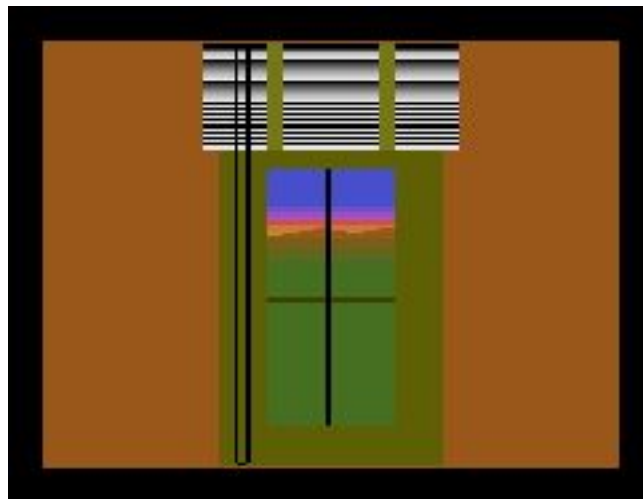

Explanation by David Crane

"The Venetian Blind cart is a working 2600 demo that shows a landscape at sunset outside a window, covered by a fully operational Venetian blind – one that moves up and down under joystick control. Here is how it came about:

"When Atari sued Activision they laid claim to certain 'proprietary' techniques. One technique for which they claimed ownership was first used by Bob Whitehead in the display code of the Atari Chess cartridge. This method moved the display objects back and forth every scan line to allow the game to display more objects. On the chess pieces, for example, Bob showed the odd pixel row of the odd numbered columns of pieces and the even pixel row of the even numbered columns. We called this the Venetian Blind technique since it made the pieces look like they were being viewed through a venetian blind.

"One day in the lab at Activision while the lawsuit was in full swing, Bob and I collaborated on a practical joke. We made a display showing an architecturally accurate window with a view of a grassy hill at sunset. We covered it with a venetian blind effect that animated up and down (complete with the stacking up of the slats as they were gathered up by the blind mechanism). We took it to CES and showed it to a few people who were privy to the lawsuit, asking "Is this what Atari means by the Venetian Blind Technique?"

"The joke was on us in one respect, when we realized that we had made public our latest innovation (the background sunset) when we showed it to our competitors. (Several games in the lab were using this new idea, but they had not yet been published.) As it turned out, nobody picked up on our slip and nobody beat us to market with the sunset."

ADDITIONAL NOTES

In the end Atari ended up losing the lawsuit and Activision went on to become the most successful of the 2600 third party companies. Although Activision never made a game out of this demo it didn't go completely to waste. The sunset was later used in the background of Barnstorming.



HOW TO PLAY

Please refer to the official manual of *Activision® Anthology* for Game Boy® Advance to review how to setup and select this game.

Note: While this manual does describe how to play Euchre, it is assumed that you are familiar with basic card game concepts, such as a hand, trick, and trump.

Euchre (pronounced "yoo-ker") is a card game for four players divided into two teams. With this cartridge, the computer acts as your partner and two opponents. The objective in each hand is to win at least three of the five tricks in the hand, earning your team points. The team that scores ten or more points wins the game.

At the start of the game, the computer randomly selects a dealer. That player deals five cards to each player and turns over the top of the remaining four cards. The suit of this turned-up card is the proposed trump suit for the hand.

Each player examines his or her hand to determine if their team is likely to take at least three tricks, taking into account the suit designated as trump. The player then chooses to pass to the next player, order up the trump card, or go alone. The dealer picks up the turned-up card and exchanges it for one from his hand, keeping the discarded card face down. The suit of the turned-up card becomes trump. If the choice was to go alone, that player's partner does not play in this hand.

If the three non-dealers and the dealer pass, the dealer turns over the proposed trump card. Each player then may choose to pass, call a trump suit, or go alone and call a trump suit. The trump suit named may not be the suit that was turned down. If everyone passes a second time, the hand is thrown in and the deal goes to the player at the dealer's left.

Whichever player chose to order up trump, call trump, or go alone is called the **maker**.

The player to the left of the dealer leads to the first trick. Play continues with each successive player to the left. Each player must follow suit when possible; if it is not possible, any card of any suit may be played. After all players have laid down a card, the trick is complete. The trick is won by the player who played the highest card of the led suit if no trump was played or the highest trump card if trump was used. The player who won the trick leads to the next trick.

When all five tricks have been played, the hand is over. If the maker's team won at least three tricks, that team scores at least one point; otherwise, that team is **euchred** and their opponents score two points. For winning five tricks (a **march**), the maker's team scores two points if both players were in the hand or four points if the maker went alone.

If one team has ten or more points, that team wins. Otherwise, the player to the dealer's left becomes the new dealer, and play continues.

THE EUCHRE DECK

A Euchre deck has only 24 cards from a standard pack of 52: the nine, ten, jack, queen, king, and ace of each suit.

The rank of each card depends on the trump suit. In the trump suit, the highest card is the jack, called the **right bower**. ("Bower" rhymes with "hour.") The second-highest card, the **left bower**, is the jack of the other suit of the same color. For example, if spades is trump, then the jack of spades is the right bower and the jack of clubs is the left bower. The remaining cards have their standard order, from ace down to nine.

Note that for purposes of following suit, the left bower is considered to be of the same suit as trump; in the previous example, the jack of clubs is treated as a spade during play.

In the other two non-trump suits, the ace is the highest rank, followed by the king, and so on, down to the nine.

CONSOLE CONTROLS

Game Select switch (hold L button and press UP on D-Pad):

Not used.

SELECT button:

Use this switch to start a new game at any time.

Left Difficulty switch (hold L button and press LEFT on D-Pad):

In the **A** position, the dealer must name a trump suit if the initial trump suit is turned down and all the other players have passed twice. This is the commonly used "stick-the-dealer" variation. In the **B** position, the dealer is free to pass a second time, in which case the hand is thrown in.

Right Difficulty switch (hold L button and press RIGHT on D-Pad):

Not used.

Color/Black & White switch (hold L button and press DOWN on D-Pad):

Not used.

THE DISPLAY

The large numbers at the top of the screen are the scores of the two teams. Your team's score is on the left; the opposing team's score is on the right.



During a hand, the tricks taken by each team is shown directly beneath their scores. One block is displayed per trick.

The region beneath the tricks is used for displaying either information or instructions. The symbols that can appear here are listed below:

- **A suit** – the current trump suit, which is shown beneath the score and tricks of the maker's team
- **The letter D** – "deal", instructing you to press the A button to start the next deal
- **The letter S** – "swap", instructing you to swap a card in your hand for the turned-up card
- **An arrow and letter** – the arrow points to the player making a decision and the letter indicates the decision itself: P for "pass," U for "order Up" or "call trUmp," or A for "go Alone".

The large white area is the card table. Cards are played here during a trick. The top portion is for your partner's card, the left and right sides are for your opponents' cards, and the bottom portion is where your play is shown. Consider the four sides of the table as a compass, with north at the top; this puts you at the south side, with your partner at north, and the opposing team at west and east.

After all the cards in a trick are played, they will automatically vanish and a trick indicator will be added to whichever team won the trick. Note that when one of the players is a lone maker, only three cards will be displayed in a completed trick, since the maker's partner is not in play.

The five white boxes below the card table are the cards in your hand. A blank box indicates a card that has already been played.

The bottom region is used when you are deciding whether to pass or accept trump and choosing a suit to name as trump. When it is your turn, the letters "PUA" are shown, with the same meanings as given above. If you select U or A and the turned-up suit was turned down, all four suit symbols are shown so you can name a trump suit.

USING THE CONTROLLER

Use the D-Pad to select a card to play or swap for the turned-up card, choose whether to pass or become the maker, and to pick a suit to name a trump. Press the A button to play the card or confirm your decision.

When it is your turn to play or swap a card, a cursor in the shape of a blue bar appears among the cards of your hand. Press UP or DOWN on the D-Pad to move the cursor to the card of your choice. Press the A button to play or swap the selected card. If you make an illegal selection, such as not following suit when you are able, you will hear a warning sound and must make another selection.



When you are deciding whether to pass or become maker, the letters "PUA" are shown in the bottom region of the screen. A cursor in the shape of a dot is below one of these letters. Press LEFT or RIGHT on the D-Pad to move the cursor underneath the letter corresponding to your decision. If you make an illegal selection, choosing to pass a second time when you are the dealer and the "stick-the-dealer" rule is active (see **Console Controls**), you will hear a warning sound and must make another selection.



When you are picking a suit to name as trump, the four suit symbols are shown in the bottom region of the screen. A cursor in the shape of a dot is below one of these symbols. Press LEFT or RIGHT on the D-Pad to move the cursor underneath the suit which you want to name as trump. If you choose the same suit as the turned-down card, you will hear a warning sound and must make another selection.



Press the A button to start a new deal after a hand is finished and points have been awarded. The screen will go blank for a fraction of a second while the cards are shuffled and dealt.

If a game has ended, you can either press the SELECT button or the A button to start a new game.

SCORING

When a hand is over, points are awarded to one of the teams depending on which team won the majority of the tricks, how many tricks were won, and if the maker went alone.

- Maker's team took less than three tricks: Opponents get two points
- Maker's team took three or four tricks: Maker's team gets one point
- Maker's team took all five tricks (march): Maker's team gets two points
- Maker went alone and took five tricks: Maker's team gets four points

The team that reaches ten or more points wins the game.

STRATEGY

Here are a few tips to help you get started playing Euchre:

- Do not become maker unless you are reasonably certain you can take three tricks yourself. A common Euchre adage is "count on your partner for one trick." This is often not the case, as the strength your partner may have is likely from a different trump suit, or your partner may have passed because he or she has a weak hand. However, taking a risk is occasionally worthwhile.
- In most situations, it is not a good idea to play trump on a trick your partner is winning with an ace of a non-trump suit. Since the ace is the highest card in a non-trump suit, only a trump can beat it, so your partner is likely to win the trick. There are exceptions to this, notably when the ace is of a suit that was led before, or several cards of that suit are in your hand or have been used in tricks. In this case, playing trump is a good idea, since with so many cards of the led suit already gone, your opponents will probably be able to trump as well.
- If you are going to play trump on a trick, and you are not the last person to play in that trick, be careful about playing too low a trump. The next player may be able to beat it. This does not necessarily mean you should use a bower immediately; just be careful about using a nine or ten unless the led suit was the first appearance of that suit in the hand.
- Draining the other players of trump by leading the highest trump left in the hand is useful, but only if you have a couple of additional trump cards or some off-trump aces to follow up with. Otherwise, you may find that your opponents can take your remaining cards, and your partner may also be out of trump.
- You can probably be a lone maker if you have the right bower, either the left bower or the ace, and a mix of low trump and high non-trump, preferably aces. It is easiest if you lead to the first trick, as you this will give you an opportunity to immediately drain your opponents' trump.

No hint or tip applies to all scenarios. As you play more often, you will learn to recognize situations in which you should pass or become maker, trump or play off, and whether to go alone or keep your partner. Do not be afraid to take measured risks as it is the only way you will learn what choices can be successful. Also, be patient; Euchre is a game of both skill and luck, and there are times in which your hand has no cards that can affect play. Just wait for the next hand.

Books that provide the rules of Euchre usually have a section on strategy. For a more thorough examination of strategy, please consult a book at your local book store or library, or search for "Euchre strategy" with your favorite Internet search engine.

Most importantly, have fun!

EUCHRE WITH HUMANS

When playing Euchre with real cards and real people, there are some conventions to consider and variations to explore.

The deal is usually completed in two rounds, traditionally by giving a player two cards in the first round and three cards in the second, or three in the first and two in the second, and not giving two adjacent players the same number of cards in the same round.

Partners should sit across from each other, or if not possible, should at least be separated by a player from the opposing team.

Scoring is normally done by using cards from a standard deck that are not part of a Euchre deck. Two fives are given to each team. One five is placed face down on top of another, which is face up. As points are awarded, a corresponding number of pips are revealed on the bottom card. When a team reaches five points, the top card is turned over. This means that at all times, the number of pips showing is the score for the team.

Besides the "stick-the-dealer" variation provided in the game program, other variants allow a player to have the hand thrown in when his or her hand is weak: a "farmer's hand" (all nines and tens) or "ace-no-face" (all nines and tens except for one ace). There are also variations for three players, in which the maker plays against the other two players, who are temporarily partners, and for six players, in which the maker's team plays against the other two teams. In the six-player version, sevens and eights are added to the deck so that every player can still be dealt five cards.

CREDITS AND ACKNOWLEDGEMENTS

The Euchre game software and this instruction manual were written by Erik Eid.

The label artwork and manual cover page were designed by David Exton.

It would not have been possible to create Euchre without the help of the members of the Stella mailing list. Stella is a community of Atari 2600 programmers and enthusiasts who create new games and provide suggestions on both gameplay and development.

Special thanks go to Stella members Andrew Davie and Thomas Jentzsch, who gave critical advice on optimization on several occasions. Without their help, Euchre would not fit into a standard 4 KB cartridge and definitely would not be finished at this time.

Readers of the AtariAge 2600 forum also offered advice and playtesting services, both of which are greatly appreciated. AtariAge is an excellent resource for information and discussion about Atari game systems and computers.

Lastly, this game is dedicated to two groups of people: first, to all those who supported my dream, whatever it was at the time, and second, to all those who are dreamers. May you find the way to yours.

LEGAL INFORMATION

The Video Euchre game software and this manual are copyright © 2002 by Erik Eid, the author of the game. All rights are reserved by the author.

Permission is granted to distribute the ROM image for the game provided this manual always accompanies the ROM image. The author respectfully requests that anyone wishing to post the game on a web site, FTP archive, or include it in a freeware or shareware compilation contact the author in advance.

The author makes no guarantee as to the accuracy of either the electronic or printed version of the manual and disclaims liability for changes, errors, or omissions.

The author is not responsible or liable for any damages that may result from the use of the Video Euchre software in any of its possible forms, including but not limited to ROM image, audio file, and cartridge. No warranty is implied or given.

The end user may freely use the Video Euchre software as a ROM image through Atari 2600 emulator software, an audio file through a Supercharger or Cuttle Cart, or a cartridge manufactured by an authorized person. No one except persons authorized by the author may manufacture or distribute the Video Euchre software in cartridge form or any media that may store an audio file usable with a Supercharger, Cuttle Cart, or similar device, such as but not limited to a record, cassette, compact disc, mini disc, or digital versatile disc, or as part of a stand-alone gaming unit with its own display or one that uses a television or monitor for display purposes.

APPENDIX A

COMPLEMENTARY DOCUMENTS

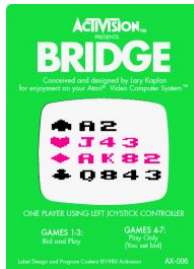

BASIC RULES OF BRIDGE

© 1995, 1997, 2003 John McLeod

Card Games web site – <http://pagat.com>

As the official instruction manual indicates (see page 29), Bridge by ACTIVISION® is meant to be played by people who already know the rules of the game of Bridge. If you are unfamiliar with this card game, but would like to learn it in order to play it on your Game Boy® Advance with *Activision® Anthology*, the rules are presented here, courtesy of John McLeod, maintainer of the **Card Games web site (found at <http://www.pagat.com>)**.

However, if you cannot make heads or tails of the rules below, the best thing to do is to find a Bridge player who can teach you the basics and give you a few lessons. You can also look around the internet for online Bridge web sites.

TYPES OF BRIDGE

Contract Bridge was invented in the 1920's and in the following decades it was popularised especially in the USA by Ely Culbertson. Bridge currently occupies a position of great prestige, and is more comprehensively organised than any other card game. There are clubs, tournaments and championships throughout the world.

Rubber Bridge is the basic form of Contract Bridge, played by four players. Informal social bridge games are often played this way, and rubber bridge is also played in clubs for money.

Duplicate Bridge is the game normally played in clubs, tournaments and matches. The game is basically the same but the luck element is reduced by having the same deals replayed by different sets of players. At least eight players are required for this. There are some significant differences in the scoring.

Chicago Bridge is played by four people (like rubber bridge), but a game is complete in four deals.

Contract Bridge developed from Auction Bridge, which is different mainly in the scoring. In Auction Bridge, overtricks count towards making game, so it is only necessary to bid high enough to win the contract – there is no incentive to bid all the tricks you can make.

Before Auction Bridge there was Bridge-Whist or Straight Bridge (at the time this game was just called Bridge). The earliest published rules of Bridge appeared in 1886 under the name Biritch or Russian Whist. In Bridge-Whist there is no bidding at all – the dealer either names a trump suit or passes, in which case the dealer's partner must choose trumps. In either case the dealer's partner is dummy. Either opponent may double before the lead to the first trick, and if doubled, the dealer's side may redouble. In the earliest form of the game, after any redouble, the other side can redouble again, and this can continue indefinitely.

*Only the rules of Rubber Bridge are covered by this section of this document. Visit John McLeod's **Card Games web site**, at <http://www.pagat.com>, for more information about the other variations of Bridge.*

RUBBER BRIDGE

Players and Cards

There are four players in two fixed partnerships. Partners sit facing each other. It is traditional to refer to the players according to their position at the table as North, East, South and West, so North and South are partners playing against East and West. The game is played clockwise.

A standard 52 card pack is used. The cards in each suit rank from highest to lowest:
A K Q J 10 9 8 7 6 5 4 3 2.

Deal

The cards are shuffled by the player to dealer's left and cut by the player to dealer's right. The dealer deals out all the cards one at a time so that each player has 13. Turn to deal rotates clockwise.

It is traditional to use two packs of cards. During each deal, the dealer's partner shuffles the other pack and places it to the right. The dealer for the next hand then simply needs to pick up the cards from the left and pass them across to the right to be cut. Provided all the players understand and operate it, this procedure saves time and helps to remember whose turn it is to deal, as the spare pack of cards is always to the left of the next dealer.

Bidding

There is next an auction to decide who will be the declarer. A bid specifies a number of tricks and a trump suit (or that there will be no trumps). The side which bids highest will try to win at least that number of tricks bid, with the specified suit as trumps.

When bidding, the number which is said actually represents the number of tricks **in excess of six** which the partnership undertakes to win. For example a bid of "two hearts" represents a contract to win at least 8 tricks ($8 = 6 + 2$) with hearts as trumps.

For the purpose of bidding the possible trump suits rank as follows: no trumps (highest), spades, hearts, diamonds, clubs (lowest). A bid of a larger number of tricks always beats a bid of a smaller number, and if the number of tricks bid are equal, the higher suit beats the lower. The lowest bid allowed is "one club" (to win at least 7 tricks with clubs as trumps), and the highest is "seven no trumps" (to win all 13 tricks without trumps). *NB. In North America, the term for contracts played without a trump suit is "notrump" or "no trump" (without an 's').*

It is also possible, during the auction, to "double" a bid by the other side or to "redouble" the opponents' double. Doubling and redoubling essentially increase the score for the bid contract if won and the penalties if lost. If someone then bids higher, any previous doubles and redoubles are cancelled.

Note that doubling does not affect the ranking of a bid – for example a bid of two spades is always higher than two hearts, even if the two hearts bid has been doubled or redoubled.

The dealer begins the auction the turn to speak passes clockwise. At each turn a player may either:

- make a bid, which must be higher than the previous bid if any;
- say "double", if the previous bid was by an opponent, and has not already been doubled;
- say "redouble", if the previous bid was by one's own side and has been doubled by an opponent, but not yet redoubled;
- pass, by saying "no bid" or "pass". This indicates that the player does not wish to bid, double or redouble on that round, but a player who has passed is still allowed to bid, double or redouble at a later turn. *NB. Either "no bid" or "pass" is permissible, but you should stick to one term or the other. "No bid" is usual in Britain; "pass" is usual in the USA.*

If all four players pass on their first turn to speak the hand is said to be **passed out**. The cards are thrown in and the next dealer deals.

If anyone bids, then the auction continues until there are three passes in succession, and then stops. After three consecutive passes, the last bid becomes the contract. The team who made the final bid will now try to make the contract. The first player of this team who mentioned the denomination (suit or no trumps) of the contract becomes the **declarer**. The declarer's partner is known as the **dummy**.

Example of an auction (North dealt):

North	East	South	West
pass	1 heart	double	3 hearts
3 spades	pass	4 spades	pass
pass	pass		

North–South will try to win at least 10 tricks with spades as trumps; North, who mentioned spades first, is the declarer. South's double of one heart was cancelled by West's bid of 3 hearts.

The Play

The player to the left of the declarer leads to the first trick. Immediately after this opening lead, the dummy's cards are exposed. The dummy should arrange them neatly in suits, the cards of each suit arranged in rank order in an overlapping column, pointing towards the declarer, so that all the cards are clearly visible. The trump suit if any should be to dummy's right (declarer's left); in the diagram, spades are trump.

Play proceeds clockwise. Each player must if possible play a card of the suit led. A player with no card of the suit led may play any card. A trick consists of four cards, and is won by the highest trump in it, or if no trumps were played by the highest card of the suit led. The winner of a trick leads to the next.

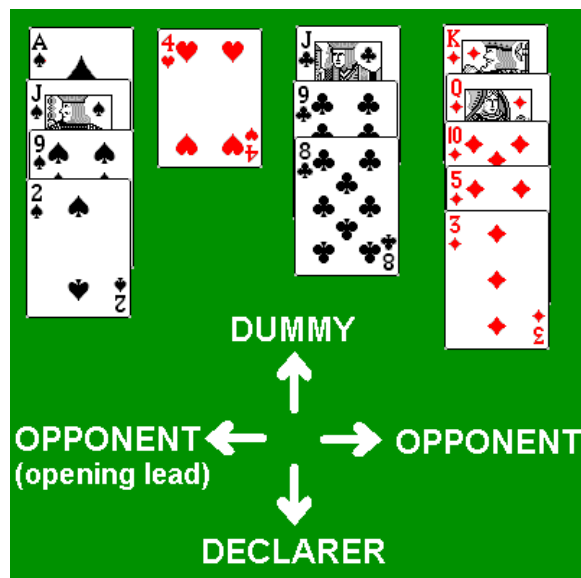

Each trick is gathered together and turned face down when complete, but you may ask to see the cards and ask who played which card until you or your partner has played to the next trick. The

tricks won are to be arranged neatly in front of one member of the winning side, so that they can easily be counted.

Dummy takes no active part in the play of the hand. Whenever it is dummy's turn to play, the declarer must say which of dummy's cards is to be played, and dummy plays the card as instructed (as long as it is legal). Dummy is not permitted to offer any advice or comment on the play. When dummy wins a trick, the declarer specifies which card dummy should lead to the next trick. If when calling for a card the declarer specifies the suit only, dummy is to play the lowest card of that suit.

It is also legal, and not unusual, for the declarer to play dummy's cards by physically taking them from dummy's hand rather than just calling for them. This allows the dummy player to leave the table during the play of the hand.

Scoring

As its name suggests, rubber bridge is played in **rubbers**. A rubber is the best of three **games**. A game is won by the first team to score 100 or more **points** for successful contracts, over several deals if necessary.

A side which has already won one game towards the current rubber is said to be **vulnerable**. A side which has not yet won a game is **not vulnerable**. A side which is vulnerable is subject to higher bonuses and penalties than one that is not.

The score is kept on a piece of paper divided into two columns headed WE and THEY, for the two teams, with a horizontal line part-way down (see example). Scores for successful contracts are entered below the line, and count towards winning a game. Other scores, such as bonuses for tricks made in excess of the contract (overtricks), or penalties for tricks short of the contract (undertricks) are entered above the line, and do not count towards winning the game.

Score for making the contract

For a successful contract, the score below the line for each trick (in excess of 6) bid and made is as follows:

- If trumps are **Clubs** or **Diamonds**, 20 per trick
- If trumps are **Hearts** or **Spades**, 30 per trick
- If there are **No Trumps**, **40** for the first trick, and **30** for each subsequent trick.

If the contract was doubled the above scores are doubled. If it was doubled and redoubled, they are multiplied by 4.

In addition, the declarer's side scores an extra 50 points above the line if they succeed in a doubled contract. This is sometimes known as "50 for the insult". For making a redoubled contract the bonus is 100 above the line.

Because of the difference in score, clubs and diamonds are called the **minor suits** and hearts and spades are the **major suits**.

Slam bonus

A contract to make 12 tricks is known as a **small slam**. A contract to make all 13 tricks is called a **grand slam**. For bidding and making a slam, declarer's side get an extra bonus above the line, depending on their vulnerability, as follows:

Slam bonus	small slam	grand slam
not vulnerable	500	1000
vulnerable	750	1500

Score for overtricks

If the declarer's side wins more tricks than were bid, and were not doubled, then in addition to the score below the line for the contract, they score for the overtricks above the line at the same rate as for bid tricks – i.e. 20 per trick if a minor suit was trumps; 30 per trick in a major suit or no trumps.

If the contract was doubled or redoubled, the bonus for overtricks does not depend on the trump suit, but does depend on whether the declarer's side was vulnerable as follows:

Score per overtrick	doubled	redoubled
not vulnerable	100	200
vulnerable	200	400

Penalty for undertricks

If the declarer's side win fewer tricks than they bid, neither side scores anything below the line, but the declarer's opponents score above the line. This score depends on the declarer's side's vulnerability, and whether the contract was doubled or redoubled, as follows:

Undertrick penalty:	not vulnerable	vulnerable
Not doubled – each undertrick	50	100
Doubled – first undertrick:	100	200
Doubled – 2nd and 3rd undertrick:	200 each	300 each
Doubled – subsequent undertricks:	300 each	300 each

Redoubled undertricks cost twice as much as doubled undertricks.

Honours

The top five trumps (A K Q J 10) are called honours. If one player holds all five of these cards, that player's side scores a bonus of 150 above the line. Four honours in one hand score 100. If there are no trumps, and a player holds four aces, that player's side scores 150 for honours.

Scores for honours are to be claimed at the end of the play (it is assumed that the players will remember what they held).

As there is no skill in scoring for honours, players often agree to play without the honour bonuses.

Game and Rubber

A side that accumulates 100 points or more below the line has won a game. A new line is drawn under the scores. Anything the opponents had below the line does not count towards the next game – they start from zero again.

It is important to notice that, starting from zero and in the absence of doubles, to make a game in one hand you need to succeed in a contract of at least three no trumps, four spades, four hearts, five clubs or five diamonds.

The side which first wins two games wins the rubber. For this they get a bonus of 700 if they won it two games to zero, or 500 if it was two games to one. Both sides' scores are then totalled and if the game is being played for money, the side with the higher score wins an amount proportional to the difference in scores from the side with the lower score. If play ends for any reason with a rubber unfinished, then a side with a game gets a bonus of 300 points, and a side with a **part score** (i.e. a score below the line towards an uncompleted game) gets a bonus of 100.

Example of Rubber Bridge scoring

The scoresheet of a completed rubber might look like this (the letters in brackets refer to the footnotes – they would not appear on the scoresheet):

WE	THEY	
500 (f)		
50 (f)		
100 (f)		
200 (e)	500 (i)	
300 (b)	30 (g)	
60 (a)	30 (c)	
60 (a)	100 (c)	← the line
360 (f)	90 (d)	
60 (h)	40 (g)	
	90 (i)	

- (a) we bid 2 hearts and made 10 tricks – 60 below the line for the contract and 60 above for the overtricks
- (b) they bid 4 spades, we doubled them, and they took only 8 tricks – we score 100 for their first undertrick and 200 for the second
- (c) they bid 3 no trumps and made 10 tricks. This gives them a game (100 below the line). Another line is ruled to indicate this.
- (d) they bid and made 3 spades
- (e) they bid two diamonds and made 6 tricks – they are now vulnerable so we score 100 for each undertrick.
- (f) we bid 6 hearts; they doubled us, but we won all 13 tricks. We score 360 (180 x 2) below the line for our doubled contract, giving us a game; 100 above for our doubled non-vulnerable overtrick; 50 above for making a doubled contract; and 500 bonus for a small slam bid and made.
- (g) they bid one no trump and took 8 tricks; note that their 90 was part of the previous game, so the 40 below does not give them a game.
- (h) we bid 3 clubs and made exactly 9 tricks.
- (i) they bid 3 hearts and took exactly 9 tricks giving their second game and the rubber, for a bonus of 500 (two games to one).

Adding up the scores, we have 1690 and they have 880. Therefore we have won by 810 points (even though they won the rubber).

* Note on changes in scoring

Some details of bridge scoring were changed in 1987 for duplicate bridge and in 1993 for rubber bridge. Before the changes, the penalty for doubled undertricks when not vulnerable was 100 for the first and 200 each for all others (and twice as much for a redoubled contract). Also the bonus for making a redoubled contract was 50, not 100, and the bonus for a part score in an uncompleted rubber was 50, not 100.

Partnership agreement and conventions

As in most card games, partners are forbidden to convey information to each other by talking, gestures, facial expression, etc. However there is considerable scope for partners to exchange information within the rules of the game by their choice of bids or cards played.

The bidding mechanism is such that if a player makes a bid (or double or redouble), it is always possible for the player's partner at their next turn to override that bid with a higher bid. This makes it possible for partners to assign arbitrary meanings to bids. Bids which can be taken at face value – that is they convey a genuine wish to play a contract to take the relevant number of tricks or more with the trump suit stated – are called **natural**. Bids which carry an agreed meaning other than this are called **artificial** or **conventional**.

For example if we are partners, we might agree that a bid of one club by me shows a strong hand, but has nothing to do with wanting clubs as trumps. Provided that we both understand this, you will not leave me to play a contract of one club, but will make some other bid, natural or artificial. Another example: we may decide that to double a low level suit contract in the hope of a penalty is unlikely to be profitable, so we might agree that in certain situations a double simply shows a good hand and asks partner to bid – this is known as a **takeout double**.

The main restriction on agreements between partners about the meaning of bids is that all such agreements must be declared to the opponents. A **bidding system** is a comprehensive set of partnership agreements about the meanings of bids.

Players should declare their system (if any) at the start of a session. Many clubs and tournaments require that this be done by means of a **convention card** which sets out the meanings of bids. In addition, any player may, at their turn to bid or play, ask for and be given an explanation of the opponents' bidding agreements. The explanation should be given by the partner of the player who made the bid in question. For example, if I double a suit contract, either opponent may, at their turn ask my partner what the double means, and my partner must answer according to any agreement we may have about the meaning of the double – for example that it is for takeout or for penalties. If we have no agreement on this, partner should say so – players are not required or permitted to speculate or to guess at the meanings of bids in answer to such a question.

It is sometimes agreed that after the auction, the declarer's left hand opponent, having asked any necessary questions about the declarer's side's bidding agreements, leads the first card face down. The other opponent may then ask questions about the declarer's side's bidding, after which dummy's cards are exposed and play continues as usual. This procedure minimises the risk that by asking a question you may give *unauthorised information* to your partner. Asking at other times during the bidding or play, though legal and sometimes necessary, might be taken to imply that your next bid or play will depend on the answer given.

Similar considerations apply to the play. Partners may agree on the meaning of the choice of card played in certain circumstances. For example we may agree that when leading from a sequence of adjacent high cards such as K–Q–J we always lead the highest. Again, the opponents are entitled to know about such agreements. They should be declared on the convention card, and may be asked about during the play.

In rubber bridge one does not often come across complicated systems and partnership agreements. One is often playing with an unfamiliar partner, or in an informal setting. Complicated agreements are more often encountered in duplicate bridge, where the players are often long standing partners who have devoted considerable effort to agreeing their system.

© John McLeod, 1995, 1997, 2003 (Card Games web site www.pagat.com)

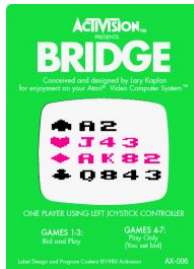

HOW YOUR PARTNER BIDS ON BRIDGE BY ACTIVISION®

Companion booklet

© 1980 Activision Inc.

Your ACTIVISION® computer bridge partner follows a very precise series of steps when reviewing your bids and selecting his response bids. These steps are reprinted here so that you may understand what your partner is thinking and telling you when he bids. **We do not recommend that you try to follow these steps yourself when you are playing with a human partner.** They are limited, by necessity, for computer use only. This booklet is provided for your reference when playing Bridge by ACTIVISION®.

Your computer partner uses an abridged form of the standard American point-count bidding system. He will not make opening bids and will pass any opening bid by you that is not 1 or 2 of a suit or 1, 2, or 3 No-Trump. He uses and recognizes the Stayman and Blackwood conventions.

Your partner counts his points and ranks suits as shown below and follows the steps outlined in each response category **in the order shown** until he finds a suitable bid.

COUNTING POINTS

The computer determines the total point count of his hand by adding high card and distribution points and subtracting discount points, as follows:

- | | |
|----------------------|--|
| High card points: | Each Ace = 4 points,
King = 3 points,
Queen = 2 points, and
Jack = 1 point. |
| Distribution points: | Each void = 3 points,
singleton = 2 points,
doubleton = 1 point. |
| Discount points: | Singleton King, Queen or Jack = -1 point.
Doubleton to Queen or Jack = -1 point.
Tripleton to Jack = -1 point. |

(Void means no cards in a suit; singleton, only one card in a suit; doubleton, two cards in a suit; and tripleton, three cards in a suit.)

SUIT RANKINGS

Rank order (lowest to highest) is Clubs, Diamonds, Hearts, Spades, No-Trumps. The major suits are Spades and Hearts; minors are Diamonds and Clubs. The cheapest suit is the next suit in rank.

RESPONSES TO OPENING BIDS

FIRST RESPONSE TO 1 OF A SUIT OPENING

If computer's total points are:	And...	His bid is:
0–5 points	That's all...	Pass
6–9 points	You bid major; he has more than 4 cards in your suit and more than 1 distribution point.	4 of major
	You bid major; he has more than 2 cards in your suit.	2 of major
	He has suit that can be bid of 1 level and is longer than all other suits.	1 of suit
	He has 2 or more suits that can be bid at 1 level that are equal in length...	
	Length = 4 cards	1 of lowest suit
	Length over 4 cards	1 of highest suit
	You bid minor; he has more than 3 cards in your suit.	2 of minor
10–12 points	His high card points are over 5	1 No-Trump
	None of the above	Pass
	He examines suits other than one you bid and sees...	
	One suit longer than any other suit	Cheapest bid of suit
	Two or more suits same length: Length under 5 cards Length = 5 cards or more	Cheapest bid of cheapest suit Cheapest bid of highest suit
13–15 points	You bid major; he has more than 3 cards in suit	3 of major
	His distribution points = 0–1, high card points over 12	2 No-Trump
	None of the above	Proceed as in 10–12 points
16–18 points	His distribution points = 0–1	3 No-Trump
	Otherwise	Proceed as in 10–12 points
19+ points		Proceed as in 10–12 points, but once he has a suit to bid, he jump shifts (bids one more than the next highest bid in that suit)

FIRST RESPONSE TO 2 OF A SUIT OPENING

If computer's total points are:	And...	His bid is:
0–5 points	He has more than 2 cards in your suit	Game (4 of major or 5 of minor) in suit
	He has anything else	2 No-Trump
6+ points	He has more than 2 cards in your suit	3 of suit
	Otherwise	Proceed as in responses to 1 of a suit, 10–12 points

FIRST RESPONSE TO 1 NO-TRUMP OPENING

If computer's total points are:	And...	His bid is:
0–7 points	He has more than 4 cards in a suit other than Clubs	2 of suit
	Otherwise	Pass
8+ points	He has exactly 4 cards in one or both majors	2 clubs (Stayman)
	He has more than 4 cards in either major	3 of major
8–9 points	–	2 No-Trump
10–14 points	–	3 No-Trump
15–16 points	–	4 No-Trump (Note: not Blackwood)
17–18 points	–	6 No-Trump
19–20 points	–	5 No-Trump
21+ points	–	7 No-Trump

FIRST RESPONSE TO 2 NO-TRUMP OPENING

If computer's total points are:	And...	His bid is:
0–1 points	That's all...	Pass
2+ points	He has exactly 4 or 5 cards in one or both majors	3 clubs (Stayman)
	He has more than 5 cards in a major	4 of major
2–8 points	–	3 No-Trump
9–10 points	–	4 No-Trump (Note: not Blackwood)
11–12 points	–	6 No-Trump
13–14 points	–	5 No-Trump
15+ points	–	7 No-Trump

FIRST RESPONSE TO 3 NO-TRUMP OPENING

If computer's total points are:	And...	His bid is:
0–6 points	That's all...	Pass
6+ points	He has exactly 4 or 5 cards in one or both majors	4 clubs (Stayman)
	He has more than 5 cards in a major	5 of major
6–7 points	–	4 No-Trump (Note: not Blackwood)
8–9 points	–	6 No-Trump
10–11 points	–	5 No-Trump
12+ points	–	7 No-Trump

FURTHER RESPONSES

Once you have opened, your computer partner has responded, and you have bid again, he responds as follows:

- He will pass any bid of 5 clubs or more unless replying to a Blackwood bid.
- If you bid Blackwood (4 No-Trump), he responds as follows:

He has	He bids
0 or 4 Aces	5 Clubs
1 Ace	5 Diamonds
2 Aces	5 Hearts
3 Aces	5 Spades

- If you have bid 4 No-Trump (Blackwood) and then bid 5 No-Trump, he responds as follows:

He has	He bids
0 or 4 Kings	6 Clubs
1 King	6 Diamonds
2 Kings	6 Hearts
3 Kings	6 Spades

- If you have bid 4 No-Trump (Blackwood), then he adds the number of aces you promised by your bid to those in his hand and proceeds as follows:

If a total of	He bids
0, 1 or 2 Aces	Pass if at agreed suit; 5 of agreed suit if he can; or 5 of next suit in rank
3 Aces	6 of agreed suit
4 Aces	5 No-Trump (ask for Kings)

— If **his** last bid was 5 No-Trump (Blackwood), then he adds the number of Kings you promised by your bid to those in his hand and proceeds as follows:

If a total of	He bids
4 Kings	7 of agreed suit
Otherwise	Pass if agreed suit; 6 of agreed suit if he can; or 6 No-Trump

If none of the preceding holds true, he must make two decisions before bidding next:

1. Does the partnership have enough points for game or slam? (See below)
2. Has a suit (or No-Trump) been established?

He estimates your points by reviewing the bidding as follows:

Your opening:	Your second bid:	Your Minimum-Maximum Point Range:
2 of a suit	—	22–25
1 No-Trump	—	16–18
2 No-Trump	—	22–24
3 No-Trump	—	25–27
1 of suit	Cheapest No-Trump	13–15
1 of suit	Jump in No-Trump	19–21
1 of suit	3 of same suit (if not cheapest bid of suit)	16–18
1 of suit	3 of different suit	19–21
1 of suit	Jump shift	19–21
1 of suit	2 of different suit and second suit is higher	19–21
1 of suit	Cheapest bid of same suit	13–15
1 of suit	Single raise of computer suit	13–15
1 of suit	Double raise of computer suit	16–18
1 of suit	Triple raise of computer suit	19–21
1 of suit	No further bids yet	13–18
1 of suit	More than 2 bids	13–15

Once the computer has estimated your minimum and maximum points, he computes the total estimated partnership points by adding your points to his.

The total partnership points needed to bid to game or slams are as follows:

To bid:	You need:
Game	26 points for major suit or No-Trump; 29 points for minor
Small Slam (6)	33 points for any suit or No-Trump
Grand Slam (7)	37 points for any suit or No-Trump

Once total points are estimated, he then estimates the number of cards in your suit, as promised by your bidding:

Your bids:	Length promised:
You opened 2 of major suit	6 cards in your suit
You opened 2 of minor suit	5 cards in your suit
You opened 1 of major suit	5 cards in your suit
You opened 1 of minor suit	4 cards in your suit
You rebid a suit	1 more card for each rebid in your suit
You supported his suit directly	4 cards in his suit
You supported his suit, but not directly	3 cards in his suit

Once points and suit lengths have been estimated, he uses the following rules:

- If total length (yours promised plus his hand's length) is a major totals 8 or more cards, he will bid major (see below).
- If he has not shown you his complete length in one of his majors (whether or not he has previously bid it), he will bid as follows:

0–11 points	Cheapest bid in major
12+ points	Jump in major, or cheapest if above level 4
- If total length in a minor is 9 or more cards, he will bid minor (see below).
- If you bid No-Trump, or if he has stoppers (honor cards that have not been discounted) in all unbid suits, he will bid No-Trump (see below).
- Otherwise, if there are enough points for game, he will bid the cheapest bid in the longest minor.

BIDDING AN AGREED SUIT OR NO-TRUMP

- If the maximum of partnership points exceeds 32, bid 4 No-Trump (Blackwood).
- If the minimum number of partnership points exceeds 24 for major or No-Trump or 28 for minor, bid game (3 No-Trump, 4 major, 5 minor).
- If the maximum partnership points exceed 25 for major or No-Trump or 28 for minor, bid one less than game, if possible; if not, bid game. Otherwise, bid cheapest bid in suit. If bid is at game level, pass if last bid was in same suit.
- Otherwise, bid cheapest bid in suit. If last suit bid was same suit, pass.

TO SUMMARIZE FURTHER BIDDING

- If there is an agreed-upon suit, go to slam or game if enough points.
- If no agreed suit, try No-Trump.
- Otherwise, if you have enough points for game, keep bidding until you get to game.

See instructions for Bridge by ACTIVISION® for full details on bidding and playing procedures.

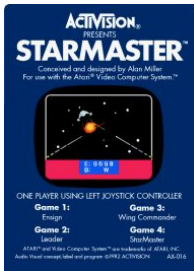

THE POWER OF STARMASTER™

Companion booklet

© 1982 Activision Inc.

ONLY AFTER MUCH TRAINING AND EXPERIENCE CAN YOU ASSUME THE POWER OF SUPREME STARMASTER™. LET THIS MANUAL BE YOUR GUIDE.

Your mission in StarMaster™ by Activision® is an extreme test of strategic, flying and combat skills. Learning the basics is just the beginning of your adventure.

You must possess a determination, skill, sensitivity and **power** beyond the ordinary to perform your mission quickly and efficiently. To sense danger, to be calm in the face of crises, to move from power to finesse with equal proficiency, to be the master of your ship and your galaxy – **this** is the challenge. This is **The Power of StarMaster™**.

STUDY. MASTER. BELIEVE. THE POWER CAN BE YOURS.

MEET MACC

Your on-board computer is code-named MACC – Mission/Attack Control Computer. He is an extension of your senses, monitoring the vital functions of your spacecraft. He is critical to the success of your mission.

ENERGY RESERVES

MACC provides you with a constant reading of your **energy reserves (E: ___)**. You should check this constantly. Firing your laser cannons, taking a hit from meteors or incoming enemy fire, travelling at warp speed from sector to sector, even cruising peacefully at normal speed – all cost you precious energy. **Do not be caught short!** Always leave enough to complete your mission or reach a starbase and refuel. If you run out of energy, your mission is ended.

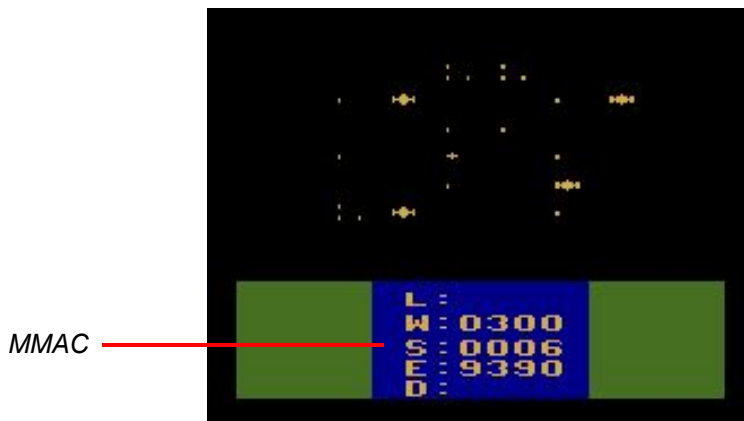

When you are selecting a sector to reach by warp travel, MACC will instantly calculate the energy needed to warp (**W: ____**). Be sure to check your energy reserves against the warp energy needed. Remember, the warp energy needed will be twice as high when warp engines are damaged.

Your mission evaluation is affected by how many times you have to dock with a starbase to refuel. Use your energy wisely for best performance.

STARDATE

MACC keeps you continuously informed of the elapsed time of your mission (**S: ____**) – Each Stardate represents about 4 seconds of Earth time. Your evaluation is affected by how long you take to complete your mission. Though this factor is not as critical as others in the final evaluation, **every second counts** when the enemy is closing in.

After much practice, you will develop a sense of how much time is necessary to complete a successful mission. Monitor your performance against that target as each mission progresses. Keep moving forward to complete your mission with all deliberate speed.

BE ALERT. BE RESPONSIVE. BE SURE.

DAMAGE CONTROL

This is MACC's most crucial function – to warn you when your ship has been damaged. When a damage alert sounds, MACC will instantly tell you the problem(s):

- L: Laser cannons destroyed.** You cannot fight the enemy, nor can you blast away meteors during warp travel. **Return to starbase immediately for repairs.**
- S: Shields destroyed.** This is the most dangerous and critical damage you can sustain. Your shields protect your ship from enemy fire and meteor collisions. When your shields are gone, one burst of energy fire or a collision with a meteor **will destroy your ship.**

This is a life and death situation and requires your immediate return to a starbase for repairs. **Do not continue to fight. Dodge all enemy fire. Steer past all meteors.**

- W: Warp engines damaged.** See "Energy Reserves". Don't be caught short. Leave enough fuel to make your way to a base for refueling.

- R: Radar damaged.** This is not a critical situation until you need to consult your Galactic Chart. With radar damaged, enemy fighters can no longer be detected and are not displayed on the Galactic Chart.

The only ways to locate the enemy after radar damage has been sustained are to (a) rely on your memory of enemy locations when you last consulted the chart or (b) return to a starbase to have the radar damage repaired. Since the enemy is constantly moving from sector to sector, relying on memory can be a hit-and-miss proposition. A return to base is almost always the wisest decision.

If radar damage occurs during a fight with the enemy, you usually can proceed to clear the sector of enemy fighters before returning to base, without any great risk.

STEADY ON THE STICK

Your spacecraft is a very sophisticated, sensitive and highly-maneuverable intergalactic spacecraft. It will respond very quickly to your movement of the D-Pad. Pressing UP will lower the nose of your ship; pressing DOWN will raise it. Pressing LEFT or RIGHT moves your ship in those directions.

Getting the **feel** of the controls is an important step to becoming a Supreme StarMaster. Take plenty of time to do so **before** you tackle a major mission. There will be times when your ability to steer your ship quickly, smoothly and accurately – while under intense pressure – will mean the difference between success and destruction.

THE STRATEGY OF THE SUPREME STARMASTER

How well you read, analyse and respond to the information on your ship's Galactic Chart will ultimately determine the speed and effectiveness with which you can complete your mission. Deciding which sectors of the galaxy to which to travel is a significant determinant of mission performance.

You must consider all of the following elements when consulting the chart:

1. Where are the enemy? Which starbases are in the greatest danger of being surrounded and destroyed?
2. How much energy is needed to warp to a sector – and how strong are your energy reserves?
3. How far can you go, how long can you fight, and how much enemy fire can you take with the energy reserves you have left?
4. Where are your starbases? Will you be able to get to one quickly if you're in trouble?

All of these factors must play a part in your selection. And, you must make your decision quickly and accurately for best results.

Be careful when you select a sector. Position the cross + accurately, before you press the A button to enter warp travel. Once you've pressed the A button, you can't turn back. Warping into an empty sector will cost you precious time and energy (although any sector is better than an enemy sector when your shields are damaged). Overshooting a starbase sector and entering an enemy sector when your ship is damaged could be devastating.

CONCENTRATE, BUT DON'T HESITATE. BE PRECISE, BUT ACT QUICKLY.

AT WARP SPEED

Don't allow the roar of your engines and the dazzling display of stars streaking past your ship's windows to lull you into a false sense of security during warp travel. There's danger in the galaxy – meteors which can seriously damage your ship before you've even begun to fight. These meteors also can destroy your ship if your shields are damaged.

Your best strategy is always to steer around these meteors. If you must destroy one with your laser cannons, you will consume precious energy. A collision with a meteor both drains your energy and can damage your ship.

ENGAGING THE ENEMY

High-speed battle with deadly enemy starfighters requires the utmost in concentration, reflexes, flying skill and marksmanship. Your ship is equipped with two front-mounted, medium range laser cannons. These weapons are calibrated so that their beams intersect precisely at the area centered on your gunsights.

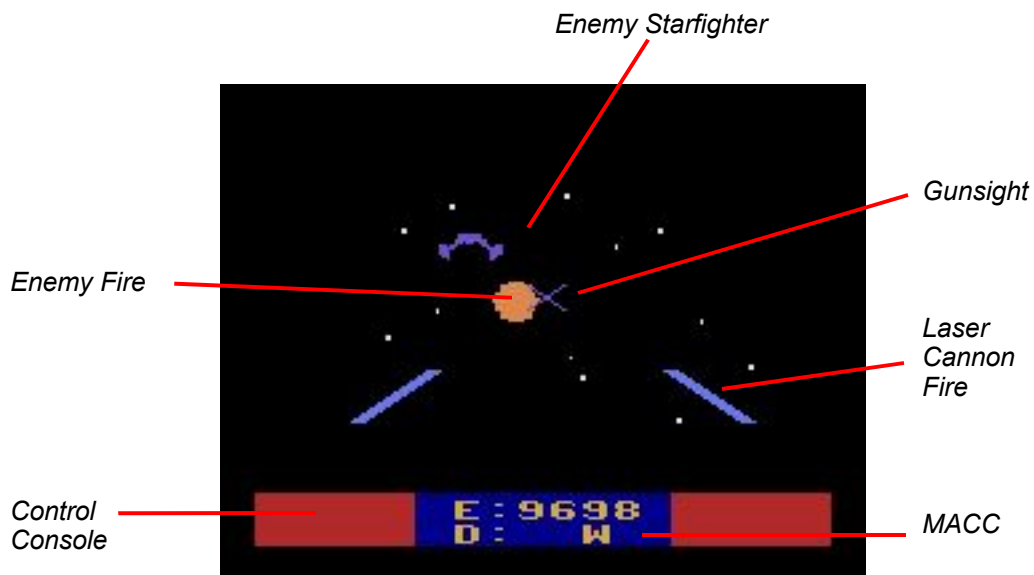

Your ship's cannons are effective **only** when the enemy is in range (visible) and centered in your sights. Likewise, you can only destroy incoming fire when it is centered in your sights. Firing wildly into space will only waste precious energy.

Quick and careful control of your D-Pad is required to keep the enemy in your sights and insure maximum laser cannon effectiveness.

CONCENTRATE. CONTROL. MASTER.

COLORS ARE VERY SIGNIFICANT

Enemy ships explode in a burst of **red** when hit by your fire.

Enemy fire explodes in a burst of **blue** when you successfully intercept it with your cannons.

A **yellow** explosion signifies that your ship has been hit by enemy fire or meteors.

And, of course, MACC lights your control panel with colors signifying the status at the sector in which you are flying:

Green: a clear sector.

Red: enemy fighters present.

Blue: a starbase is in the sector.

You must be aware of – notice – interpret **everything** to reach the status of Supreme StarMaster.

YOUR STARBASES

The targets the enemy ultimately seeks are your starbases. They know that by surrounding and destroying your starbases, they can ultimately destroy you. The enemy is always on the attack, no matter where you are or what you're doing. They are relentless in their pursuit of your bases.

At the start of each mission, you have four starbases located strategically in the galaxy.

They never move – they are always in place – unless the enemy destroys them.

Know where your starbases are. Monitor the enemy's movements carefully. You are the only defense for your bases.

DOCKING WITH A STARBASE

Your mission evaluation is maximized when you complete the mission with a minimum number of dockings. Nevertheless, only the most skilled of the StarMaster corps will be able to complete a full mission – destroy all enemy fighters – without at least one docking.



Docking with a starbase is one of the most sensitive maneuvers in StarMaster. Each base is in an elliptical orbit within its sector and will approach you and recede from you as you pilot through the sector.

Docking is completed when the approaching starbase is centered within your ship's sights at its closest approach. **You must relax**, no matter how intense the pressure, and ease your ship carefully into place. Be gentle, but sure, in your control of the D-Pad. A confident hand at the controls is all that is necessary.

Practice until you can dock quickly, without missing. Your mission and the security of your bases may depend on it.

Remember, your starbases are under constant attack and can even be destroyed right before your eyes.

BE QUICK. BE SURE. MASTER THE POWER.

ENTERING "THE ORDER OF SUPREME STARMASTER"

Tips from Alan Miller, designer of StarMaster™

Alan Miller is a Senior Designer at Activision. A fierce video game competitor, he's also the designer of Checkers, Tennis and Ice Hockey by ACTIVISION®.

"StarMaster is a game that requires the mastery of a wide variety of skills to achieve the best performance. Careful analysis of all information, good strategic planning, the skilled control of a master pilot and accurate marksmanship in the heat of battle are all needed to succeed.

"A Supreme StarMaster will have lightning-quick reactions, a keen eye, a clear head and the ability to remain calm and in control at all times.

"A Supreme StarMaster will use all the tricks available to complete a successful mission. Use your D-Pad controls to dodge meteors, don't try to destroy them with your cannon unless absolutely necessary.

"Pick your targets carefully and keep your laser fire to a minimum. Do not fear enemy fire. Keep your cool and dodge incoming fire whenever possible. Get a clear shot at the enemy before firing.

"Many of us at Activision have practiced long hours to reach the level of Supreme StarMaster. I hope you enjoy the challenge.

"Please drop me a note and report on your missions. I'd love to hear from you."

SUPPLEMENTARY TIPS AND CHEATS

ACTIVISION® DECATHLON

During the Pole-Vault, tap the A button a few times rapidly to release the pole (instead of just once). You'll go higher.

BASEBALL

Begin game play in two player mode. Hold the A button as your team is leaving the field in preparation to bat. The opposing pitcher will automatically throw a strike for the first pitch, setting up an easy hit.

DRAGSTER™

Here's a piece of advice if you want to make any progress with this game: Always release the gas pedal (the A button) while shifting gears (by pressing LEFT on the D-Pad). Pressing both at the same time will automatically blow your engine. This simple yet essential detail is not clearly mentioned in the manual of the game.

ICE HOCKEY

Start the game. When the whistle blows, hold the A button and then press DOWN on the D-Pad. If you man picks up the puck, he will shoot it off the rink and toss it directly in the computer's goal. It takes practice to get this to work repeatedly.

KABOOM!™

Score at least 10,000 points to put a surprised expression on the Mad Bomber's face.

It's possible to "beat" the game by achieving 999,999, the maximum score. The only manner in which this can possibly be done is as follows: Trail the Mad Bomber everywhere he goes, accurately duplicating every single move he makes and therefore arriving at each latitude a split-second after he's been there (and hence catching every bomb). This takes a lot of practice and isn't as much fun as just trying to follow the trails of bombs, but for you dogged members of the Bucket Brigade: It can be done.

LASER BLAST™

Just get the pattern down. It doesn't take much practice, and it's simple to execute: Immediately position your ship all the way up and directly over the left base's starting point. Now fire three shots: the first straight downward as soon as each wave begins, taking out the lefthand base, and the next two diagonally to the right, blasting the others as they move into your laser's path. You don't have to move your ship at all (in fact, this will be detrimental); remember that when the A button is down, you're in aiming mode and your ship won't move. The only way to get killed once you've acquired the feel for this pattern is to stray from it or wait too long at any given point.

Quickly fire to remain in "aim" mode, to prevent being moved up after hitting the three tanks.

OYSTRON

This seems to be a good strategy: stay on the right part of the playfield, off the pearls zone, shooting left and right. Collect pearls here and when you've enough of them, rush down and complete an entire row.

There's only one kind of enemy (except the Oystron itself) that can jump from a row to another; however, they will never jump on a row already occupied by something else. So when these enemies come out, busy rows are usually a safe place to stay.

SKIING

Switch the Left Difficulty switch from **B** to **A** and back to **B** (by holding the L button and pressing LEFT on the D-Pad) to re-center your skier.

SPIDER FIGHTER™

Set the Left Difficulty switch to **A** (the hard setting) and begin game play. Set the switch back to **B** during game play to earn the extra points allowed under the hard difficulty setting while actually playing under the easy difficulty setting.

STAMPEDE™

Roll over the score to display steer heads instead of numbers.

TENNIS

Having trouble scoring on your opponent? Try running and hitting the ball with the far edge of the racket. The ball will fly across the court!

APPENDIX B

GAME MAPS

**H.E.R.O.
MAPS**
PAGE 1 OF 13

Level 1



Level 2

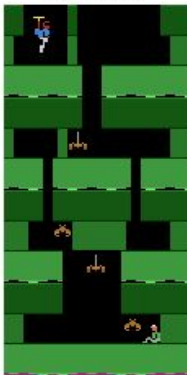

Level 3

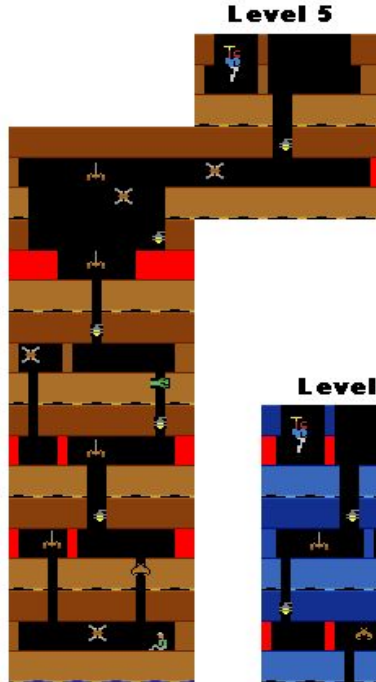
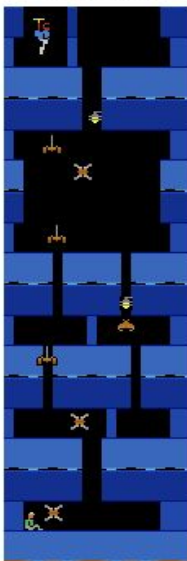

Level 4



Level 7

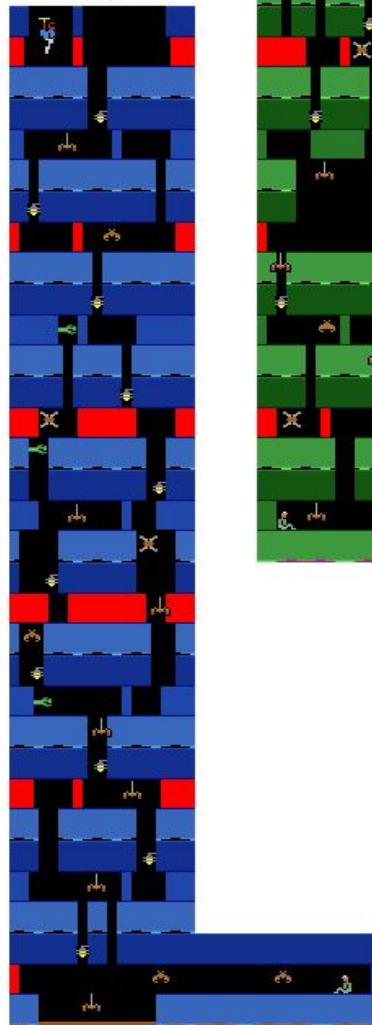

Level 6



**H.E.R.O.
MAPS**
PAGE 2 OF 13

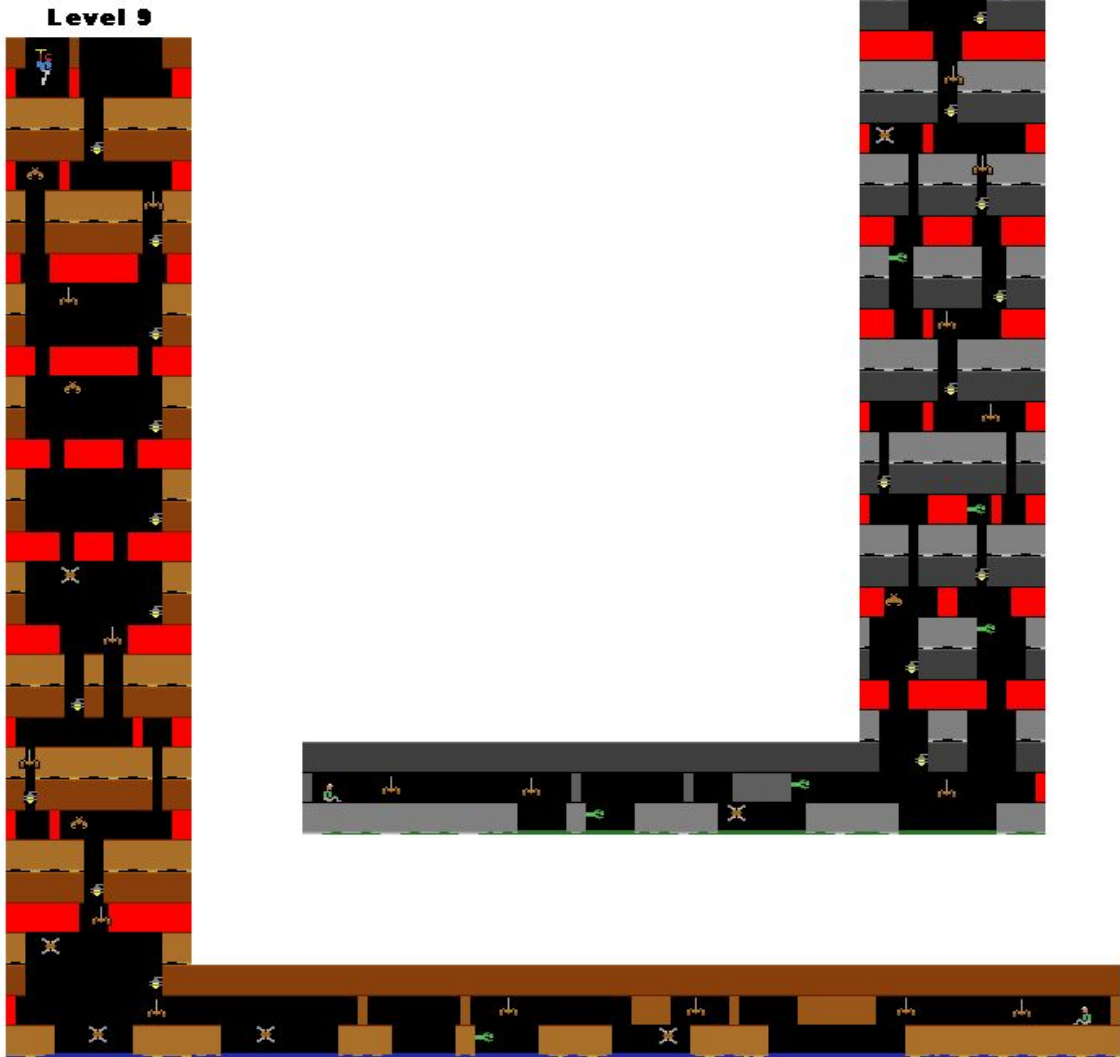

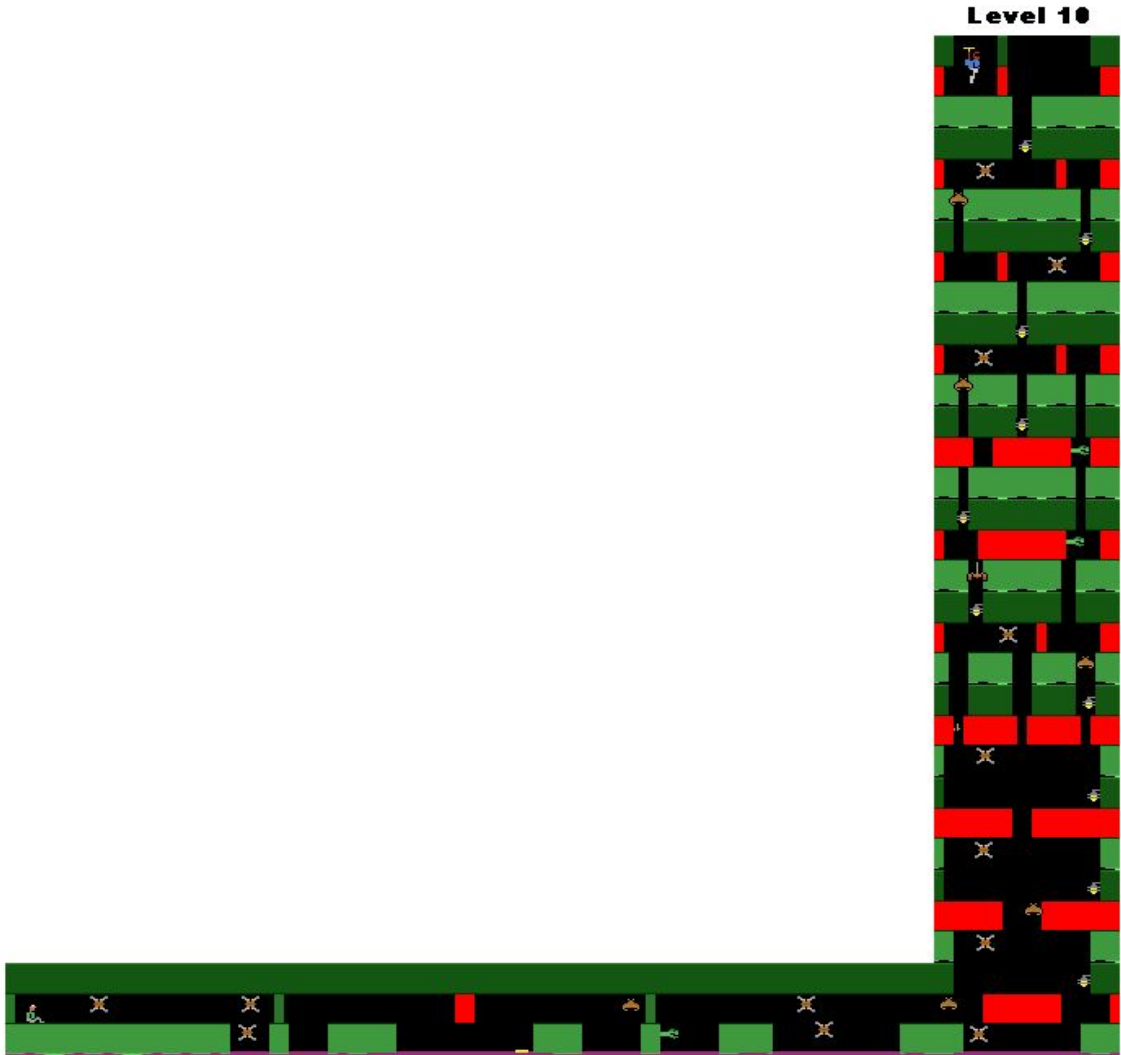

Level 11

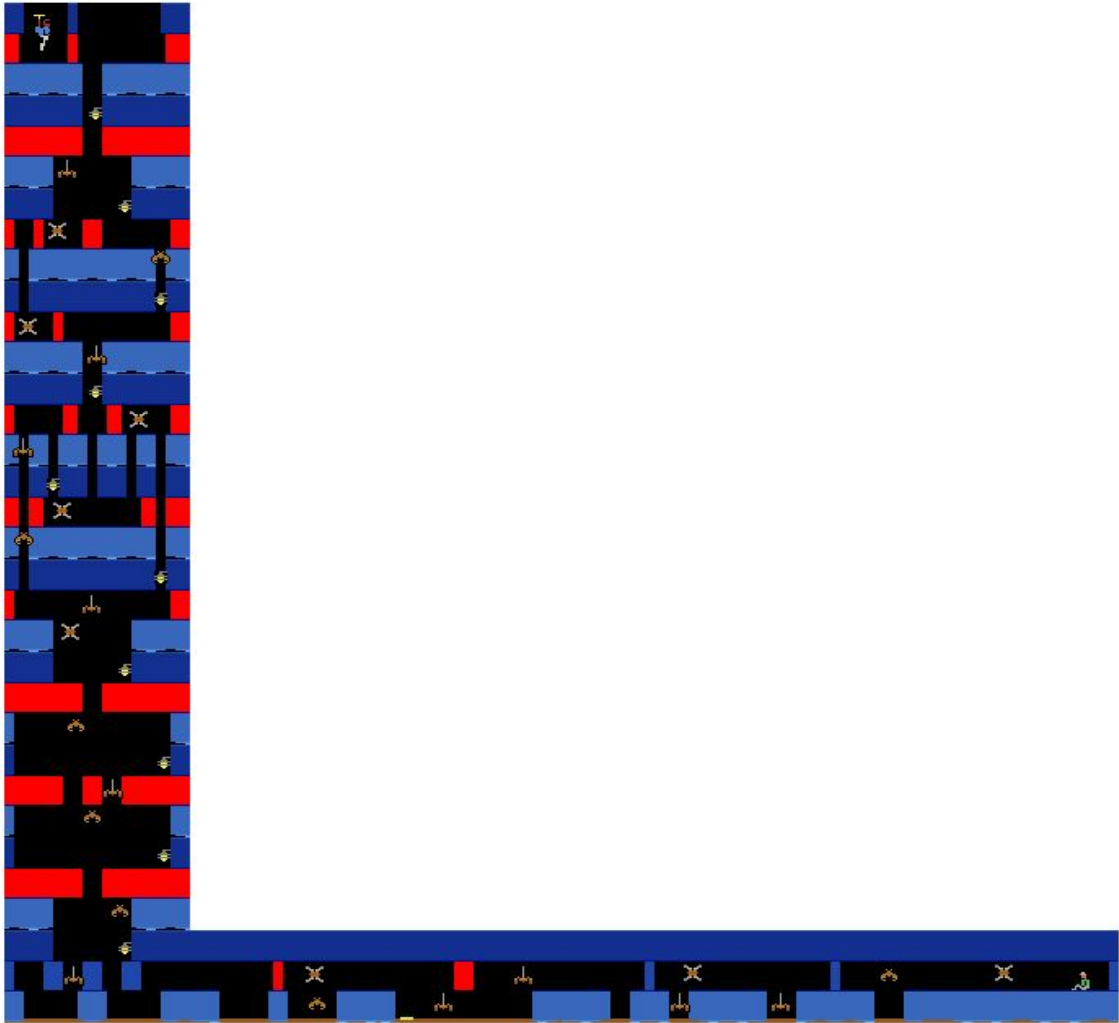

Level 12

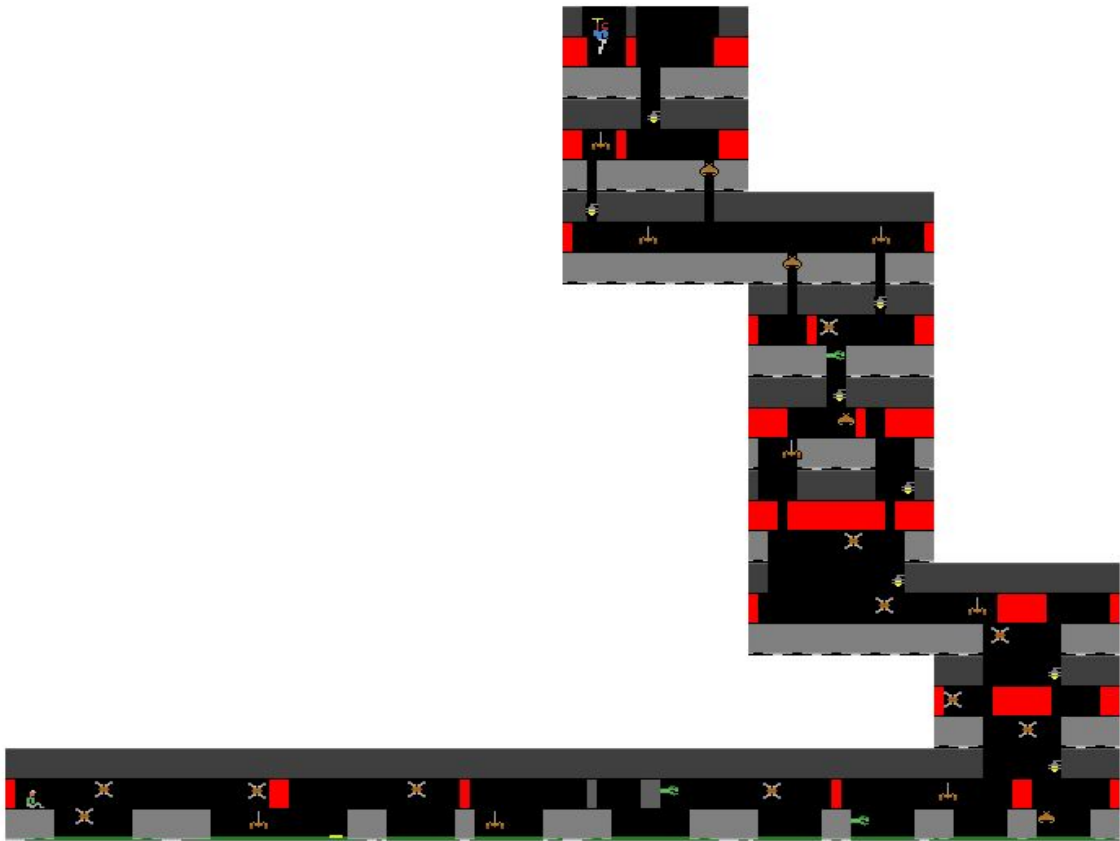

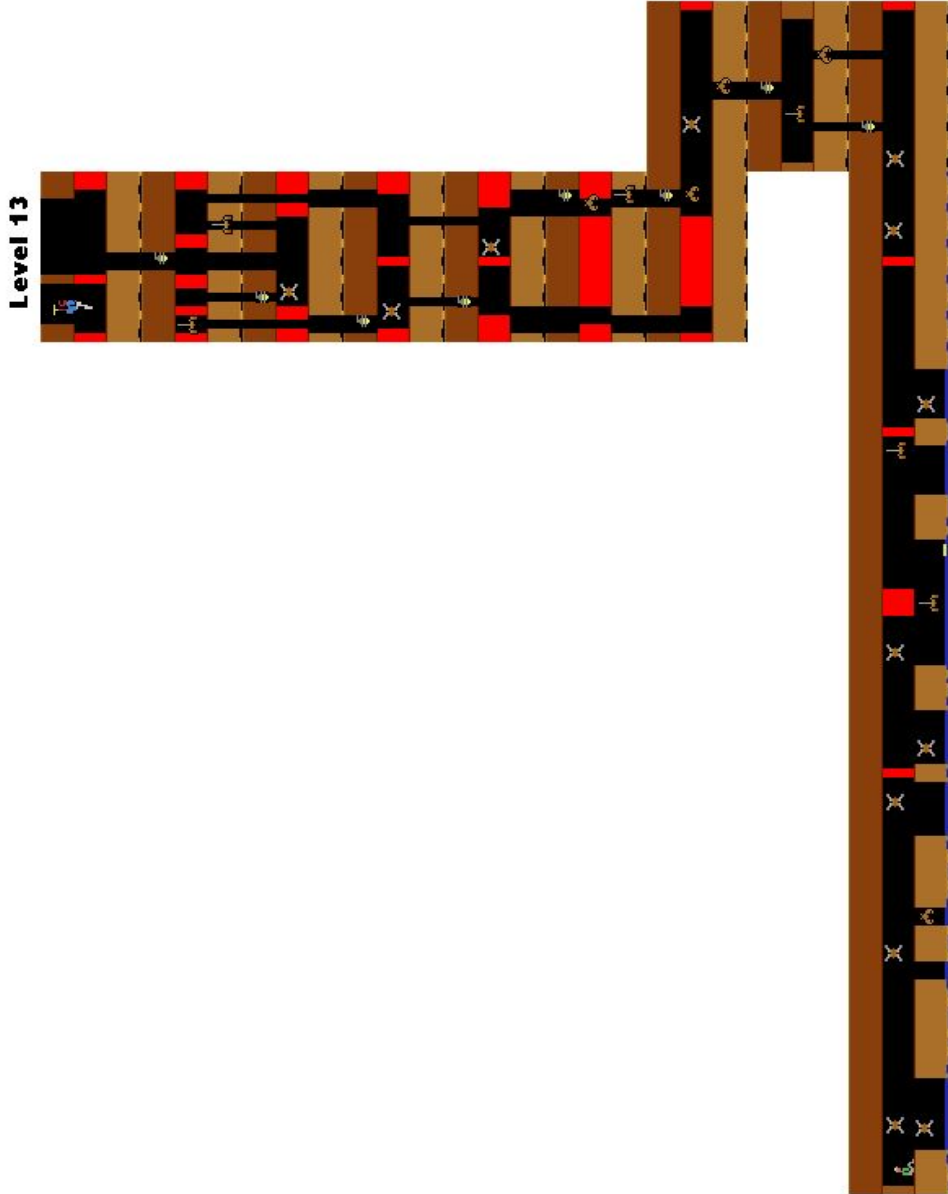

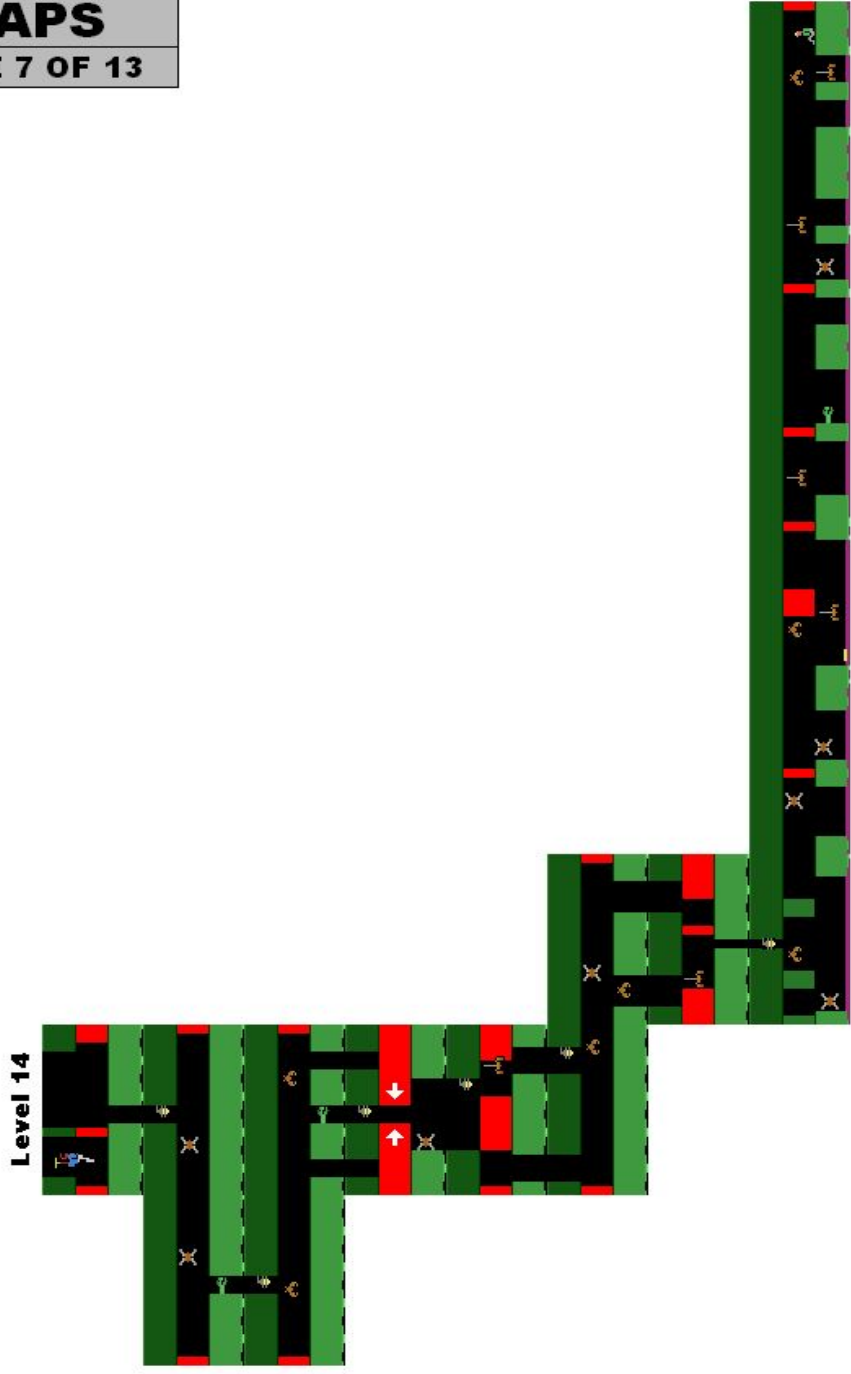

Level 15

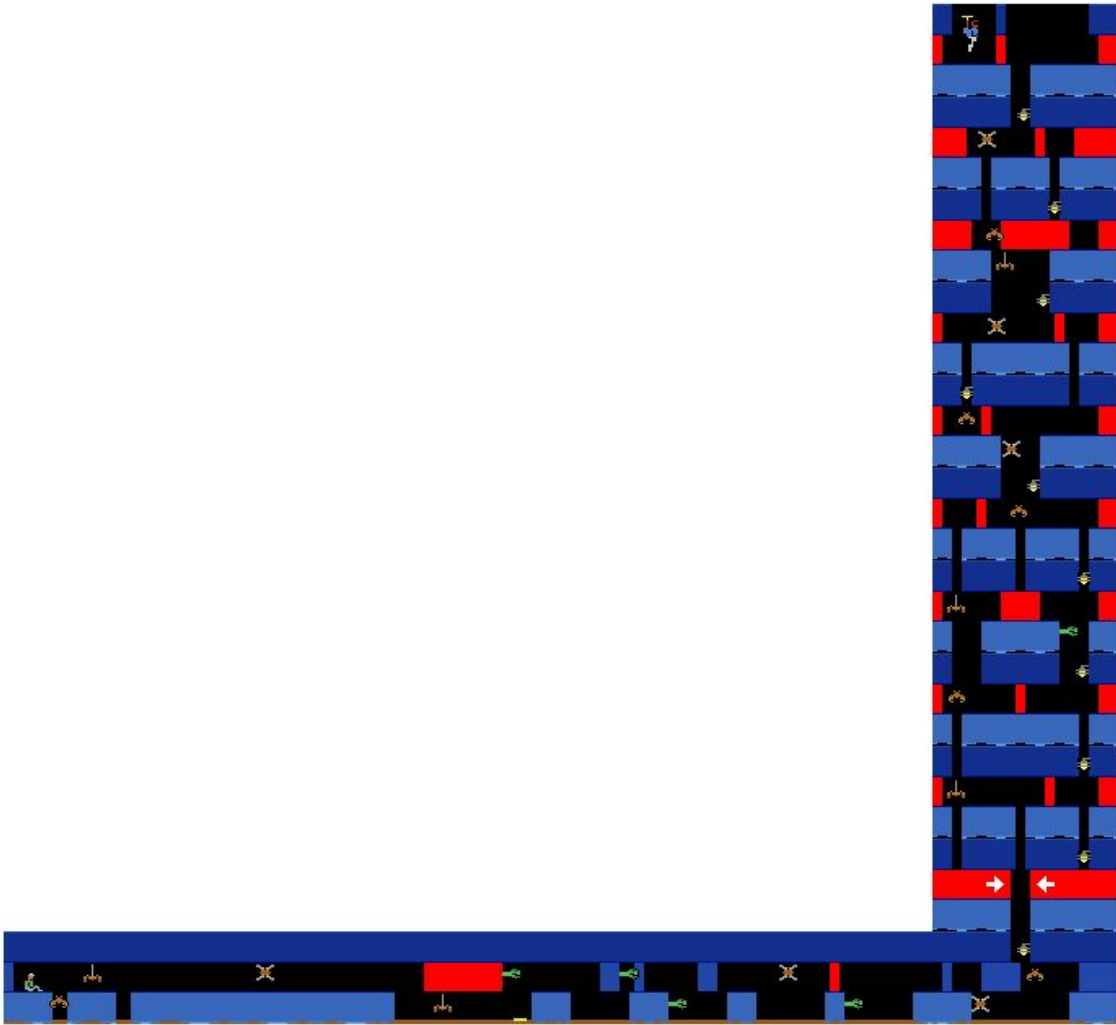

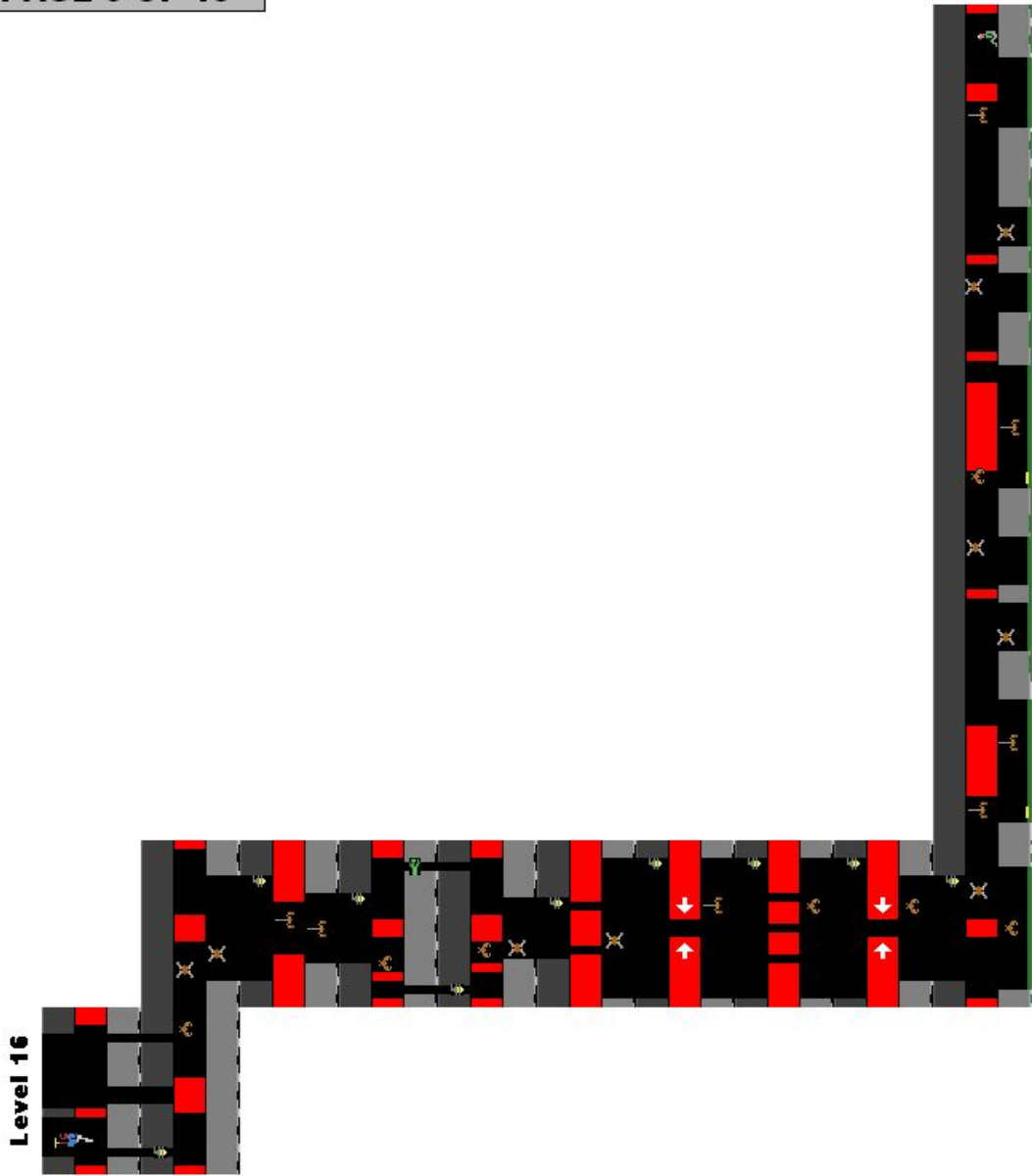

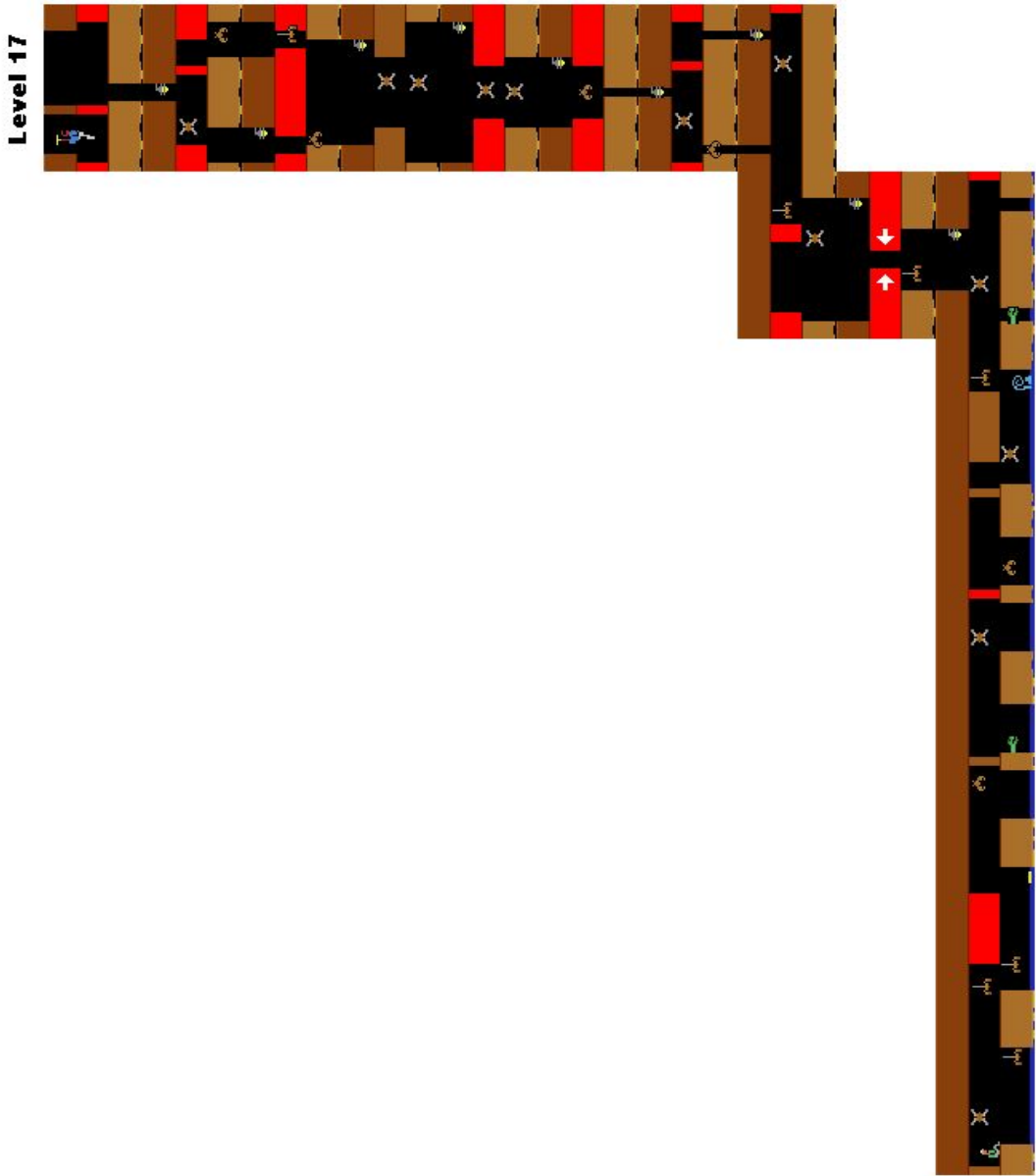

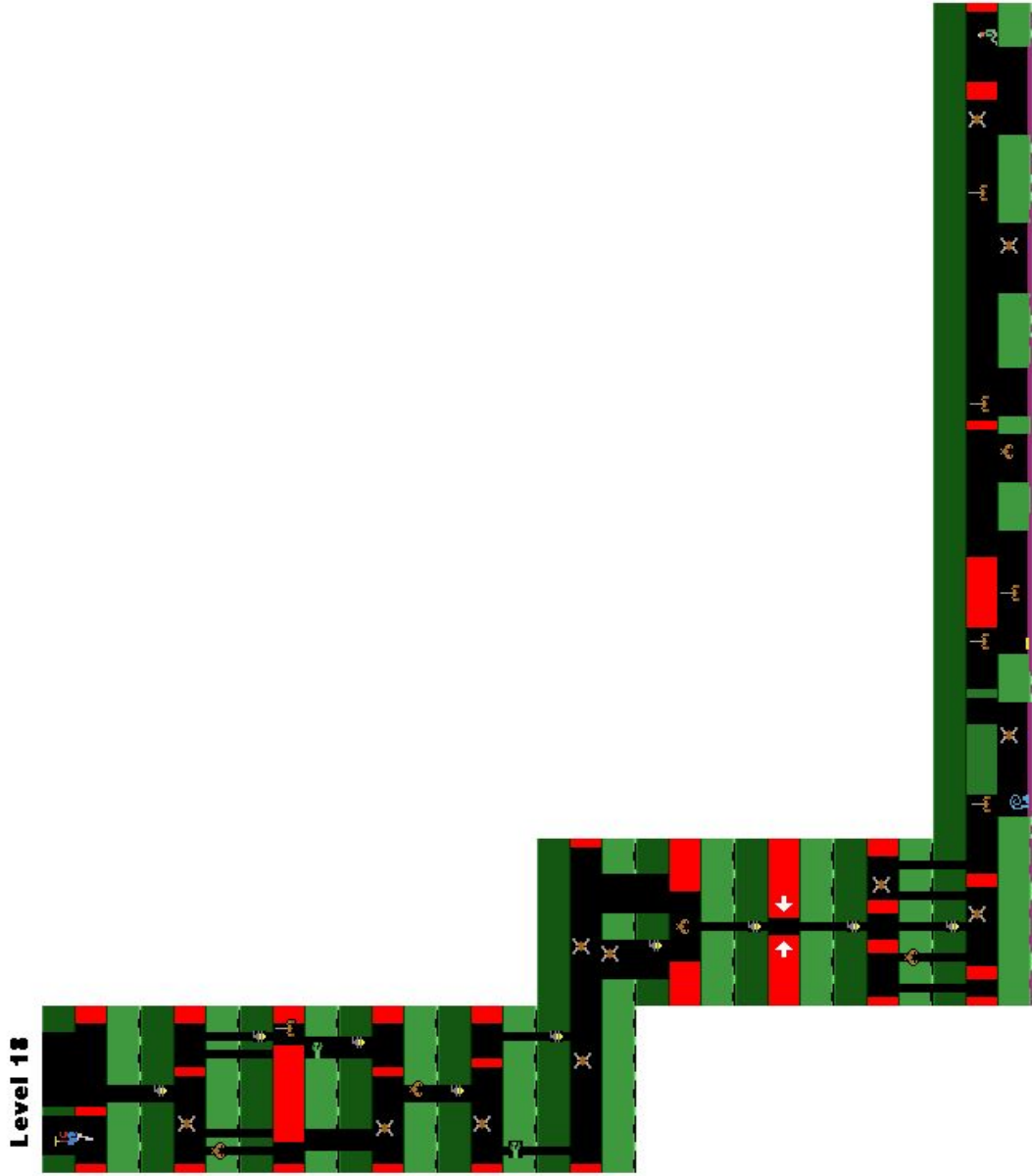

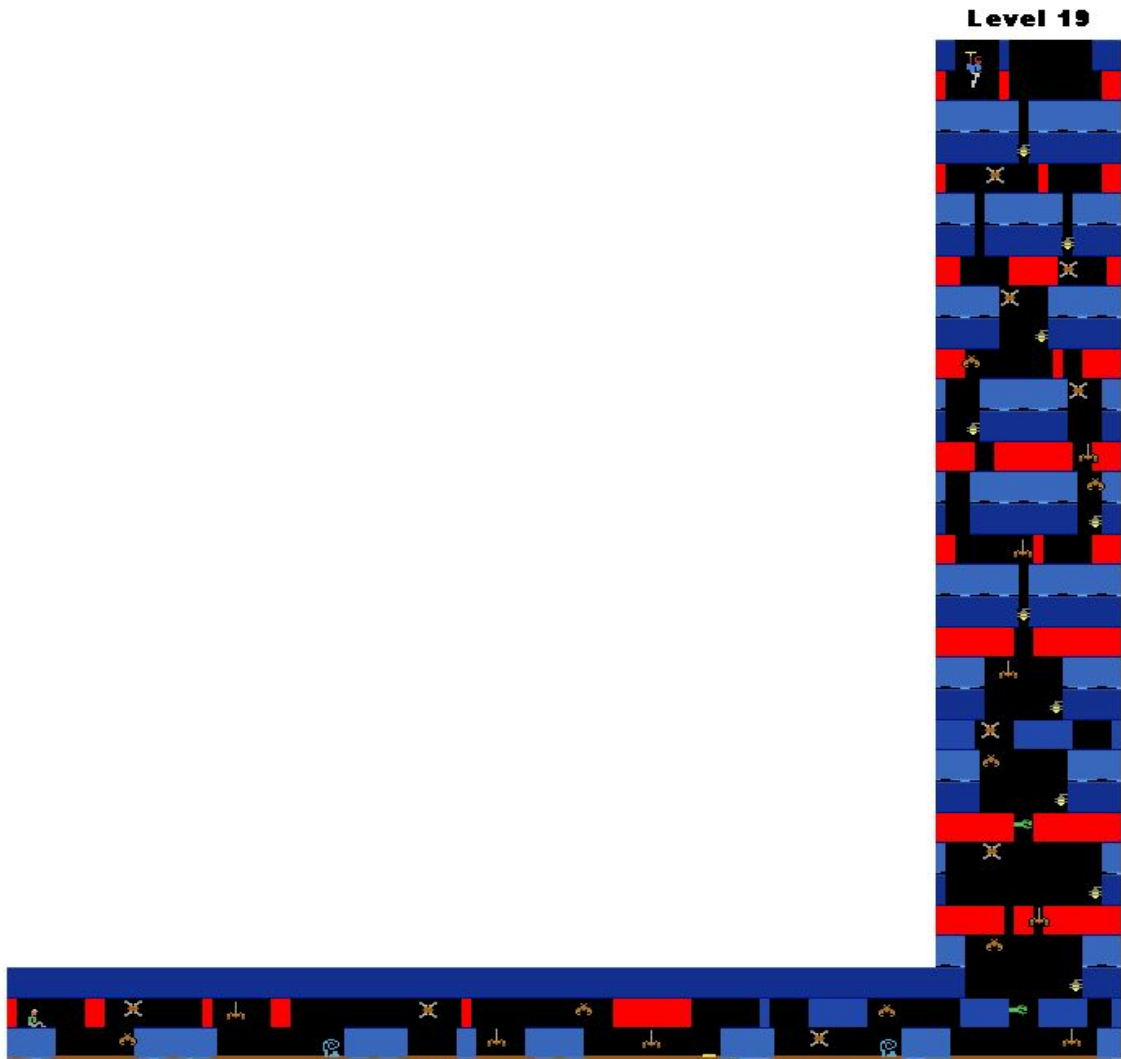

**H.E.R.O.
MAPS**
PAGE 13 OF 13

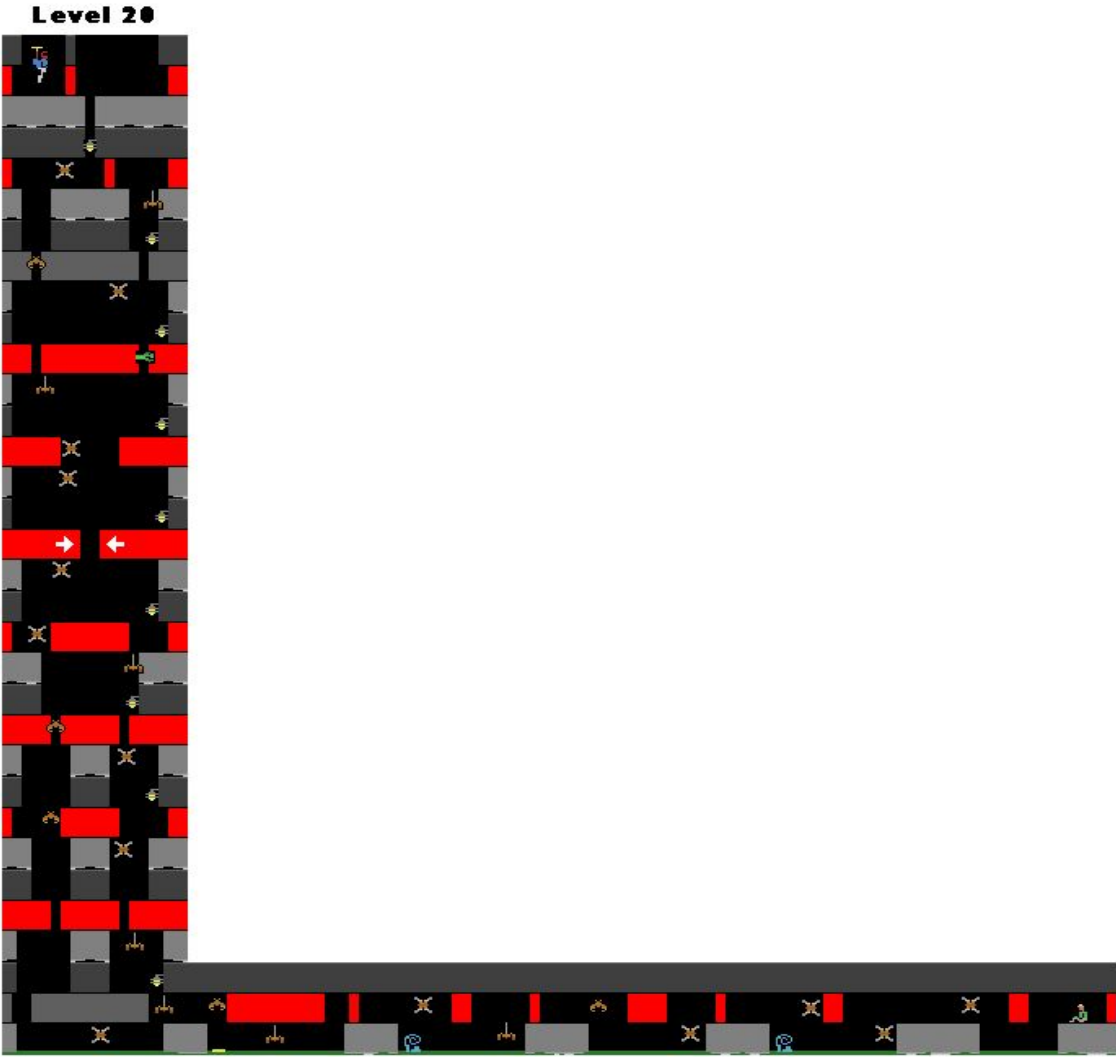

PITFALL MAP

Vine, Tar pit, Crocodiles, Snake, Silver bar, Dead end
 Ladder, Pond, Scorpion, Fire, Diamond ring
 Shifting tar pit or pond, Rolling log, Gold bar, Money bag

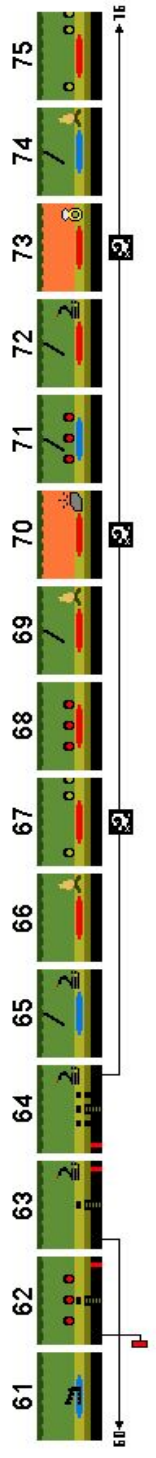
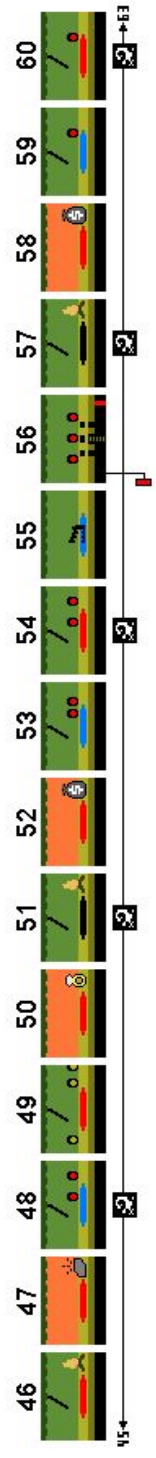
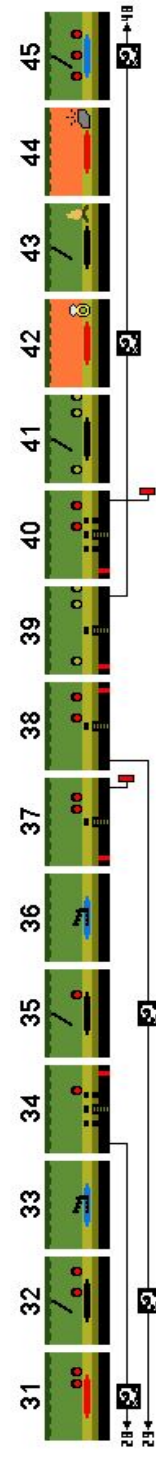
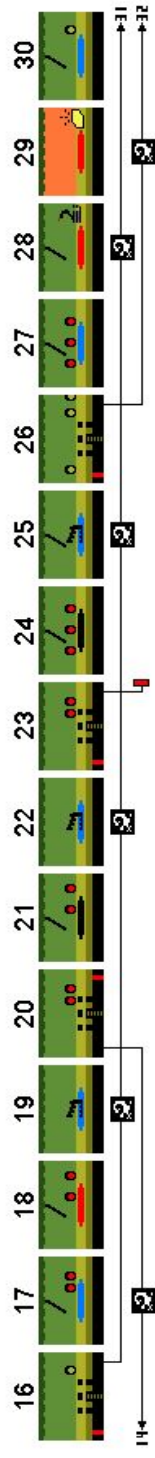
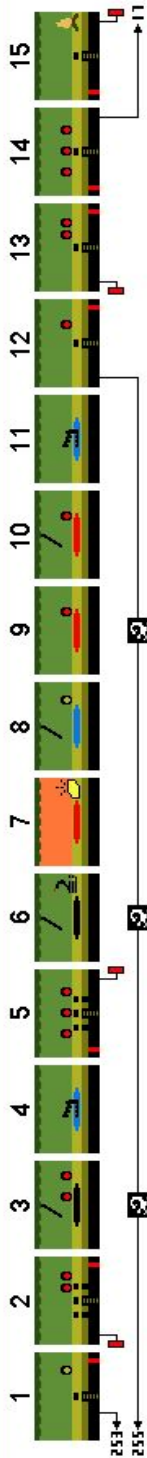

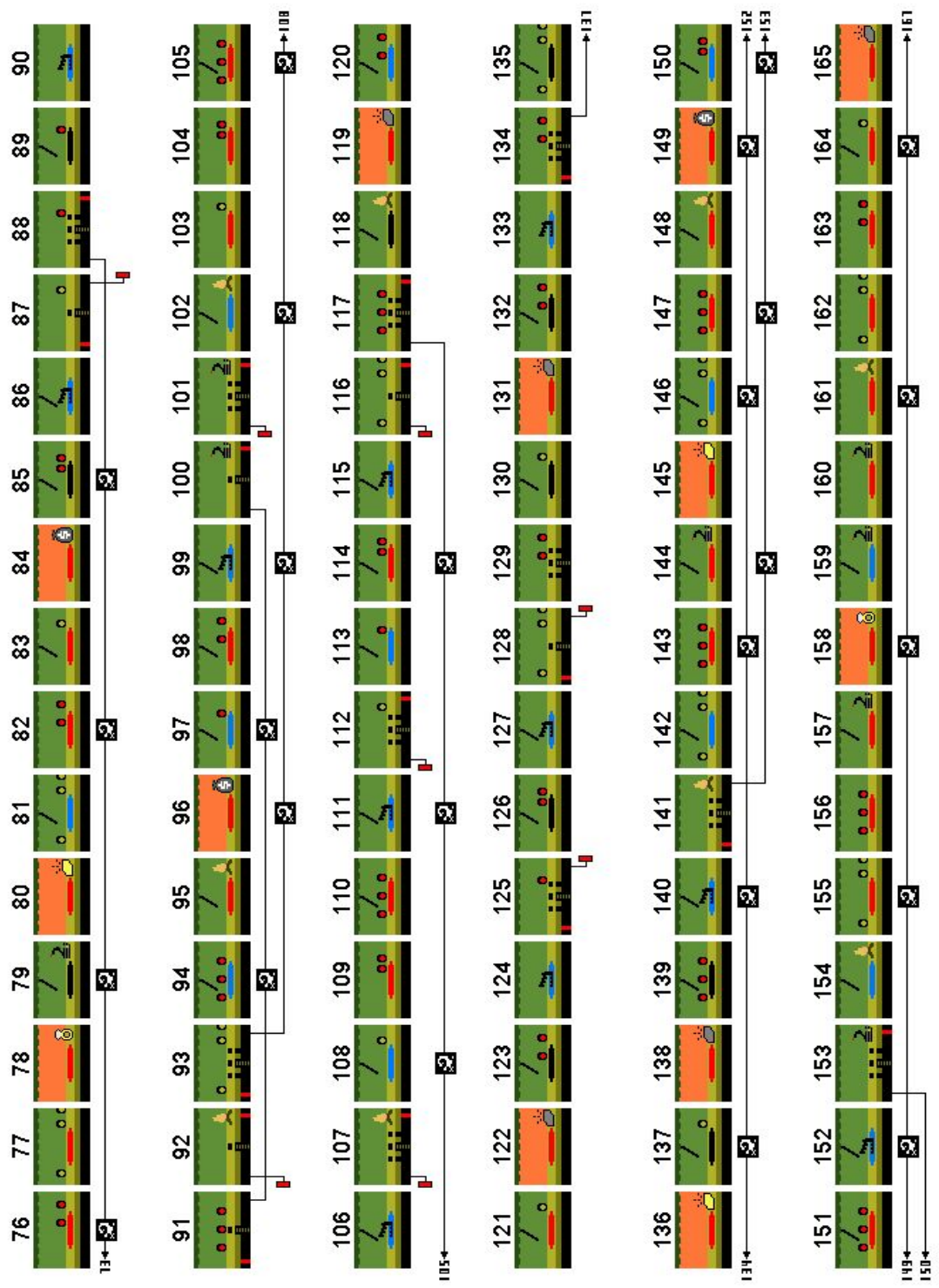

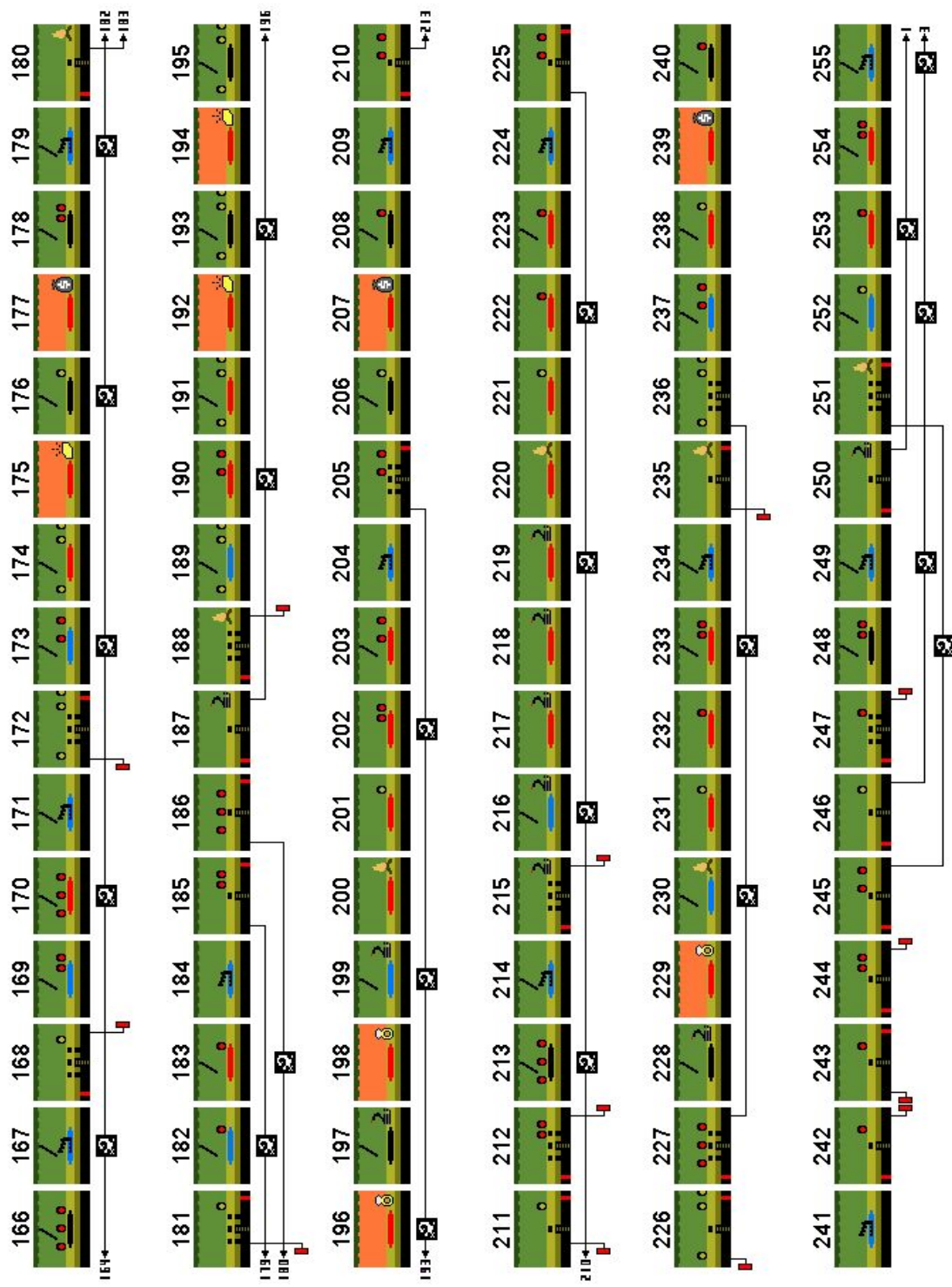

PITFALL II

MAP OF THE LOST CAVERNS

LEGEND

- Rhonda
- Raj Diamond
- Quickclaw
- Rat
- Gold Bar
- Red Cross

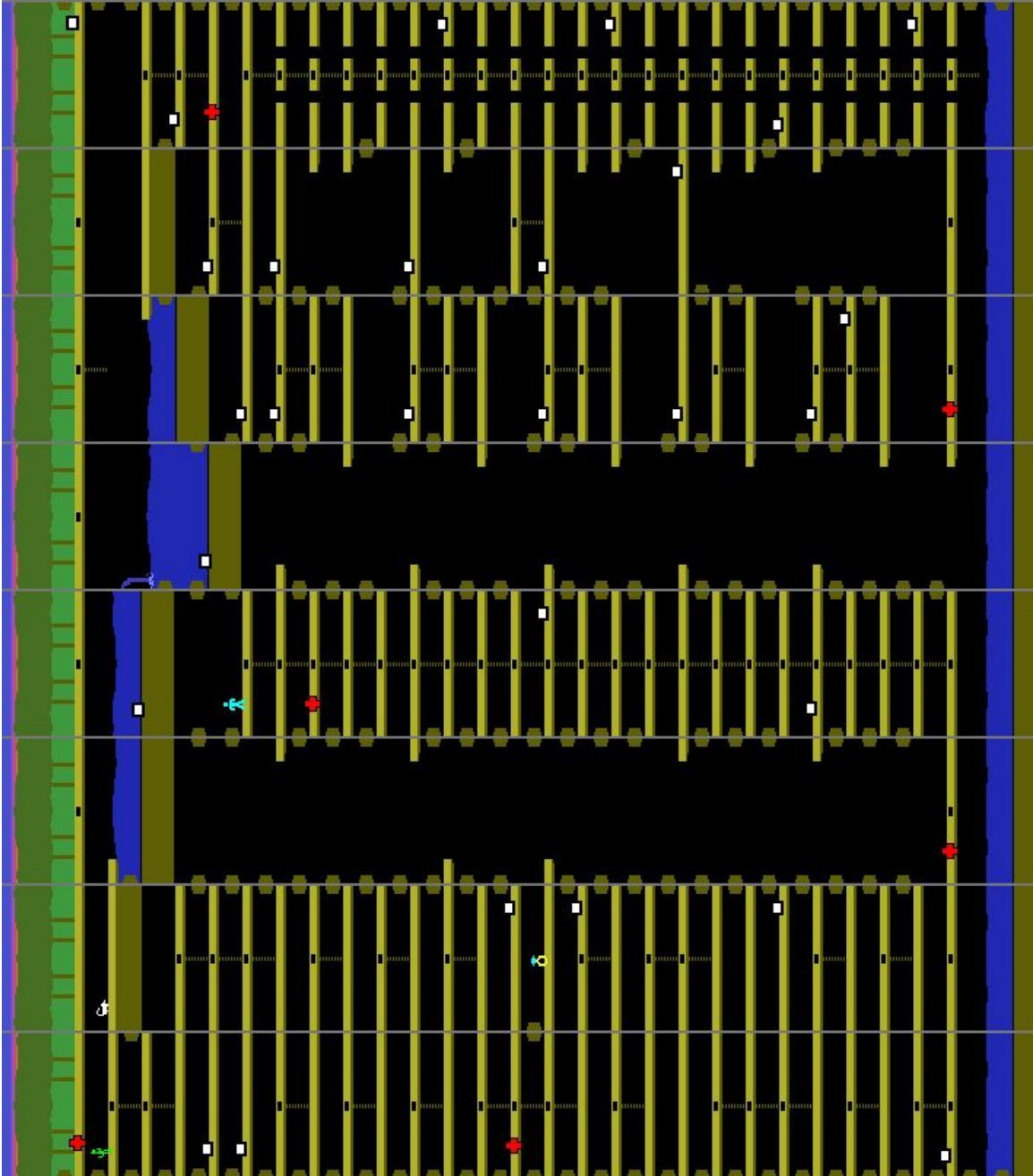

PRIVATE EYE - CITY MAPS
CASE 1: "Safecracker Suite"

-  Falling Flower Pots
-  Falling Bricks
-  Pot Hole
-  Questionable Character
-  Thug with Dagger
-  Barrier (Jump!)
-  Bird
-  Rat
-  Road Block

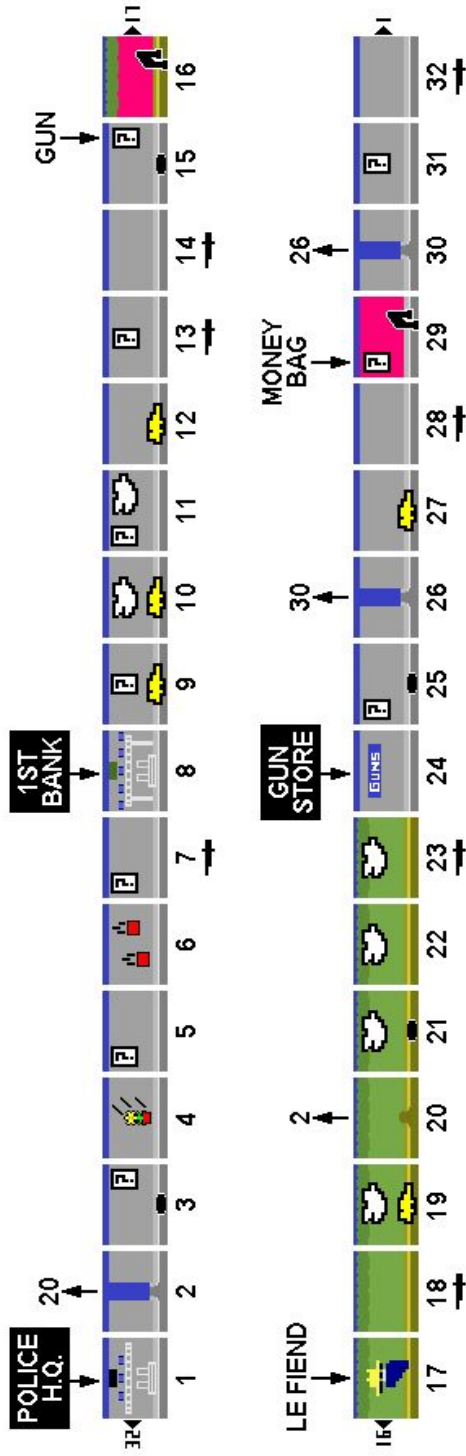

PRIVATE EYE - CITY MAPS
CASE 2: "Closed on Mondays"

-  Falling Flower Pots
-  Falling Bricks
-  Pot Hole
-  Questionable Character
-  Thug with Dagger
-  Barrier (Jump!)
-  Bird
-  Rat
-  Road Block

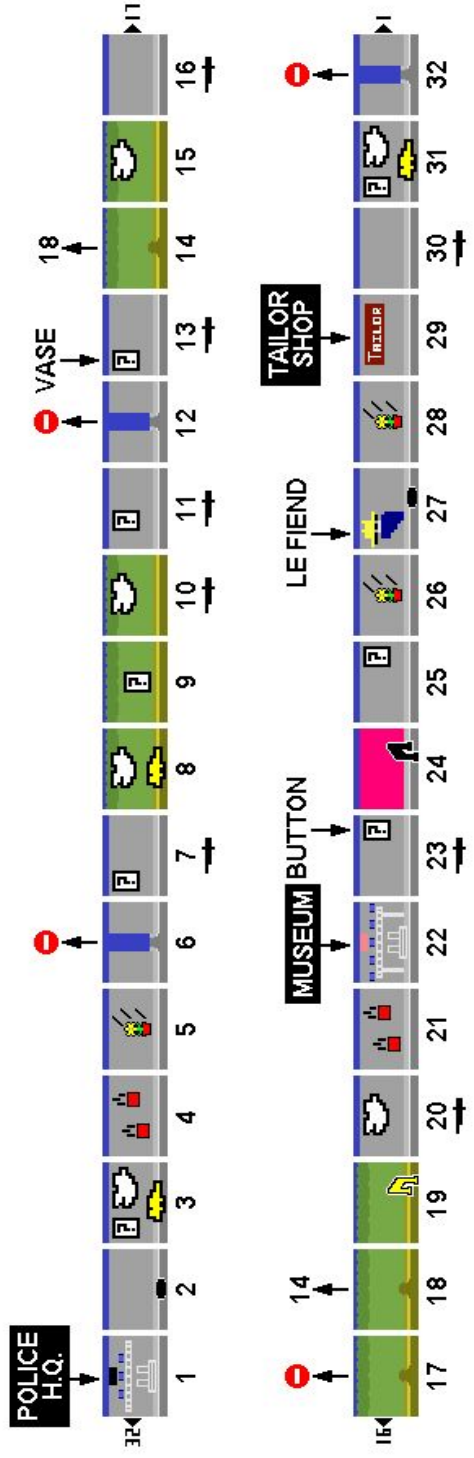

PRIVATE EYE - CITY MAPS
CASE 3: "Dealing in Diamonds"

-  Falling Flower Pots
-  Questionable Character
-  Bird
-  Falling Bricks
-  Thug with Dagger
-  Rat
-  Pot Hole
-  Barrier (Jump!)
-  Road Block

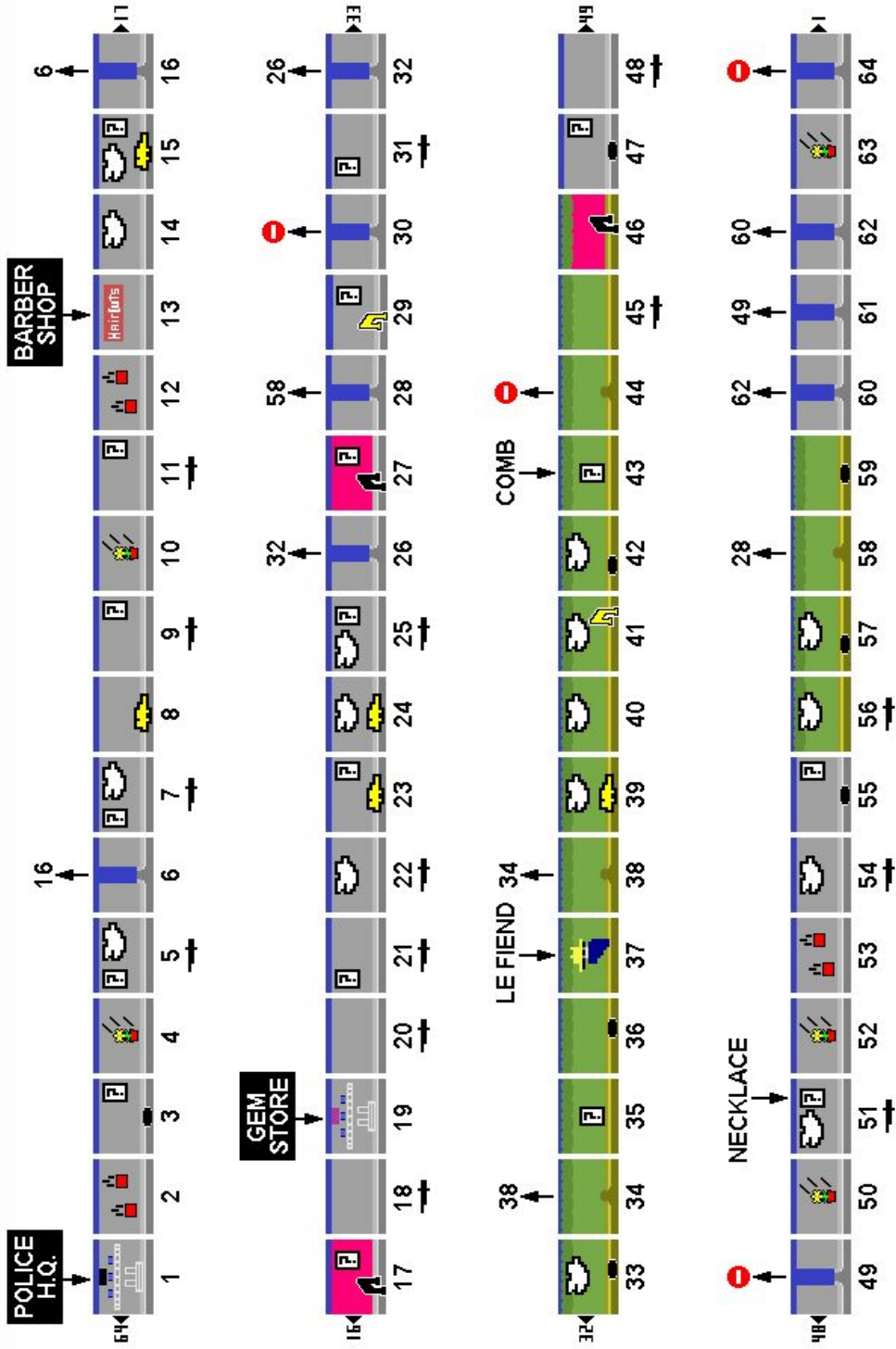

PRIVATE EYE - CITY MAPS
CASE 4: "Rare Stamp Roulette"
 Page 1 of 2

-  Falling Flower Pots
-  Falling Bricks
-  Pot Hole
-  Questionable Character
-  Thug with Dagger
-  Barrier (Jump!)
-  Bird
-  Rat
-  Road Block









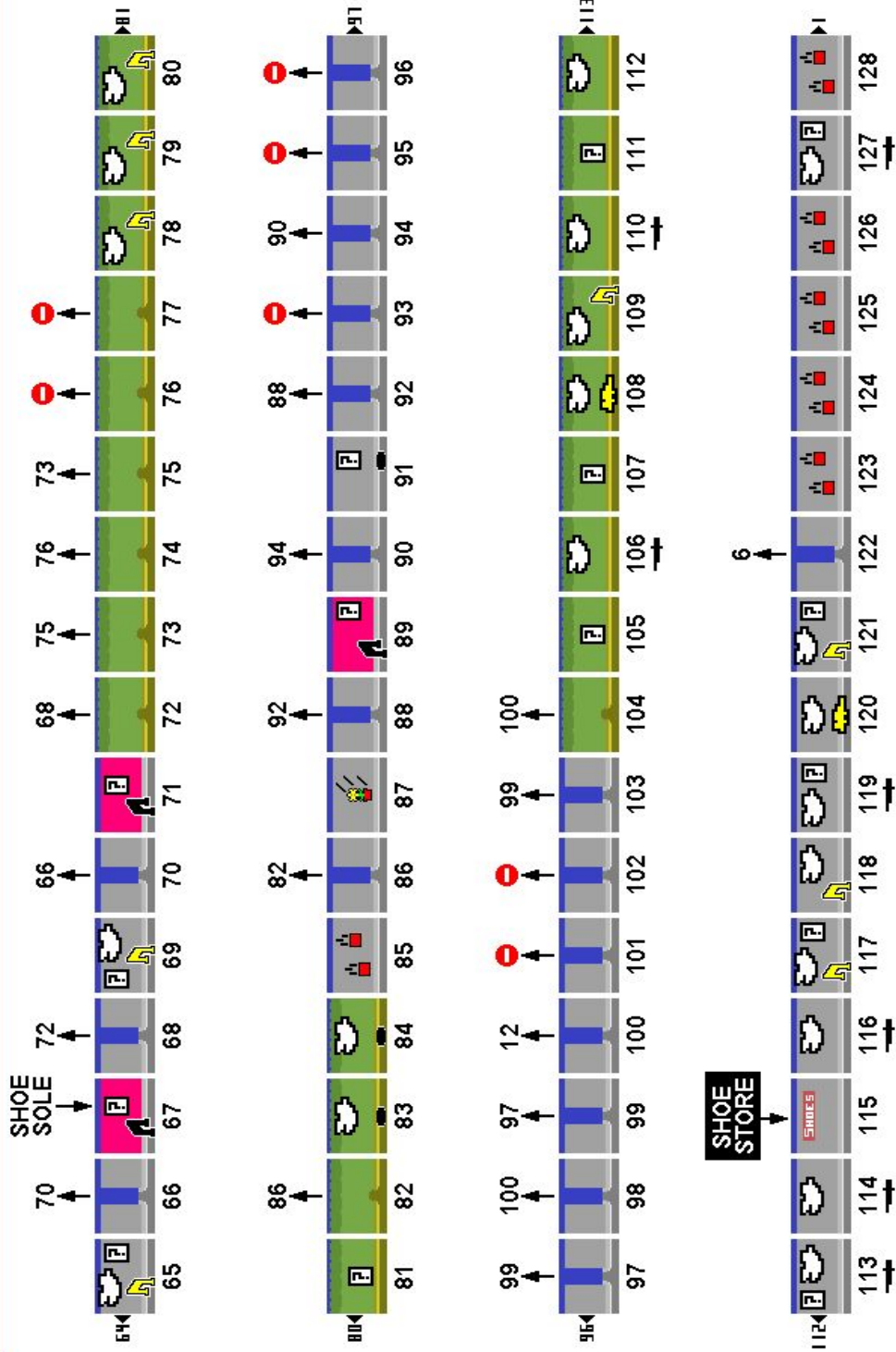

PRIVATE EYE - CITY MAPS
CASE 4: "Rare Stamp Roulette"

Page 2 of 2

-  Falling Flower Pots
-  Questionable Character
-  Bird
-  Falling Bricks
-  Thug with Dagger
-  Rat
-  Pot Hole
-  Barrier (Jump!)
-  Road Block







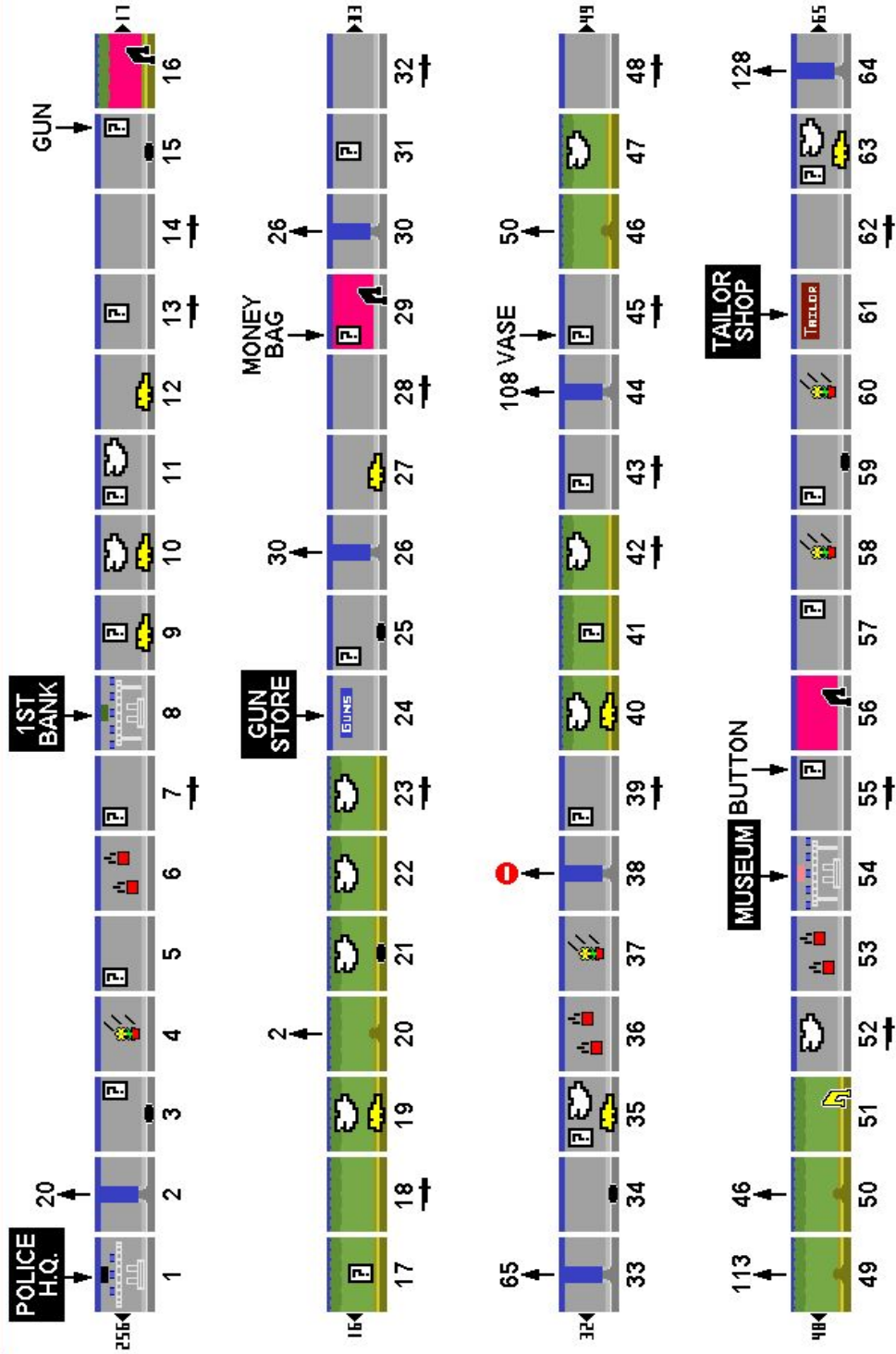



PRIVATE EYE - CITY MAPS
CASE 5: "The Big Sweep"
 Page 1 of 4

-  Falling Flower Pots
-  Questionable Character
-  Bird
-  Falling Bricks
-  Thug with Dagger
-  Rat
-  Pot Hole
-  Barrier (Jump!)
-  Road Block







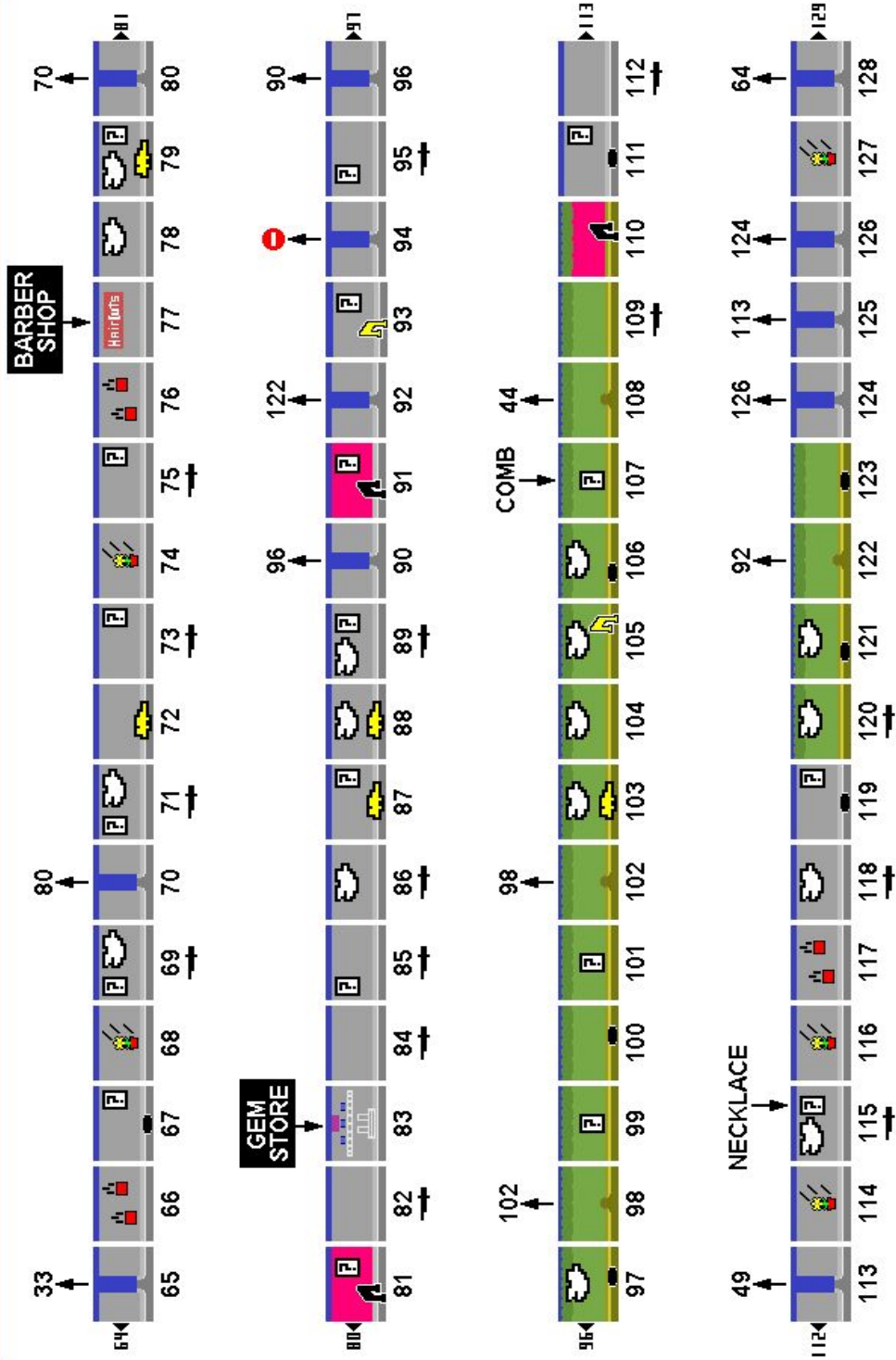



PRIVATE EYE - CITY MAPS
CASE 5: "The Big Sweep"
 Page 2 of 4

-  Falling Flower Pots
-  Falling Bricks
-  Pot Hole
-  Questionable Character
-  Thug with Dagger
-  Barrier (Jump!)
-  Bird
-  Rat
-  Road Block







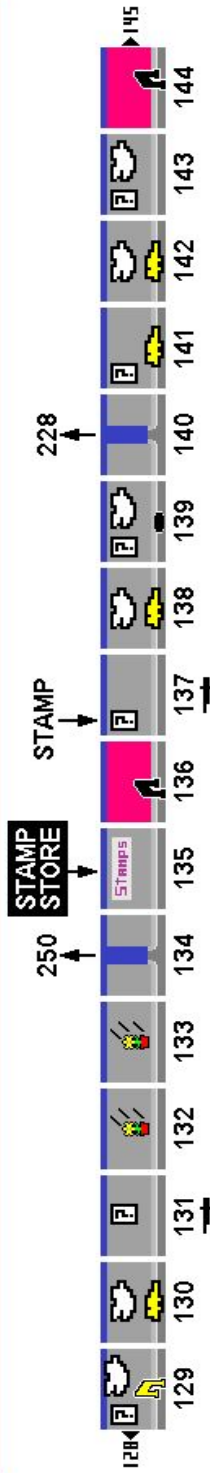



PRIVATE EYE - CITY MAPS
CASE 5: "The Big Sweep"
 Page 3 of 4

-  Falling Flower Pots
-  Falling Bricks
-  Pot Hole
-  Questionable Character
-  Thug with Dagger
-  Barrier (Jump!)
-  Bird
-  Rat
-  Road Block



PRIVATE EYE - CITY MAPS
CASE 5: "The Big Sweep"

Page 4 of 4

-  Falling Flower Pots
-  Falling Bricks
-  Pot Hole
-  Questionable Character
-  Thug with Dagger
-  Barrier (Jump!)
-  Bird
-  Rat
-  Road Block

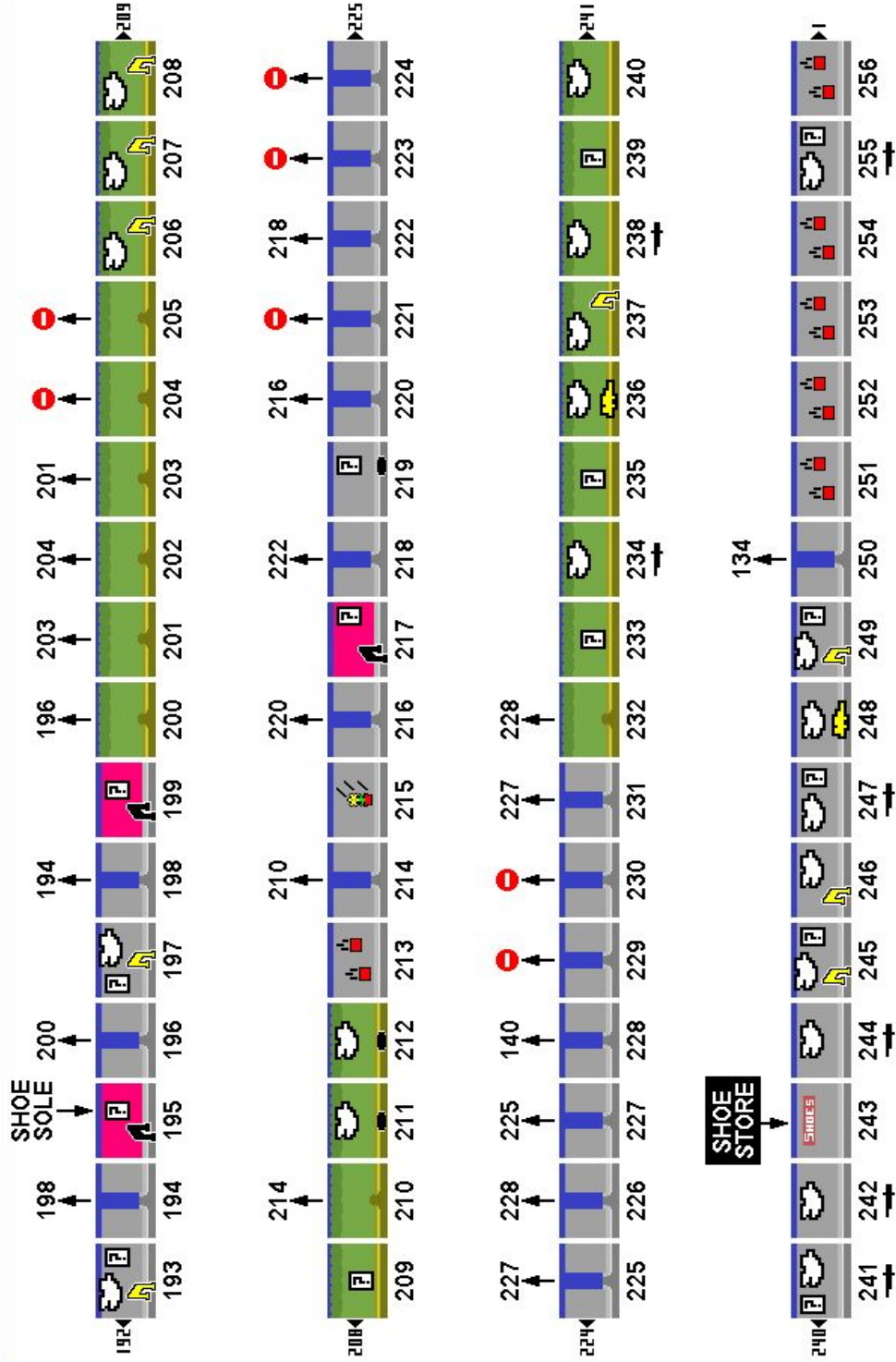

SKATE BOARDIN' CITY MAP

Ramp  Tube  Hurdle 

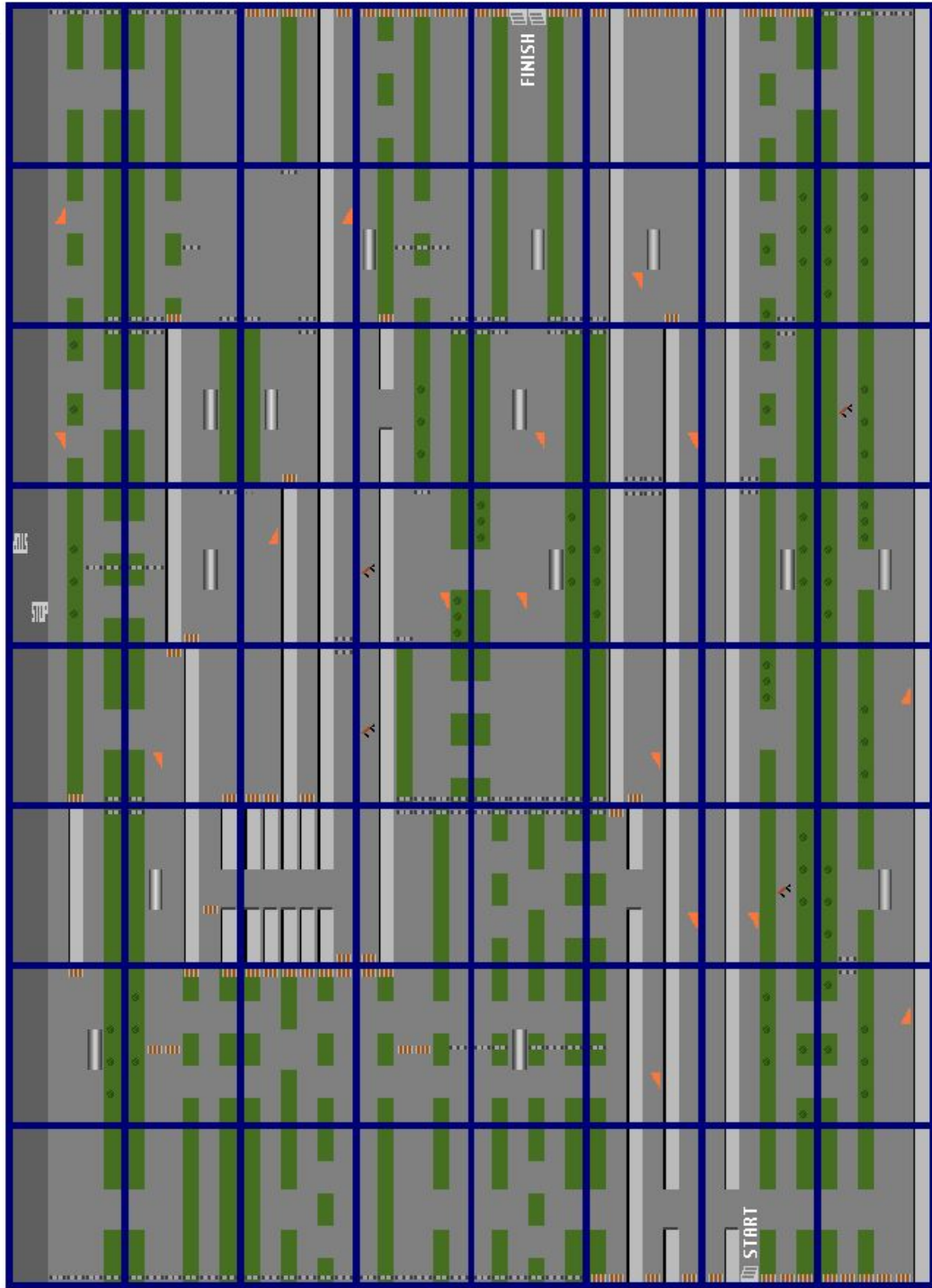

APPENDIX C

REQUIREMENTS FOR EARNING PATCHES

REQUIREMENTS FOR EARNING PATCHES

Game	Requirement
Barnstorming	Game 1: 33.3 seconds or less, or Game 2: 51.0 seconds or less, or Game 3: 54.0 seconds or less
Beamrider	40,000 points at sector 14
Chopper Command	10,000 points
Crackpots	75,000 points
Decathlon	Bronze Medal: 8,600 points Silver Medal: 9,000 points Gold Medal: 10,000 points
Dolphin	Friends of Dolphin: 80,000 points Secret Society of Dolphins: 300,000 points
Dragster	6.0 seconds or less
Enduro	Survive five days or more
Freeway	Game 3 or 7: 20 points
Frostbite	40,000 points
Grand Prix	Game 1: 0:35 or less, or Game 2: 1:00 or less, or Game 3: 1:30 or less, or Game 4: 2:30 or less
H.E.R.O.	75,000 points
Ice Hockey	Beat the computer (Game 1)
Kaboom!	3,000 points
Keystone Kapers	35,000 points
Laser Blast	Federation: 100,000 points Million: 1,000,000 points
Megamania	45,000 points
Oink!	25,000 points
Pitfall!	20,000 points

REQUIREMENTS FOR EARNING PATCHES (cont.)

Game	Requirement
Pitfall II	99,000 points
Plaque Attack	35,000 points
Pressure Cooker	45,000 points
Private Eye	Solve case #3
River Raid	15,000 points
Robot Tank	Merit: 48 tanks Cross: 60 tanks Star: 72 tanks
Seaquest	50,000 points
Skiing	Game 3: 28.2 seconds or less
Sky Jinks	Game 1: 37.0 seconds or less, and no missed pylons
Space Shuttle	Pilot: 5 docks and 4,500 fuel units Commander: 6 docks and 7,500 fuel units
Spider Fighter	40,000 points
Stampede	3,000 points
StarMaster	Ensign (Game 1): 3,800 points Leader (Game 2): 5,700 points Wing Commander (Game 3): 7,600 points StarMaster (Game 4): 9,000 points
Tennis	Beat the computer

APPENDIX D

CREDITS AND ACKNOWLEDGEMENTS

CREDITS AND ACKNOWLEDGEMENTS

First and foremost, I would like to thank the good folks at AtariAge.com, namely **Albert Yarusso** and **Alexander Bilstein**, for making such a great Atari site. AtariAge helped tremendously in the making of this compilation of instruction manuals. To say it made my work a lot easier is an understatement.

Also a special "thank you" goes to **Greg Chance**, who originally assembled many of the text manuals found on AtariAge today.

Some other credits due (*very sorry if any names are missing*):

- **Graham J. Percy**, for transcribing the manuals of Baseball, Beamrider and H.E.R.O..
- **Dean St-Antoine**, for transcribing the manual of Bridge.
- **Galen Komatsu**, for transcribing the manual of Cosmic Commuter.
- **Dave Giarrusso**, who wrote, designed and illustrated the manual for Kabobber. (Nice work, BTW!)
- **Eddie Beiles**, for transcribing the manual of Robot Tank.
- **K. Gifford**, for transcribing the manual of Skate Boardin'.

Also, I would like to thank **John McLeod**, who allowed me to use the rules of bridge available on his *Card Games* web site, found at <http://www.pagat.com> .

And last but certainly not least, I would like to thank all the people at Aspyr Media for making *Activision® Anthology* for the Game Boy® Advance. This includes all the people who worked on it closely or indirectly. Awesome work, guys!